

Raymarine®



AIS700

Troubleshooting Guide

English (en-US)
Date: 05-2020
Document number: 82418-1
© 2020 Raymarine UK Limited

Trademark and patents notice

Raymarine, Tacktick, Clear Pulse, Truzoom, SeaTalk, SeaTalk^{hs}, SeaTalkng, and **Micronet**, are registered or claimed trademarks of Raymarine Belgium.

FLIR, LightHouse, DownVision, SideVision, RealVision, HyperVision, Dragonfly, Element, Quantum, Axiom, Instalert, Infrared Everywhere, The World's Sixth Sense and **ClearCruise** are registered or claimed trademarks of FLIR Systems, Inc.

All other trademarks, trade names, or company names referenced herein are used for identification only and are the property of their respective owners.

This product is protected by patents, design patents, patents pending, or design patents pending.

Fair Use Statement

You may print no more than three copies of this manual for your own use. You may not make any further copies or distribute or use the manual in any other way including without limitation exploiting the manual commercially or giving or selling copies to third parties.

Software updates



Check the Raymarine website for the latest software releases for your product.
www.raymarine.com/software

Product documentation



The latest versions of all English and translated documents are available to download in PDF format from the website: www.raymarine.com/manuals.
Please check the website to ensure you have the latest documentation.

Publication copyright

Copyright ©2020 Raymarine UK Ltd. All rights reserved.

Contents

Chapter 1 Important information	7
FCC	8
Compliance Statement (Part 15.19)	8
FCC Interference Statement (Part 15.105 (b))	8
Innovation, Science and Economic Development Canada (ISED)	8
Innovation, Sciences et Développement économique Canada (Français)	8
Water ingress	9
AIS disclaimer	9
Disclaimer	9
Product disposal	9
Warranty registration	10
Technical accuracy	10
Chapter 2 Document and product information	11
2.1 Troubleshooting	12
2.2 Applicable products	12
2.3 Compatible Raymarine displays	12
2.4 Compatible 3rd party displays	14
2.5 Software updates	14
Chapter 3 Troubleshooting	17
3.1 Power up troubleshooting	18
3.2 AIS data troubleshooting	18
Configuration	19
VHF antenna specification	21
3.3 VSWR Alarm troubleshooting	22
3.4 Data conflicts and data loops	22
3.5 LED Status indicator	22
Chapter 4 Technical support	25
4.1 Product returns process	26
4.2 Raymarine product support and servicing	26
Appendix A MMSI Regulatory bodies and application submissions	29

Chapter 1: Important information



Warning: Configure before use

Before use this product must be correctly configured using a personal computer and the supplied proAIS2 software that can be downloaded from the Raymarine website.

- Failure to configure the product will prevent correct operation.
- Configuration **MUST** include programming the product with an MMSI number.
- Incorrect / incomplete configuration can cause erroneous data and prevent your product from transmitting.
- If an MMSI number is not programmed the product will operate as an AIS receiver only and will not transmit AIS information about your vessel.



Warning: VHF antenna

Ensure that your VHF antenna meets the requirements of the VHF antenna specification, which can be found in the product documentation.

- Using an antenna optimized for only AIS frequencies may damage the product.
- Using an antenna optimized for only VHF frequencies may cause erroneous alarms.
- Using an old antenna with degraded performance will result in reduced AIS performance.
- New VHF antennas are sold with a fixed cable length. Cutting the cable of a new antenna can affect its performance and result in a high VSWR ratio and limited reception.



Warning: GNSS (GPS) antenna

- To enable the AIS to function, the supplied GNSS (GPS) passive antenna **MUST** be installed and connected.
- Ensure that the installation location has a clear line of sight to the sky.



Warning: Grounding stud connection

Energy generated by Near-lightning strikes (NLS) and atmospheric static build-up can be conducted by the product, via the VHF antenna. To ensure that this energy is safely discharged the grounding stud located on the top of the product **MUST** be connected to the vessel's grounding point.

Failure to connect the grounding stud to the vessel's grounding point may cause permanent damage to the product and invalidate your product's warranty.



Warning: Product installation and operation

- This product must be installed and operated in accordance with the instructions provided. Failure to do so could result in personal injury, damage to your vessel and/or poor product performance.
- Raymarine recommends certified installation by a Raymarine approved installer. A certified installation qualifies for enhanced product warranty benefits. Contact your Raymarine dealer for further details, and refer to the separate warranty document packed with your product.



Warning: Switch off power supply

Ensure the vessel's power supply is switched OFF before starting to install this product. Do NOT connect or disconnect equipment with the power switched on, unless instructed in this document.

FCC



Warning: FCC Warning (Part 15.21)

Changes or modifications to this equipment not expressly approved in writing by Raymarine Incorporated could violate compliance with FCC rules and void the user's authority to operate the equipment.

Compliance Statement (Part 15.19)

This device complies with Part 15 of the FCC Rules. Operation is subject to the following two conditions:

1. This device may not cause harmful interference.
2. This device must accept any interference received, including interference that may cause undesired operation.

FCC Interference Statement (Part 15.105 (b))

This equipment has been tested and found to comply with the limits for a Class B digital device, pursuant to Part 15 of the FCC Rules.

These limits are designed to provide reasonable protection against harmful interference in a residential installation. This equipment generates, uses, and can radiate radio frequency energy and, if not installed and used in accordance with the instructions, may cause harmful interference to radio communications. However, there is no guarantee that interference will not occur in a particular installation. If this equipment does cause harmful interference to radio or television reception, which can be determined by turning the equipment off and on, the user is encouraged to try to correct the interference by one of the following measures:

1. Reorient or relocate the receiving antenna.
2. Increase the separation between the equipment and receiver.
3. Connect the equipment into an outlet on a circuit different from that to which the receiver is connected.
4. Consult the dealer or an experienced radio / TV technician for help.

Innovation, Science and Economic Development Canada (ISED)

This device complies with License-exempt RSS standard(s).

Operation is subject to the following two conditions:

1. This device may not cause interference; and
2. This device must accept any interference, including interference that may cause undesired operation of the device.

This Class B digital apparatus complies with Canadian ICES-003.

Innovation, Sciences et Développement économique Canada (Français)

Cet appareil est conforme aux normes d'exemption de licence RSS.

Son fonctionnement est soumis aux deux conditions suivantes:

1. cet appareil ne doit pas causer d'interférence, et
2. cet appareil doit accepter toute interférence, notamment les interférences qui peuvent affecter son fonctionnement.

Cet appareil numérique de la classe B est conforme à la norme NMB-003 du Canada.



Warning: Maximum Permissible Exposure

For optimal radio performance and minimal human exposure to Radio Frequency (RF) electromagnetic energy, you must ensure that the antenna is:

- connected to the radio before transmitting
- located where it will be away from people
- located at least 1.8 meters (5.9 feet) from the radio's main unit

Failure to observe these guidelines may expose those within the Maximum Permissible Exposure (MPE) radius to RF radiation absorption that exceeds the FCC MPE limit. It is the radio operator's responsibility to ensure that no person comes within this radius.

Water ingress

Water ingress disclaimer

Although the waterproof rating capacity of this product meets the stated water ingress protection standard (refer to the product's *Technical Specification*), water intrusion and subsequent equipment failure may occur if the product is subjected to high-pressure washing. Raymarine will not warrant products subjected to high-pressure washing.

AIS disclaimer

All information presented by the is advisory only, as there is a risk of incomplete and erroneous information. By placing this product into service you acknowledge this and assume complete responsibility for any associated risks, and accordingly release and from any and all claims arising from the use of the AIS service.

Disclaimer

Raymarine does not warrant that this product is error-free or that it is compatible with products manufactured by any person or entity other than Raymarine.

Raymarine is not responsible for damages or injuries caused by your use or inability to use the product, by the interaction of the product with products manufactured by others, or by errors in information utilized by the product supplied by third parties.

Product disposal

Dispose of this product in accordance with the WEEE Directive.

The Waste Electrical and Electronic Equipment (WEEE) Directive requires the recycling of waste electrical and electronic equipment which contains materials, components and substances that may be hazardous and present a risk to human health and the environment when WEEE is not handled correctly.

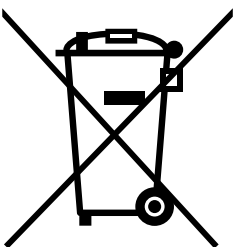

Equipment marked with the crossed-out wheeled bin symbol indicates that the equipment should not be disposed of in unsorted household waste.

Local authorities in many regions have established collection schemes under which residents can dispose of waste electrical and electronic equipment at a recycling center or other collection point.

For more information about suitable collection points for waste electrical and electronic equipment in your region, refer to the Raymarine website: www.raymarine.eu/recycling.



Warranty registration

To register your Raymarine product ownership, please visit www.raymarine.com and register online.

It is important that you register your product to receive full warranty benefits. Your unit package includes a bar code label indicating the serial number of the unit. You will need this serial number when registering your product online. You should retain the label for future reference.

Technical accuracy

To the best of our knowledge, the information in this document was correct at the time it was produced. However, Raymarine cannot accept liability for any inaccuracies or omissions it may contain. In addition, our policy of continuous product improvement may change specifications without notice. As a result, Raymarine cannot accept liability for any differences between the product and this document. Please check the Raymarine website (www.raymarine.com) to ensure you have the most up-to-date version(s) of the documentation for your product.

Chapter 2: Document and product information

Chapter contents

- [2.1 Troubleshooting on page 12](#)
- [2.2 Applicable products on page 12](#)
- [2.3 Compatible Raymarine displays on page 12](#)
- [2.4 Compatible 3rd party displays on page 14](#)
- [2.5 Software updates on page 14](#)

2.1 Troubleshooting

The troubleshooting information provides possible causes and corrective action required for common problems associated with installation and operation of your product.

Before packing and shipping, all Raymarine products are subjected to comprehensive testing and quality assurance programs. If you do experience problems with your product this section will help you to diagnose and correct problems in order to restore normal operation.

If after referring to this section you are still having problems with your product, please refer to the Technical support section of this manual for useful links and Raymarine Product Support contact details.

2.2 Applicable products

This document is applicable to the following products:

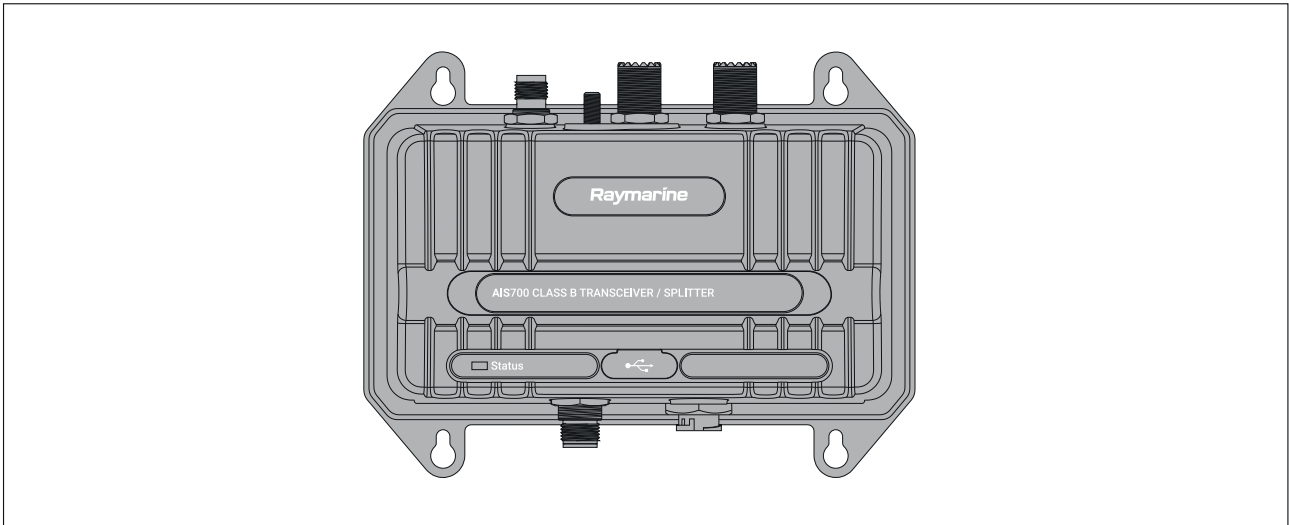

Part number	Description
E70476	The AIS700 is a Class B AIS transceiver with a built-in VHF splitter, used to display real-time information on local vessels, land based stations or aids to navigation that are equipped with either Class A or Class B AIS transceivers.

2.3 Compatible Raymarine displays

The AIS receiver/transceiver is compatible with the MFDs shown below. displays can be connected using either a SeaTalkng® backbone or NMEA 0183 connection set to 38,400 baud rate. Where available it is recommended that the SeaTalkng® / NMEA 2000 connection is used.

Compatible LightHouse™ 3 MFDs

SeaTalkng® is the preferred method of connection to LightHouse™ 3 MFDs, however NMEA 0183 can be used as an alternate connection if required.

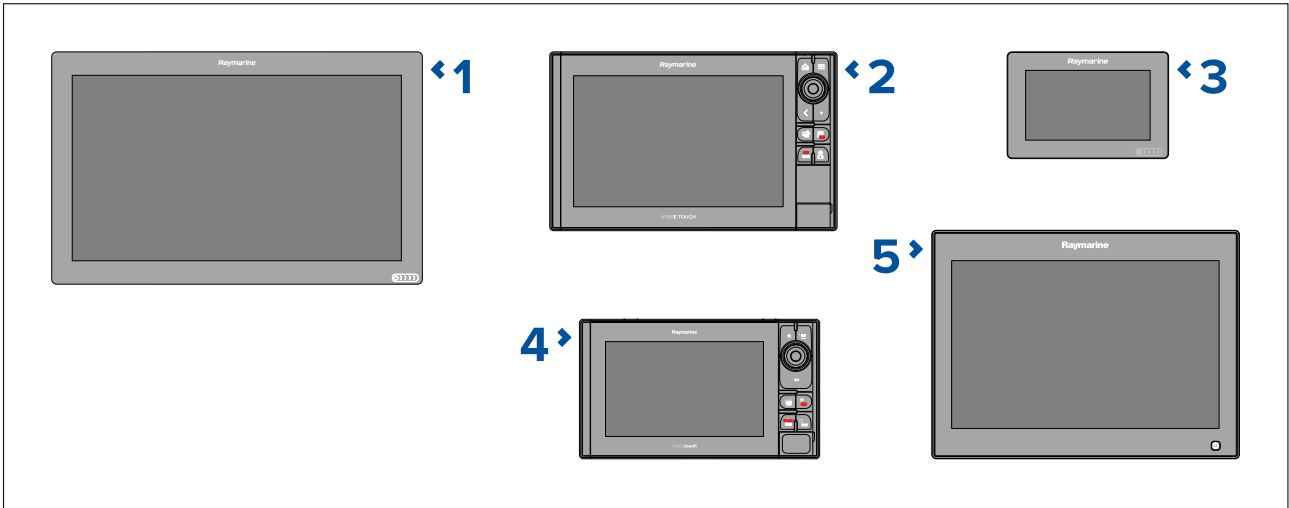

1	Axiom™ XL MFDs
2	Axiom™ Pro MFDs
3	Axiom™ MFDs
4	eS Series MFDs
5	gS Series MFDs

Compatible LightHouse™ 2 MFDs

SeaTalkng® is the preferred method of connection to LightHouse™ 2 MFDs, however NMEA 0183 can be used as an alternate connection if required.

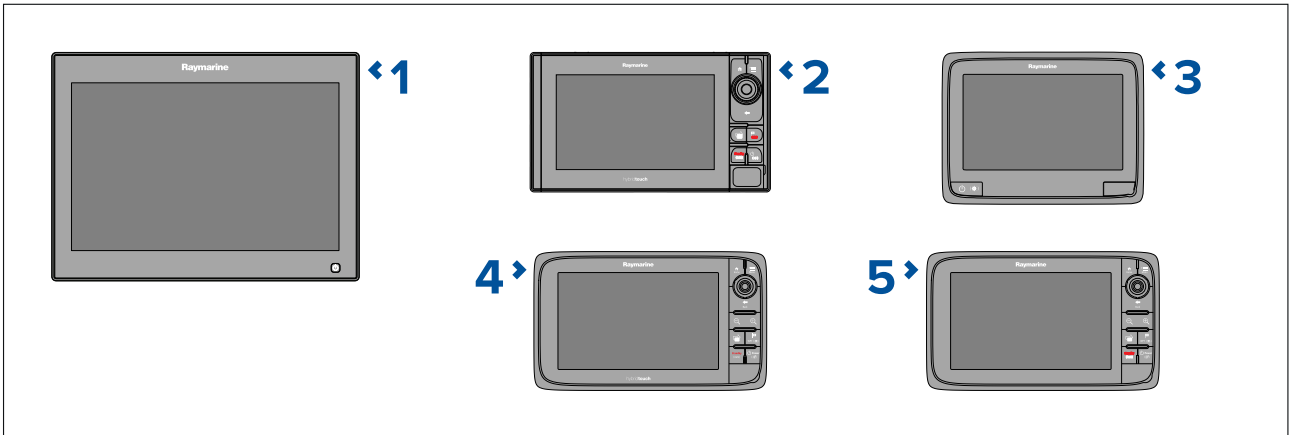

1	gS Series MFDs
2	eS Series MFDs
3	aSeries MFDs
4	eSeries MFDs
5	cSeries MFDs

Compatible instrument displays

Compatible instrument displays can be connected to the same SeaTalkng® network.



1	i70 Instrument display
2	i70s Instrument display

Compatible legacy MFDs

SeaTalkng® is the preferred method of connection for E-Series, C-Series, G-Series and A-Series MFDs, however NMEA 0183 can be used as an alternate connection if required.

E Series Classic and C Series Classic MFDs can only be connected using a NMEA 0183 connection.

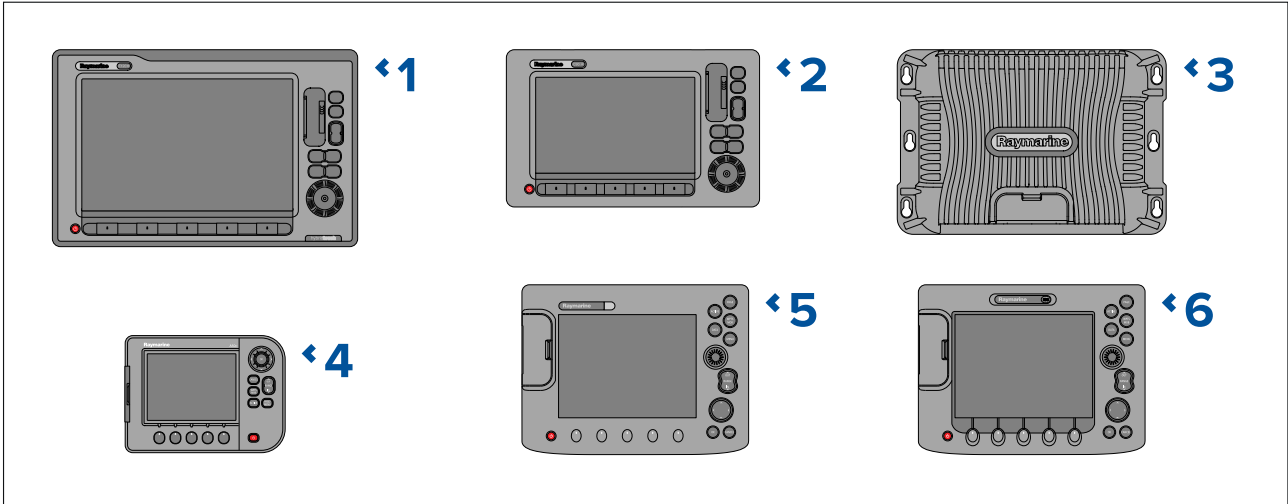

1	E-Series Widescreen MFDs
2	C-Series Widescreen MFDs
3	G-Series systems
4	A-Series MFDs
5	C Series Classic MFDs (Connection via NMEA 0183 only)
6	E Series Classic MFDs (Connection via NMEA 0183 only)

2.4 Compatible 3rd party displays

The AIS receiver/transceiver can be connected to displays manufactured by 3rd parties.

3rd party displays can be connected using either a NMEA 2000 or a NMEA 0183 connection set to 38,400 baud rate. Where available it is recommended that a NMEA 2000 connection is used where possible.

Note:

The data available to 3rd party displays will be limited to the NMEA 2000 PGNs and NMEA 1083 sentences that are supported by both the AIS receiver/transceiver and the 3rd party display.

2.5 Software updates

Raymarine periodically releases software updates for its products. These updates can provide new and enhanced features and also improve product performance and usability. You should ensure that you have the latest software for your products by regularly checking the website for new software. The software update process requires a compatible MFD powered by LightHouse™ 2 release 13 or greater, or LightHouse™ 3.

Check the Raymarine website regularly for software updates for your products:
www.raymarine.com/software.

The MFD used to perform the software update must be the designated Data master and be connected via SeaTalkng® / NMEA 2000 to the product being updated.

Please refer to Raymarine website for instructions on how to use your MFD to perform a software update: www.raymarine.com/software

If in doubt as to the correct procedure for updating your product software, refer to your dealer or Raymarine technical support.

Caution: Installing software updates

- The software update process is carried out at your own risk. Before initiating the update process ensure you have backed up any important files.
- Ensure that the unit has a reliable power supply and that the update process is not interrupted.
- Damage caused by an incomplete update is not covered by Raymarine warranty.
- By downloading the software update package, you agree to these terms.

Chapter 3: Troubleshooting

Chapter contents

- [3.1 Power up troubleshooting on page 18](#)
- [3.2 AIS data troubleshooting on page 18](#)
- [3.3 VSWR Alarm troubleshooting on page 22](#)
- [3.4 Data conflicts and data loops on page 22](#)
- [3.5 LED Status indicator on page 22](#)

3.1 Power up troubleshooting

Problems at power up and their possible causes and solutions are described here.

Product does not turn on or keeps turning off

Possible causes	Possible solutions
Blown fuse / tripped breaker	<ol style="list-style-type: none"> 1. Check the condition of fitted fuses and breakers and connections, replace if necessary. 2. Ensure fitted fuse rating is correct (3 A) 3. If fuse keeps blowing check for cable damage, broken connector pins or incorrect wiring.
Poor / damaged / insecure power supply cable / connections	<ol style="list-style-type: none"> 1. Check that the power cable connector is fully inserted into the product and locked in position. 2. Check the power supply cable and connectors for signs of damage or corrosion, replace if necessary. 3. With the product powered on, try flexing the power cable near to the product connector to see if this causes the product to re-boot/lose power, replace if necessary. 4. Check the product's power supply voltage, the condition of the battery terminals and power supply cables, ensuring connections are secure, clean and free from corrosion, replace if necessary. 5. With the product powered on and where applicable, transmitting, using a multi-meter, check for a voltage drop across all connectors /fuses etc, and replace if necessary.
Incorrect power connection	The power supply may be wired incorrectly, ensure the installation instructions have been followed.
Power source insufficient	Check that your power supply (battery or distribution panel) is providing a minimum of 10.2 V to the product.

Product will not boot up (re-boot loop)

Possible causes	Possible solutions
Power supply and connection	See possible solutions from 'Products does not turn on or keeps turning off' above.
Software corruption	In the unlikely event that the product's software has become corrupted, please try re-flashing the product with the latest software from the Raymarine website: www.raymarine.com/software

3.2 AIS data troubleshooting

No AIS targets shown on the display

Possible causes	Possible solutions
Data / network problem	Review and carry out solutions in the <i>Missing, conflicting or erratic data</i> table below.
VHF antenna fault	Check the VHF antenna is properly connected and is not short circuiting to the vessel structure.
GNSS (GPS) antenna fault	Check the GNSS (GPS) antenna is properly connected and is installed in an appropriate location (e.g.: clear view of the sky).
AIS feature not enabled on display	Refer to the Operation instructions for your display to identify how to enable the AIS feature.

Possible causes	Possible solutions
MFD set to display Dangerous or Buddy targets only and none are in range of your vessel.	Refer to the Operation instructions for your display to identify how to enable the display of all AIS targets.
No AIS equipped vessels in range.	Wait for more vessels to be in your vicinity and check again (e.g.: in a marina).

Missing, conflicting or erratic data

Possible causes	Possible solutions
MMSI number and / or static data not configured.	Configure the product with an MMSI number and correct static data using the proAIS2 software and a PC. Refer to Configuration for details.
AIS configuration, static data is not being saved.	Disconnect all connections then connect only the USB cable to a PC and retry configuration.
AIS hardware not detected by display	<ul style="list-style-type: none"> • Check all connections are secure and free from damage; replace if required. • When connected using NMEA 0183, ensure the port used to connect the product to your MFD is set to 38,400 baud rate. Also check that the port is configured to output AIS data (usually Port 1 outputs AIS data by default). • Ensure the MFD is connected to the same SeaTalkng® / NMEA 2000 network as your display, or that the MFD is connected directly to the relevant NMEA 0183 connections.
SeaTalkng® / NMEA 2000 and NMEA 0183 connected at the same time	Ensure only one connection is made, either SeaTalkng® / NMEA 2000 OR NMEA 0183.
Multiple AIS receivers/transceivers connected and operating	If your system includes more than one AIS receiver/transceiver, ensure that only one is powered on or transmitting.

Configuration

The AIS700 should be configured prior to installation using a PC/laptop, USB Micro-B cable, and the supplied proAIS2 software.

The manner in which configuration is carried out depends on the legal requirements of your geographical location.

USA

In the USA, it is a legal requirement that the configuration is performed by a qualified dealer or installer.

You can use the supplied proAIS2 PC software, to check the vessel data programmed into your AIS700. If this information is incorrect please contact your Raymarine dealer.

Areas outside of USA

In areas outside of the USA, use the supplied proAIS2 PC software to configure your AIS700.

Note: If configuring after installation ensure any MFDs on the same network are switched off first, otherwise you will not be able to correctly configure your AIS700.

The following vessel-related static data should be configured:

- MMSI number
- Vessel name
- Vessel call sign
- Vessel dimensions including AIS GNSS (GPS) antenna location
- Vessel type

A valid 9 digit MMSI number must be entered. Invalid numbers will not be accepted. Only the *Vessel call sign* field is entirely optional.

Obtain MMSI (Maritime Mobile Service Identity) number

Before commencing installation ensure you have obtained an MMSI number for your vessel.

An MMSI is a 9 digit number which is sent over a radio frequency channel in order to identify the originating vessel/station. If your vessel already has an MMSI number (used for a VHF DSC radio) then the same MMSI number must be used to program your product.

Note:

If an MMSI number is not entered, the DSC functionality of your radio will be disabled.

In the United States of America, the MMSI and Static Data must be entered only by a Raymarine® dealer or other appropriately qualified installer of marine communications equipment on board vessels.

The user is NOT authorized to do this.

In some areas, a radio operator licence is required before an MMSI number will be issued. You can request an MMSI number from same agency that issues radio or Ship Radio licences in your area.

In Europe and other parts of the world outside of the United States of America, the MMSI and Static data can be set up by the user.

For further details, refer to the relevant Telecommunications Regulatory Body for your area.

Refer to [Appendix A MMSI Regulatory bodies and application submissions](#) for a list of contacts for obtaining MMSI numbers for some areas.

Installing proAIS2 and USB drivers

Before connecting the AIS unit to a PC/laptop, the proAIS2 application and USB drivers must be installed. To install follow the steps below:

1. Download the ProAIS2 software from the Raymarine website: www.raymarine.com/software
2. Double click on the *setup.exe* file to launch the installer.
3. Follow the on screen installation instructions, ensuring that the option to install USB drivers is selected when presented.
4. Once installed the AIS unit can be connected to the PC/laptop. The USB drivers will be installed automatically and the AIS unit will appear as a new COM port device.
5. Launch proAIS2 by navigating to the proAIS2 folder accessible from the start menu.

Configuring using proAIS2

Important:

In the United States of America, it is a violation of the rules of the Federal Communications Commission to input an MMSI that has not been properly assigned to the end user or to otherwise input any inaccurate data in this device. The MMSI and Static Data must be entered only by a Raymarine dealer or other appropriately qualified installer of marine communications equipment on board vessels.

Ensure you check the regulations for your location to ensure you are allowed to configure MMSI data on your unit.

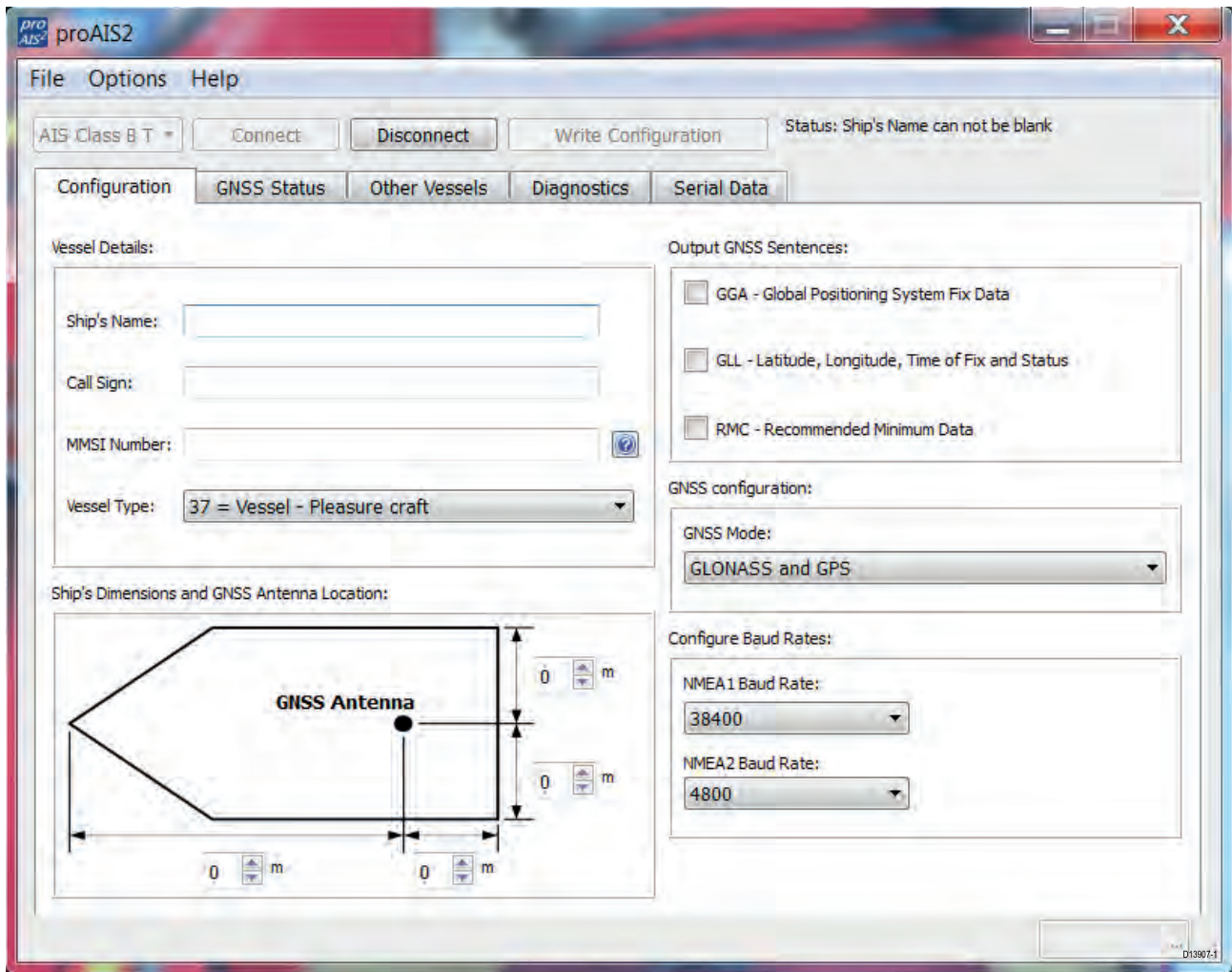

With the proAIS2 software open on your PC:

1. Select the AIS device from the drop down list at the top of the page.
2. Click **Connect**.
3. Enter your vessel's details, including MMSI in the relevant fields.
4. Select a **Vessel Type** appropriate for your vessel from the drop down list.
5. Ensure that the built-in GNSS receiver is not outputting sentences (i.e. ensure GGA, GLL and RMC boxes are not ticked).

The GNSS receiver built-in to the AIS700 is intended to provide GNSS data to the AIS unit only, outputting this data can cause data conflicts. The ability to output these sentences is intended for diagnostics purposes only.

6. Enter your vessel's dimensions and GNSS (GPS) antenna location in the relevant fields.
7. If required set the baud rate for your NMEA 0183 ports.
8. Click **Write Configuration** to save your configuration settings.
9. Click **Disconnect**.

VHF antenna specification

It is important to ensure that you use a VHF antenna that meets the requirements below.

Antenna type:	Wideband
Connector type:	PL-259
Impedance	50 Ω
Frequency range:	156 MHz to 162 MHz
VSWR ratio:	2:1 maximum, across the entire frequency range
Gain:	3 dBi Max

3.3 VSWR Alarm troubleshooting

If you experience regular VSWR alarms try the troubleshooting guidance below.

Possible causes	Possible solutions
Incorrect antenna in use.	Check that your antenna meets the required VHF antenna specification that can be found in the product documentation.
Antenna short or open circuit.	Check antenna for short or open circuit, repair or replace as necessary.
Product running an older version of software	Software version 1.09 included Improvements to Antenna fault detection (VSWR alarm).





3.4 Data conflicts and data loops

To avoid potential data conflicts and data loops products should not be connected to the same device using more than 1 network protocol.

Important:
<ul style="list-style-type: none"> Do NOT connect to an MFD of VHF radio using NMEA 0183 and SeaTalkng® / NMEA 2000 connections at the same time. Do NOT connect to a PC using NMEA 0183 and USB connections at the same time. If you are connecting to an VHF Radio that has built-in AIS you must disable the VHF Radio's AIS function first. Refer to your Radio's documentation for details on disabling the AIS function.

3.5 LED Status indicator

The LED status indicator on the transceiver provides an indication of product status.

LED	Color	Status
	Green	Transceiver is powered up and operating normally.
	Amber	Transceiver is not transmitting. <ul style="list-style-type: none"> Wait at least 30 minutes to check that a 'Quiet time' has not been requested by the local authority.
	Red	Transceiver fault / MMSI number not programmed. <ul style="list-style-type: none"> Check MMSI number and static data has been correctly configured. Check GNSS antenna is properly connected and has a clear unobstructed view of the sky. Check the VHF antenna is properly connected and is not short circuiting to the vessel structure. Check that power supply is at the correct voltage (12 V dc or 24 V dc). Excessive difference between Heading from an input device, and COG.
	Blue	Transceiver is running in silent mode (not transmitting). To disable silent mode: <ul style="list-style-type: none"> Check the AIS Silent mode setting on your MFD. Check the position of the dedicated Silent mode switch, if fitted (the switch will override the MFD setting).

LED	Color	Status
		<ul style="list-style-type: none">• Where no dedicated switch is fitted, check that the Light Green and Orange wires on the power/data cable are not shorting together.

Chapter 4: Technical support

Chapter contents

- 4.1 Product returns process on page 26
- 4.2 Raymarine product support and servicing on page 26

4.1 Product returns process

Prior to initiating the product return process please ensure that you have completed the actions below:

1. Check all connections and power supply.
2. Programmed the AIS receiver/transceiver with an MMSI and configured static data using the supplied proAIS2 software.
3. Check that your display is compatible with your AIS receiver/transceiver.
4. Ensure that your display software is up to date.
5. Ensure that the VHF and GNSS (GPS) antennas are operating correctly and installed in accordance with the instructions provided.
6. Ensure that the VHF antenna's specification meets the requirements for your AIS receiver/transceiver.
7. Check the LED status indicator against the diagnostics section of the product manual.
8. Connect the AIS receiver/transceiver to a PC and check the proAIS2 diagnostics page for faults.
9. Read the product manual and troubleshooting information.
10. If the above actions do not resolve your problems, please call Raymarine Service and Support to obtain a Warranty Ref. No., see product return detail on the Raymarine website:

Note:

The above actions need to be completed prior to Raymarine accepting the unit back under warranty.

4.2 Raymarine product support and servicing

Raymarine provides a comprehensive product support service, as well as warranty, service, and repairs. You can access these services through the Raymarine website, telephone, and e-mail.

Product information

If you need to request service or support, please have the following information to hand:

- Product name.
- Product identity.
- Serial number.
- Software application version.
- System diagrams.

You can obtain this product information using diagnostic pages of the connected MFD.

Servicing and warranty

Raymarine offers dedicated service departments for warranty, service, and repairs.

Don't forget to visit the Raymarine website to register your product for extended warranty benefits: <http://www.raymarine.co.uk/display/?id=788>.

Region	Contact
United Kingdom (UK), EMEA, and Asia Pacific	<ul style="list-style-type: none">• E-Mail: emea.service@raymarine.com• Tel: +44 (0)1329 246 932
United States (US)	<ul style="list-style-type: none">• E-Mail: rm-usrepair@flir.com• Tel: +1 (603) 324 7900

Web support

Please visit the "Support" area of the Raymarine website for:

- **Manuals and Documents** — <http://www.raymarine.com/manuals>
- **Technical support forum** — <http://forum.raymarine.com>
- **Software updates** — <http://www.raymarine.com/software>

Worldwide support

Region	Contact
United Kingdom (UK), EMEA, and Asia Pacific	<ul style="list-style-type: none">• E-Mail: support.uk@raymarine.com• Tel: +44 (0)1329 246 777
United States (US)	<ul style="list-style-type: none">• E-Mail: support@raymarine.com• Tel: +1 (603) 324 7900 (Toll-free: +800 539 5539)
Australia and New Zealand (Raymarine subsidiary)	<ul style="list-style-type: none">• E-Mail: aus.support@raymarine.com• Tel: +61 2 8977 0300
France (Raymarine subsidiary)	<ul style="list-style-type: none">• E-Mail: support.fr@raymarine.com• Tel: +33 (0)1 46 49 72 30
Germany (Raymarine subsidiary)	<ul style="list-style-type: none">• E-Mail: support.de@raymarine.com• Tel: +49 (0)40 237 808 0
Italy (Raymarine subsidiary)	<ul style="list-style-type: none">• E-Mail: support.it@raymarine.com• Tel: +39 02 9945 1001
Spain (Authorized Raymarine distributor)	<ul style="list-style-type: none">• E-Mail: sat@azimut.es• Tel: +34 96 2965 102
Netherlands (Raymarine subsidiary)	<ul style="list-style-type: none">• E-Mail: support.nl@raymarine.com• Tel: +31 (0)26 3614 905
Sweden (Raymarine subsidiary)	<ul style="list-style-type: none">• E-Mail: support.se@raymarine.com• Tel: +46 (0)317 633 670
Finland (Raymarine subsidiary)	<ul style="list-style-type: none">• E-Mail: support.fi@raymarine.com• Tel: +358 (0)207 619 937
Norway (Raymarine subsidiary)	<ul style="list-style-type: none">• E-Mail: support.no@raymarine.com• Tel: +47 692 64 600
Denmark (Raymarine subsidiary)	<ul style="list-style-type: none">• E-Mail: support.dk@raymarine.com• Tel: +45 437 164 64
Russia (Authorized Raymarine distributor)	<ul style="list-style-type: none">• E-Mail: info@mikstmarine.ru• Tel: +7 495 788 0508

Appendix A MMSI Regulatory bodies and application submissions

Country	Regulatory Body	Website links
UK	Ofcom	http://www.ofcom.org.uk
USA	FCC (www.fcc.gov)	<ul style="list-style-type: none"> • www.boatus.com • www.seatow.com • www.usps4mmsi.com
Canada	Industry Canada	www.ic.gc.ca
Australia	Australian Maritime Safety Authority (AMSA)	http://www.amsa.gov.au/mmsi/
Holland	Agentschap Telecom	www.agentschaptelecom.nl
Belgium	Belgisch Instituut voor Postdiensten en Telecommunicatie	www.bipt.be
Germany	Bundesnetzagentur	https://www.bundesnetzagentur.de/DE/Sachgebiete/Telekommunikation/Unternehmen_Institutionen/Frequenzen/SpezielleAnwendungen/Seefunk/Seefunk-node.html
Denmark	søfartsstyrelsen	www.soefartsstyrelsen.dk
France	Agence Nationale Des Fréquences	https://www.anfr.fr/licences-et-autorisations/radiomaritime/
Italy	Ministero dello sviluppo economico - Direzione generale per le attività territoriali	http://www.sviluppoeconomico.gov.it/images/stories/documenti/mmsinew.pdf
Spain	Ministero De Fomento	https://www.fomento.gob.es/MFOM/LANG_CASTELLANO/DIRECCIONES_GENERALES/MARINA_MERCANTE/RADIOCOMUNICACIONES/MMSI/
Sweden	PTS	www.pts.se
Finland	Viestintävirasto	https://www.viestintavirasto.fi/en/spectrum/radiolicesces/Boatingandnavigation.html
Iceland	Post and telecom administration in Iceland	www.pfs.is
New Zealand	Radio Spectrum Management	https://www.rsm.govt.nz/licensing/radio-operator-certificates-and-callsigns?searchterm=MMSI
Chile	Directemar	www.nauticentro.cl
Panama	Autoridad Maritima de Panama	www.amp.gob.pa/newside/spanish/puertos2/de-pima/ima.html

Index

A

Applicable products 12

C

Compatible instrument displays13

Compatible legacy MFDs14

Compatible MFDs..... 12

Configuration..... 21

Contact details.....26

D

Diagnostics.....22

L

LED Status22

LightHouse™ 213

LightHouse™ 3 12

M

MMSI..... 20

Where to apply29

P

proAIS2 21

Product recycling (WEEE) 9

Product returns process26

Product support.....26

S

Service Center.....26

Software updates 15

T

Technical support.....26

Troubleshooting 12

Power..... 18

W

Warranty26

WEEE Directive.....9



Raymarine

Marine House, Cartwright Drive, Fareham, Hampshire.
PO15 5RJ. United Kingdom.

Tel: +44 (0)1329 246 700

www.raymarine.com

Raymarine®

a brand by  **FLIR®**