



LIGHTHOUSE 4

MULTIFUNCTION DISPLAY OPERATING SYSTEM v4.6.103

OPERATION INSTRUCTIONS

English (en-US)
Date: 03-2024
Document number: 81406 (Rev 12)
© 2024 Raymarine UK Limited

Raymarine®

Legal notices

Trademark and patents notice

Raymarine, Tacktick, Pathfinder, ClearPulse, Truzoom, SeaTalk, SeaTalk^{hs}, SeaTalkng, and **Micronet**, are registered or claimed trademarks of Raymarine Belgium.

FLIR, Fishidy, Fishing Hot Spots, YachtSense, DockSense, LightHouse, RangeFusion, DownVision, SideVision, RealVision, HyperVision, Dragonfly, Element, Quantum, Axiom, Instalert, Infrared Everywhere, The World's Sixth Sense and **ClearCruise** are registered or claimed trademarks of FLIR Systems, Inc.

All other trademarks, trade names, or company names referenced herein are used for identification only and are the property of their respective owners.

This product is protected by patents, design patents, patents pending, or design patents pending.

Fair Use Statement

You may print no more than three copies of this manual for your own use. You may not make any further copies or distribute or use the manual in any other way including without limitation exploiting the manual commercially or giving or selling copies to third parties.

Content notice

Please ensure that you have obtained this document only from Raymarine®, and that it is the **latest** available version.

There are numerous third-party Internet websites (such as *www.manualslib.com*) hosting Raymarine product manuals. These websites are not authorized by Raymarine® to do so, and are often hosting illegitimate or older versions of Raymarine product manuals, which may contain inaccurate or misleading information.

To obtain the latest official documentation for a Raymarine® product, please visit the official Raymarine® website: www.raymarine.com/manuals

CONTENTS

CHAPTER 1 IMPORTANT INFORMATION.....	23
Safety warnings	23
Product warnings.....	24
Electronic chart data.....	24
Regulatory notices.....	25
Disclaimer.....	25
End-User License Agreements (EULAs).....	25
Open source license agreements.....	25
Regulatory approvals	25
Warranty registration	25
IMO and SOLAS.....	26
Technical accuracy.....	26
Publication copyright	26
CHAPTER 2 DOCUMENT INFORMATION.....	27
2.1 Product documentation	28
User manuals Print Shop	28
2.2 Document conventions.....	28
2.3 Document illustrations and screenshots	29
2.4 Glossary.....	29
CHAPTER 3 SOFTWARE DETAILS	30
3.1 Applicable software version	31
3.2 LightHouse MFD software compatibility.....	31
3.3 Compatible displays.....	31
3.4 New software features.....	32
Spotify app removal.....	33
3.5 Compatible peripheral product software	33
3.6 YachtSense Link network connection.....	34
3.7 Legacy eS and gS Series compatibility with Axiom displays	34
3.8 Software updates.....	35
Checking current software	36
Updating software from a memory card.....	36
Updating software over the internet.....	37
CHAPTER 4 GENERAL INFORMATION	38
4.1 Memory card compatibility.....	39
Removing MicroSD card from its adaptor	39
Inserting a MicroSD card — Axiom® and Axiom®+ displays.....	40
Inserting a MicroSD card — Axiom® 2 Pro displays	40
Inserting a MicroSD card — Axiom® Pro displays	41
Inserting memory card into external storage devices.....	41
4.2 Applications and integrations.....	42
4.3 Menu types.....	43
4.4 Setting controls	44
4.5 Alarm and information notifications	45
4.6 Sidebar.....	46
Sidebar selector.....	46

Customizing data sidebars.....	48
4.7 Alpha Series sidebar operations (LightHouse™ 4 MFD).....	48
Alpha Series network operations (LightHouse™ 4 MFD).....	49
4.8 Data overlays.....	49
Adding a data overlay.....	50
4.9 Display data	50
Battery data	50
Boat data	51
Depth data.....	51
Display data	51
Distance data	51
Engine data.....	51
Fuel data.....	52
Environment data	52
Inside environment data	53
GPS data	53
Heading data	53
Navigation data	53
Pilot data.....	54
Speed data.....	54
Time data.....	54
Wind data	54
Tank level data	55
Generator data.....	55

Load cell data	56
4.10 Sonar depth data recording/logging.....	56
CHAPTER 5 GETTING STARTED	57
5.1 Switch on / off.....	58
Axiom® and Axiom® 2 displays with a power swipe	58
Axiom® and Axiom® 2 displays with a power button	58
5.2 Controls.....	59
Axiom®, Axiom® +, Axiom® XL and Axiom® 2 XL controls.....	59
Axiom® 2 Pro controls	59
Axiom® Pro controls.....	60
RMK controls	61
iKey Bluetooth keyboard controls.....	62
5.3 Initial setup	63
First power up.....	63
First power up datamaster selection.....	63
Startup wizard	64
Axiom® 2 Pro keypad type selection.....	65
Safety clearances.....	65
First power up limitation on use acknowledgement	68
Engine manufacturer selection	68
Multiple data sources (MDS)	68
Battery configuration.....	69

Assigning a function to the User Configurable key.....	70
Performing a settings reset.....	70
Performing a factory reset.....	70
Importing user data.....	70
5.4 Calibration.....	71
Calibration sources.....	71
Sonar transducer calibration.....	71
RealVision™ AHRS calibration.....	72
Transducer calibration (iTC-5).....	73
STW calibration (DST810).....	75
RSW series wind transducer configuration.....	77
5.5 Shortcuts menu.....	79
Taking a screenshot.....	79
Activating touchlock.....	80
Radar standby.....	80
Eject SD card.....	80
Enabling/Disabling sonar modules.....	80
Autopilot shortcuts.....	80
Audio volume control.....	80
Adjusting brightness.....	81
Auto brightness.....	81
Display mode.....	82
5.6 Device pairing.....	82
Pairing a RMK remote keypad.....	82
Pairing with a Quantum Radar scanner.....	82

Pairing a Bluetooth speaker.....	83
5.7 Networking constraints.....	83
5.8 Internet connection.....	84
YachtSense Link network connection.....	84
Connecting to the internet using Wi-Fi.....	84
Wi-Fi settings — Axiom displays.....	85
Wi-Fi settings — Axiom 2 displays.....	85

CHAPTER 6 HOMESCREEN..... 87

6.1 Accepting the Limitations on Use.....	88
6.2 Homescreen overview.....	88
6.3 Homescreen app page icons.....	89
6.4 MFD Apps.....	89
Chart app.....	90
Radar app.....	90
Fishfinder app.....	91
Dashboard and Engine apps.....	92
Entertainment apps.....	93
YachtSense and DockSense apps.....	94
Other apps.....	94
6.5 Creating an app page.....	95
Additional mode icon steps.....	95
Customizing an existing app page.....	95
Editing the splitscreen ratio.....	96
6.6 Homescreen Dynamic tile.....	96
Enabling and configuring the Dynamic tile.....	97
6.7 Global positioning.....	97

Global Navigation Satellite System (GNSS)		
constellations.....	97	
Satellite based augmentation systems		
(SBAS)	98	
GNSS (GPS) Status	99	
GNSS settings.....	99	
GNSS constellation selection compatible		
receivers	101	
6.8 Status area	102	
Status area icons.....	103	
6.9 My data	104	
Fuel/trip manager	104	
Files	106	
Import/export	106	
6.10 My profiles	108	
Demo profiles	109	
CHAPTER 7 SETTINGS	110	
7.1 Homescreen settings menus	111	
7.2 Selecting display language	112	
Languages	112	
7.3 Boat details	112	
7.4 Battery configuration.....	114	
7.5 Generator configuration	114	
7.6 Tanks	115	
7.7 Calibrating tanks	116	
Run wizard calibration.....	116	
Import calibration.....	117	
7.8 Setting fuel tanks as not for propulsion.....	117	
7.9 Units settings menu	118	
7.10 Splashscreen and background images	119	
Screen resolutions	119	
Customizing the splashscreen	120	
Customizing the homescreen back-		
ground	120	
7.11 Shared Brightness	121	
Setting up shared brightness.....	121	
7.12 Datamaster.....	122	
Switching datamaster	122	
7.13 Switching off sensor LEDs	122	
7.14 Find me	123	
7.15 IP device user interface access	123	
7.16 Connecting to a wireless display	124	
Disconnecting a wireless display.....	124	
Unpairing a wireless display	125	
7.17 NMEA 0183 settings	125	
NMEA 0183 settings.....	125	
CHAPTER 8 ALARMS MANAGER	126	
8.1 Alarms manager.....	127	
8.2 Active alarm indication	128	
8.3 Alarm settings.....	128	
8.4 External alarm speaker / buzzer	130	
8.5 Acknowledging alarms	130	
8.6 YachtSense Link router alarms	130	

8.7 Digital switching alarms	131	9.7 Rudder damping levels and deadband angles.....	146
8.8 Man Overboard (MOB).....	131	Adjusting the Rudder Damping level	146
MOB mode	132	CHAPTER 10 TROLLING MOTOR CONTROL	147
8.9 DSC distress notification.....	132	10.1 Trolling motor integration	148
8.10 High Speed Alarm	132	10.2 Trolling motor control overview	148
CHAPTER 9 AUTOPILOT INTEGRATION	134	10.3 Manual control.....	150
9.1 Commissioning - Evolution autopilot system.....	135	10.4 Anchor mode	150
Commissioning pre-requisites.....	135	10.5 Hold heading.....	151
Commissioning steps	135	10.6 Navigation mode.....	152
Vessel hull type selection	135	10.7 Alarms and limits	153
Using the Dockside wizard.....	135	CHAPTER 11 WAYPOINTS, ROUTES AND TRACKS	154
Compass linearization — Evolution autopilots	138	11.1 Waypoints	155
Compass lock.....	140	Placing a waypoint using chart context menu.....	155
9.2 Autopilot control	140	Placing a waypoint at a specific latitude and longitude	155
Engaging the autopilot — Locked heading	141	Placing a waypoint at your vessel's location.....	156
Engaging the autopilot — Navigation	141	Waypoint management.....	156
Engaging and disengaging the autopilot - physical buttons	141	Waypoint symbols	158
Disengaging the autopilot.....	141	11.2 Routes	159
9.3 Pilot sidebar	142	Creating a Route	159
9.4 Pilot Version keypad LED status (Axiom® 2 Pro only).....	143	Route waypoint spacing.....	159
9.5 Pilot pop-up	143	Route highlighting.....	160
9.6 Autopilot Control — Pilot set-up menu	143	Autoroute	161

Importing a route	162	Creating a trackline search (non-return)	
Route management	163	pattern	177
11.3 Tracks	164	12.7 Polygon search pattern	178
Creating a track	164	Creating a polygon search pattern	178
Converting a track to a route	165	12.8 SAR pattern broadcast and receipt	179
Track management	165	Hiding original SAR pattern	180
11.4 Sharing Waypoints, Routes and Tracks	165	12.9 Un-managed searches	180
11.5 Waypoint, routes and tracks capacity	166	Broadcasting an un-managed SAR	
CHAPTER 12 SAR (SEARCH AND RESCUE)		pattern	180
PATTERNS	167	SAR pattern receipt (un-managed / not	
12.1 SAR (Search and Rescue) patterns	168	assigned as SRU)	181
12.2 Sector search pattern	168	12.10 Managed searches	182
Creating a sector search pattern	169	SMC action — Broadcasting a SAR	
Drift effects on sector search patterns	170	pattern	182
12.3 Expanding square search pattern	171	SMC action — Instructing SRU to divert	182
Creating an expanding square search		SMC action — Instructing SRU to	
pattern	171	resume	183
Drift effects on expanding square search		SRU SAR pattern receipt notification	
patterns	173	overview	184
12.4 Creeping line / Parallel line search		SRU action — Accepting a SAR pattern	185
pattern	173	SRU search controls	185
Creating a Creeping line / Parallel line search		SRU action — Diverting from a SAR	
pattern	174	pattern	186
12.5 Trackline search (return) pattern	175	SRU divert as instructed — overview	186
Creating a trackline search (return)		SRU action — Diverting as instructed by	
pattern	176	SMC	187
12.6 Trackline search (non-return) pattern	176		

SRU action — Resuming from SMC		
instructed point.....	188	
12.11 Searches lists	188	
SMC searches list	189	
Search history	189	
CHAPTER 13 CHART APP - GENERAL	190	
13.1 Chart app chapters.....	191	
13.2 Chart app overview	191	
Chart app onscreen controls	192	
Chart app simulator	192	
Chart ranging and panning	193	
Quick adjust menu	193	
Context menu	194	
AIS target context menu	194	
Radar target context menu	195	
Selecting cartography.....	195	
Chart modes	196	
Vessel icon	197	
Chart motion mode	197	
Chart orientation	198	
Vessel details	199	
Fuel range	200	
Charted objects.....	201	
Chart layers	201	
Camera tracking	202	
13.3 Cartography overview	202	
Supported cartography vendors	203	
End-User License Agreements (EULAs).....	203	
13.4 LightHouse charts	203	
LightHouse Chart Store	204	
Pre-loaded LightHouse Chart Cards	204	
Hybrid LightHouse charts	205	
Redeeming chart voucher	205	
Downloading charts from My Charts	205	
13.5 S-63 Encrypted Charts.....	206	
S-63 Encrypted Charts installation		
process	206	
Obtaining an S-63 MFD activation file.....	207	
Copying user permit file(s) to memory		
card	208	
Purchasing S-63 Encrypted Charts.....	208	
Installing base cells and cell permits	208	
Installing cumulative updates	209	
S-63 Encrypted Chart settings	210	
13.6 Navigation	210	
Cross Track Error (XTE)	211	
Navigating to a waypoint or point of interest		
(manual steering)	211	
Navigating to a waypoint or point of interest		
(autopilot)	212	
Following a Route (manual steering).....	212	
Following a Route (autopilot).....	214	

Automatic turning	215	13.16 Chart settings menu.....	243
Following a Route using automatic turning	216	Cartography settings menu.....	243
13.7 Rudder bar indicator	218	Layers settings menu	244
13.8 Depths and contours.....	218	Depth settings menu.....	247
Depth soundings.....	218	View & motion settings menu	249
Depth contours.....	219	Advanced settings menu	250
RealBathy™ depth contours.....	221	Page settings menu	251
SonarChart™ Live.....	222	CHAPTER 14 CHART APP - NAVIGATE MODE	252
13.9 Target tracking.....	223	14.1 Navigate mode	253
AIS target tracking.....	223	14.2 Navigate mode main menu	253
Radar target tracking	228	14.3 Navigate mode settings menus.....	253
13.10 Collision avoidance	230	CHAPTER 15 CHART APP - FISHING CHART MODE.....	254
Dangerous targets alarm	231	15.1 Fishing chart mode.....	255
Predicted areas of danger.....	231	15.2 Fishing chart mode main menu.....	255
Obstruction alarm (legacy LightHouse charts)	236	15.3 Fishing intel menu	255
LightHouse charts dangerous objects	238	Sea surface temperature menu	256
13.11 Target intercept.....	238	15.4 SiriusXM layer options.....	256
13.12 Reeds almanac	239	15.5 Fishing chart mode settings menus	256
13.13 Find nearest.....	239	CHAPTER 16 CHART APP - FISH MAPPING MODE.....	257
13.14 Measure	241	16.1 Fish mapping mode	258
Measuring vessel to point.....	241	Activating your SiriusXM receiver.....	258
Measuring point to point	241	16.2 Fish mapping mode main menu.....	259
Deleting rulers	242	16.3 Fishing recommendations	259
13.15 ClearCruise™ Augmented Reality	242	16.4 Fish mapping layers.....	260
Field of View	242	16.5 Layer / fish type identification	260

16.6	Limiting data display limits.....	261	18.3	Using animation controls	277
16.7	Fish mapping subscription.....	261	18.4	Setting a specific date for animations.....	277
16.8	Fish mapping mode settings menus	261	18.5	Tide station information.....	277
CHAPTER 17 CHART APP - WEATHER MODE		262	18.6	LightHouse charts dynamic tide graphic.....	278
17.1	Weather mode.....	263	18.7	Navionics dynamic tide graphic	278
	Weather mode context menu	263	18.8	Current station information.....	278
17.2	Weather mode main menu	263	18.9	LightHouse Charts dynamic current graphic.....	279
17.3	Activating your SiriusXM receiver.....	264	18.10	C-Map dynamic current graphic.....	279
	SR200 diagnostics mode	264	18.11	Navionics dynamic current graphic	279
17.4	Weather layers	264	18.12	Displaying tide or current graphs.....	280
17.5	Animated weather	265	18.13	Tides mode settings menus	280
17.6	Weather radar layer	266	CHAPTER 19 CHART APP - ANCHOR MODE		281
17.7	Cities and Surface observation stations layers.....	267	19.1	Anchor mode	282
17.8	Cloud top and Lightning layers.....	267	19.2	Anchor mode main menu	283
17.9	Sea surface temperature and Surface pressure layers.....	268	19.3	Setting up the anchor drag alarm	283
	Surface pressure patterns.....	268	19.4	Anchor mode settings menus	284
17.10	Storm cast and Storm tracks layers	269	CHAPTER 20 SAILING FEATURES		285
17.11	Wind and Watchbox layers.....	270	20.1	Chart app - Racing mode	286
17.12	Wave direction, wave height and wave period layers	271		Racing mode	286
17.13	Weather mode settings menus	272		Racing mode main menu	286
17.14	Weather settings menu	272		Racing mode settings menus	286
17.15	Weather subscription.....	272	20.2	Laylines.....	286
17.16	Glossary of weather terms	273		Layline data requirements.....	287
CHAPTER 18 CHART APP - TIDES MODE		275		Displaying and interpreting laylines	287
18.1	Tides mode.....	276		Fixed angles laylines	288
18.2	Tides mode main menu.....	276		Polar laylines	289

Wind shift data	292	Sonar minimum depths	309
20.3 Wind shift bar	293	21.3 Fishfinder app overview	309
20.4 Sail plan recommendations	294	Fishfinder app controls	310
Sail plan csv file layout	294	3D Vision channel controls	311
Importing a sail plan	295	21.4 Opening the Fishfinder app	311
20.5 Sailing data page	296	21.5 Sonar transducer calibration	313
20.6 Autopilot wind vane mode	296	Depth offset	313
Operating hints for wind vane mode	298	Setting a depth offset	313
Tacking in wind vane mode	298	Setting a temperature offset	313
Steering to wind (autopilot)	299	Ping depth limit	314
20.7 Race start line (SmartStart™) and Race timer	299	21.6 Sonar channels	314
Creating the Race start line	300	Selecting a Sonar channel	315
Starting the Race timer	301	21.7 Placing a Waypoint (Sonar, DownVision and SideVision)	315
Race laylines	302	Placing a waypoint in the 3D Vision channel	316
Race start page	302	21.8 Zoom mode	316
Race start sidebar	303	Zoom mode view	317
CHAPTER 21 FISHFINDER APP	304	21.9 Fish detection	317
21.1 Sonar technologies	305	21.10 Sonar scroll back (history)	318
Traditional sonar technology	305	21.11 Sonar sensitivity controls	319
CHIRP technology	305	21.12 Frequency tuning	319
CHIRP Sonar overview	305	21.13 Fishfinder settings menu	320
DownVision™ overview	306	21.14 Sonar display settings menu	320
SideVision™ overview	307	3D Vision sonar display settings	320
RealVision™ 3D overview	308	SideVision™ sonar display settings	321
21.2 Sonar module range	309	DownVision™ sonar display settings	322

CHIRP and traditional sonar display settings.....	323	22.9 AIS targets.....	341
21.15 Transducer settings menu.....	324	AIS target capacity.....	341
21.16 Sounder settings menu.....	324	AIS target list.....	341
21.17 Fish detection settings menu.....	325	AIS targets.....	342
21.18 Page settings menu.....	326	AIS settings menu.....	343
CHAPTER 22 RADAR APP.....	327	22.10 Radar targets.....	344
22.1 Radar app overview.....	328	Radar target acquisition data source requirements.....	344
Radar app controls.....	328	Radar targets.....	344
Radar app context menu.....	329	Acquiring a target manually.....	345
Camera tracking.....	331	Automatic target acquisition.....	345
22.2 Compatible Radar scanners.....	331	Radar target list.....	346
22.3 Radar feature comparison.....	332	Target settings.....	347
22.4 Opening the Radar app.....	335	Onscreen target settings.....	348
Putting the radar into standby.....	336	Clearing / resetting trails.....	348
Powering down your radar scanner.....	336	Target context menu.....	348
22.5 Set up and configuration.....	336	22.11 Target data reference mode.....	349
Selecting a Radar scanner.....	336	22.12 Dangerous targets alarm.....	349
Dual range.....	337	22.13 Guard zone alarms.....	350
Timed Radar transmission.....	337	22.14 Doppler Radar overview.....	350
Setting open array antenna size.....	337	Doppler mode.....	351
Check and adjust bearing alignment.....	338	Doppler data source requirements.....	351
22.6 Radar modes.....	338	22.15 Blank sectors.....	352
22.7 Range rings.....	339	22.16 Radar sensitivity controls.....	353
22.8 Range and bearing.....	340	22.17 Radar settings menus.....	353
VRM (Variable Range Marker) / EBL (Electronic Bearing Line).....	340	Transmission settings menu.....	354

View & Motion settings menu	354	Following a received route	368
Presentation settings menu	355	Cancelling a sent route	368
Preferences settings menu	356	23.8 Intel targets	369
Installation settings menu	356	Creating an Intel target	370
Advanced settings menu	357	Accessing target options	370
Page settings menu	358	Intel target options.....	370
CHAPTER 23 FIRST RESPONDER	359	Intel target list.....	370
23.1 First responder features.....	360	23.9 DSC targets	371
LightHouse software updates for STEDs		Accessing target options	371
enabled systems.....	361	DSC target options.....	371
Responder settings.....	361	DSC target list.....	371
Act in secondary mode	362	23.10 Target Of Interest (TOI).....	372
STEDS messaging transmission FIDs and		OneShot TOI decay times.....	373
checksums	362	TOI OneShot settings.....	373
NMEA 2000 messages	362	TOI transmission rates.....	373
23.2 Lost depth alarm	363	TOI position updates	374
23.3 Heading and SOG Homescreen status.....	363	Accessing target options	374
23.4 Settings password protection	363	TOI options	374
23.5 Data logging.....	364	TOI list.....	375
23.6 Waypoint at Range and Bearing from		23.11 First responder AIS modes.....	375
location.....	365	AIS mode status icons	375
23.7 Route sending and receiving	365	Blue Force Tracking.....	376
Broadcasting a route	366	23.12 AIS high target alarm.....	376
Sending a route using direct message.....	366	23.13 SITREP (Situation report).....	376
Adjusting Start time and Expiry time for		23.14 First responder target context menus.....	377
routes	367	23.15 Depth markers.....	378
Receiving a route	368		

Placing a depth marker	378	Display data	392
23.16 Import and export Waypoints and Routes over NMEA networks	378	25.4 Engine page	398
Importing Waypoints or Routes over NMEA 2000	379	25.5 Sailing page	399
Importing waypoints or routes over NMEA 0183	379	Sailing dials	400
Exporting waypoints or routes over NMEA 0183	381	25.6 Race start page	400
Waypoint, routes and tracks capacity	383	25.7 Navigation page	401
CHAPTER 24 MESSAGING APP	384	Close hauled angle indicators	402
24.1 Messaging app	385	25.8 Rolling road page	402
Transmission type	385	25.9 Fuel page	403
Message inbox	385	25.10 Tanks page	403
Broadcasting a new message	386	25.11 Bidata and single data pages	404
Sending a new direct message	387	25.12 Generators page	404
Replying to a message	387	Generator start/stop	406
Onscreen keyboard	387	25.13 CZone plug and play	406
Message symbols	388	Creating CZone digital switching pages automatically	406
CHAPTER 25 DASHBOARD APP	389	25.14 App menu	407
25.1 Dashboard app overview	390	Settings menu	407
Dashboard app onscreen controls	390	Pages settings menu	408
Switching data page	390	Circuits settings menu	409
Selecting data pages to display	390	Units settings menu	409
25.2 Default data pages	391	Engine RPM settings	411
25.3 Customizing a data item	391	Data response settings	411
		Page settings menu	412
		CHAPTER 26 MERCURY APP	413
		26.1 Mercury app overview	414

Mercury features.....	415	26.8 Sport exhaust	426
Splitscreen app pages.....	415	26.9 Steering angle indicator	426
Changing alternator voltage to steering angle indicator	416	26.10 Engine data page	426
System status.....	416	26.11 Faults	427
Engine warning messages	416	Fault code history	427
Mercury SmartCraft helm grouping.....	417	On Board Diagnostics (OBD)	428
Information messages.....	418	CHAPTER 27 YAMAHA APP	429
26.2 Mercury sidebar overview.....	418	27.1 Yamaha engine gateway selection.....	430
26.3 SkyHook mode	419	Compatible Yamaha gateways.....	430
BowHook mode	420	27.2 Yamaha HDMI overview	430
DriftHook mode	420	27.3 Yamaha app overview	430
26.4 Autopilot control	420	Requirements	431
Enabling and disabling Mercury® autopilot integration.....	421	Yamaha app controls.....	431
Engaging Autoheading.....	422	Switching data page	431
Engaging Route mode	422	27.4 Customizing Data pages.....	431
Disengage the autopilot (Standby).....	423	Available data items.....	431
26.5 Active Trim	423	27.5 Engine page.....	435
Setting up Active Trim	424	Engines	435
26.6 Troll control.....	424	Transmission	436
Enabling troll control	425	Status and warning indicators	436
Cancelling troll control.....	425	Tanks	437
26.7 Cruise control	425	Engine trim.....	437
Enabling cruise control.....	425	Troll mode	438
Cancelling cruise control	426	27.6 Settings	438
		Fault codes	438
		Maintenance	438

Advanced	438	Selected flags	464
CHAPTER 28 VIDEO APP	440	Goto flag	465
28.1 Video app overview	441	29.7 ClearCruise settings (Augmented Reality)	466
Video app pages	441	Range limit	466
Renaming video feeds	442	29.8 Roll correction	467
Video app controls	442	29.9 AR200 Calibration (Linearization)	468
Pan, Tilt, Zoom (PTZ) camera controls	442	Magnetic deviation	469
Image flip and mirroring	443	AR200 calibration settings	469
28.2 Thermal camera screen overview	444	Continual monitoring and adaptation	469
28.3 Opening the Video app	444	Compass lock	470
Selecting a video feed	446	CHAPTER 30 YOUTUBE & YOUTUBE TV	471
Dual streaming	446	30.1 YouTube TV	472
28.4 Video app settings	447	30.2 YouTube	472
28.5 Maritime (M-Series) camera compatibility	450	30.3 MFD controls	472
CHAPTER 29 CLEARCRUISE	456	CHAPTER 31 AUDIO APP	474
29.1 ClearCruise™ features	457	31.1 Audio app overview	475
29.2 Camera setup	458	Compatible entertainment systems	475
Fixed camera calibration	458	Audio app controls	476
Pan and Tilt camera calibration	459	Audio sidebar	478
29.3 AR200 setup for Augmented Reality	461	31.2 Opening the Audio app	479
29.4 ClearCruise™ Object Detection (Video Analytics) overview	461	31.3 Getting started	480
ClearCruise settings (Object Detection / Video Analytics)	462	Selecting an audio zone	480
29.5 Augmented Reality (AR) overview	463	Selecting an audio source	480
29.6 Augmented Reality flags	463	Muting and unmuting	480
		Browsing for tracks	481

Browsing for stations / channels	481	33.7 Controlling your display using RayControl	496
Saving presets	481	33.8 Controlling your display using RayRemote	497
Powering off entertainment systems	481	33.9 Viewing your MFD screen using RayView	497
31.4 Audio app menu options	482		
Audio app settings menu	482		
Adjusting balance and fade controls	483		
Adjusting multi-zone controls	484		
SR200 diagnostics mode	484		
CHAPTER 32 PDF VIEWER APP	486	CHAPTER 34 PARTNER INTEGRATION AND THIRD-PARTY APPS	498
32.1 PDF Viewer app overview	487	34.1 Partner integration	499
32.2 Opening PDF files	487	34.2 LightHouse third-party apps	499
32.3 PDF Viewer controls	488	34.3 App launcher	499
32.4 Searching a PDF	488	Installing Lighthouse third-party apps	500
CHAPTER 33 MOBILE APP SUPPORT	489	Removing an apk app	500
33.1 Raymarine mobile apps	490	34.4 Interface shortcuts on the homescreen	501
33.2 Connecting an Android device to the display	490	34.5 Bluetooth speaker set up	501
33.3 Connecting an iOS device to the display	491	Enabling and disabling Bluetooth	501
33.4 Raymarine app	491	Bluetooth Settings	501
How to obtain the Raymarine app	491	Pairing a Bluetooth speaker	502
LightHouse charts	492	Bluetooth volume control	502
Account settings	494	CHAPTER 35 YACHTSENSE ECOSYSTEM	503
33.5 Fishidy sync	495	35.1 YachtSense ecosystem	504
Enable sync	495	On-boat features	504
Disable sync	496	Off-boat premium features	506
33.6 Navionics plotter sync	496	35.2 How to obtain the Raymarine app	506
		How to connect guide	507
		Connect directly to a chartplotter (MFD)	507
		Display mirroring (view and control)	507

Transferring LightHouse charts.....	507	Performing a power on reset on an Axiom® 2 Pro display	520
Chartplotter file transfer	507	36.7 Radar troubleshooting	521
Connect to your YachtSense Link router	508	Changing Quantum radar channel.....	522
Geofencing.....	508	36.8 GNSS (GPS) troubleshooting.....	522
Data view and channel control.....	509	36.9 Sonar troubleshooting	523
User access management	509	Sonar depth data recording/logging.....	525
Boat alerts	509	Diagnostics sonar recording	525
Boat systems	510	36.10 Camera troubleshooting.....	527
35.3 Deleting a boat system.....	510	36.11 Augmented Reality (AR) Troubleshoot- ing.....	529
35.4 Unlinking (Removing) a router.....	511	36.12 Wi-Fi troubleshooting.....	530
35.5 YachtSense Link router account transfer / ownership transfer.....	513	36.13 IP address conflict troubleshooting	532
CHAPTER 36 TROUBLESHOOTING	514	36.14 Wireless display troubleshooting	533
36.1 Troubleshooting	515	36.15 Data troubleshooting.....	533
36.2 Diagnostic product information.....	515	36.16 Touchscreen troubleshooting.....	534
Saving product information	515	CHAPTER 37 TECHNICAL SUPPORT.....	535
Saving crash and system logs	515	37.1 Raymarine technical support and servicing.....	536
Saving YachtSense Link logs	516	Viewing product information	537
36.3 RNS-8 Diagnostic information	516	Remote Support via AnyDesk	537
36.4 NMEA 0183 diagnostics.....	517	37.2 Learning resources	538
36.5 NMEA 2000 diagnostics.....	518	APPENDIX A NMEA 0183 SENTENCE SUPPORT	539
36.6 Power up troubleshooting.....	519	APPENDIX B NMEA 2000 PGN SUPPORT	540
Performing a power on reset on touch only displays.....	520	APPENDIX C LIGHTHOUSE 4 SOFTWARE RELEASE HISTORY	543
Performing a power on reset on an Axiom® Pro display	520		

APPENDIX D PERIPHERAL PRODUCT SOFTWARE COMPATIBILITY	546
APPENDIX E HARDWARE AND SOFTWARE COMPATIBILITY.....	548
APPENDIX F ETHERNET (IPV4) NETWORKING OF RAYMARINE DEVICES WITH THIRD-PARTY PRODUCTS	550
APPENDIX G ANDROID APK COMPATIBILITY	553
APPENDIX H GLOSSARY	554
APPENDIX I DOCUMENT CHANGE HISTORY	558

CHAPTER 1: IMPORTANT INFORMATION

Safety warnings



Warning: Ensure safe navigation

This product is intended only as an aid to navigation and must never be used in preference to sound navigational judgment. Only official government charts and notices to mariners contain all the current information needed for safe navigation, and the captain is responsible for their prudent use. It is the user's responsibility to use official government charts, notices to mariners, caution and proper navigational skill when operating this or any other Raymarine product.



Warning: Minimum Safe Depth, Width and Height

Depending on cartography vendor, the *[Minimum safe depth]*, *[Minimum safe width]*, and *[Minimum safe height]* settings that you specify for your vessel will be used during automatic route generation. These settings will ensure that automatic routes are not generated in areas that are unsuitable for your vessel.

Minimum safe settings are user-defined calculations. As these calculations are outside of Raymarine's control, Raymarine will not be held liable for any damage, physical or otherwise, resulting from the use of the automatic route generation feature or the *[Minimum safe depth]*, *[Minimum safe width]* or *[Minimum safe height]* settings.



Warning: Maintain a permanent watch

Always maintain a permanent watch, this will allow you to respond to situations as they develop. Failure to maintain a permanent watch puts yourself, your vessel and others at serious risk of harm.



Warning: Distraction disclaimer

- The MFD/Chartplotter includes various entertainment apps. Whilst navigating do NOT let these apps distract your attention from safe navigation.
- Any distraction while navigating causes a lapse in concentration which increases the risk of collision. To avoid hazards you must give navigation your full attention at all times.



Warning: Autopilot usage

Autopilots navigate a preset course and do NOT respond to hazards automatically. The operator must remain at the helm at all times and be ready to avoid hazards and warn passengers of course changes.



Warning: Position holding/trolling features

A rotating propeller, moving vessel, or a device attached to a moving vessel can cause serious injury or death to people in the water. The MFD includes features which can control vessel engines and/or devices which can move the vessel. Stop the engines immediately whenever anyone is in the water near the vessel.



Warning: Automatic route generation

- Do NOT rely on automatically generated routes to guarantee that the route is safe to navigate. You MUST review the suggested route carefully and where necessary edit the route before following it.
- If a waypoint within any automatically generated route is added or moved the Automatic route generation algorithm will NOT be used, extra care should be taken to ensure that the route leg and any moved waypoints are safe to navigate.



Warning: Traffic separation

Automatic route generation features do not adhere to the Traffic Separation Schemes identified in Rule 10 of the *International Regulations for Preventing Collisions at Sea 1972* as amended.

Raymarine® therefore recommends that you do NOT use Automatic route generation to create any part of a route which will cross traffic lanes or pass near to traffic separation lines. In these situations Automatic route generation MUST be switched Off and the route or route leg MUST be built manually, ensuring compliance to the rules laid out in the above regulations.



Warning: Minimum Sonar Depth

Accurate bottom tracking can be unreliable in depths shallower than 0.8 m/2.62 ft. When operating at or below this depth be cautious of misleading sonar returns or false bottom tracking.



Warning: Radar transmission safety

The radar scanner transmits electromagnetic energy. Ensure all personnel are clear of the scanner when the radar is transmitting.



Warning: Sonar operation

- NEVER touch the transducer face when the sonar is powered on.
- SWITCH OFF the sonar if divers are likely to be within 7.6 m (25 ft) of the transducer.



Warning: Day mode brightness warning

Switching from Night mode to Day mode instantly increases the display brightness to maximum. This will impact the operator's night vision, due to the relative brightness of Day mode in night time conditions.

Product warnings



Warning: Anti virus protection

The system does not include protection against computer viruses. Before inserting any memory device ensure it is free from computer viruses by scanning the device with a suitable anti virus application with up to date virus definitions.

Electronic chart data

Raymarine does not warrant the accuracy of such information, and is not responsible for damages or injuries caused by errors in chart data or information utilized by the product and supplied by third parties. Use of electronic charts provided by third parties is subject to the supplier's End-User License Agreement (EULA).

Caution: Care of chart and memory cards

To avoid irreparable damage to and / or loss of data from chart and memory cards:

- Ensure that chart and memory cards are fitted the correct way around. DO NOT try to force a card into position.
- DO NOT use a metallic instrument such as a screwdriver or pliers to insert or remove a chart or memory card.
- Ensure correct memory card ejection procedure is carried out before removing the chart or memory card from the card reader.

Caution: Ensure card reader cover or door is securely closed

To prevent water ingress and consequent damage to the product, ensure that the card reader door or cover is firmly closed.

Caution: Sun covers

- If your product is supplied with a sun cover, to protect against the damaging effects of ultraviolet (UV) light, always fit the sun cover when the product is not in use.
- To avoid potential loss, sun covers must be removed when travelling at high speed, whether in water or when the vessel is being towed.

Caution: Product cleaning

When cleaning products:

- Switch off power supply.
- Use a clean damp cloth to wipe clean.
- Do NOT use: abrasive, acidic, ammonia, solvent or other chemical based cleaning products.
- Do NOT use a jet wash.

Regulatory notices

Disclaimer

Raymarine does not warrant that this product is error-free or that it is compatible with products manufactured by any person or entity other than Raymarine.

Raymarine is not responsible for damages or injuries caused by your use or inability to use the product, by the interaction of the product with products manufactured by others, or by errors in information utilized by the product supplied by third parties.

Third-party hardware, such as converters, adapters, routers, switches, Access Points etc., provided by third parties, may be made available directly to you by other companies or individuals under separate terms and conditions, including separate fees and charges. Raymarine UK Ltd or its affiliates have not tested or screened the third-party hardware.

Raymarine has no control over, and is not responsible for:

- (a) the content and operation of such third-party hardware; or

[Important information](#)

- (b) the privacy or other practices of such third-party hardware.

The fact that Raymarine's documentation may make reference to such third-party hardware does not indicate any approval or endorsement of any such third-party hardware. Raymarine may reference such third-party hardware only as a convenience.

THIS INFORMATION IS MADE AVAILABLE BY Raymarine ON THE BASIS THAT YOU EXCLUDE TO THE FULLEST EXTENT LAWFULLY PERMITTED ALL LIABILITY WHATSOEVER FOR ANY LOSS OR DAMAGE HOWSOEVER ARISING OUT OF THE USE OF THIS INFORMATION OR RELIANCE UPON THIS INFORMATION.

Raymarine does not exclude Raymarine's liability (if any) to you for personal injury or death resulting from Raymarine UK Ltd negligence, for fraud or for any matter which it would be illegal to exclude or to attempt to exclude.

End-User License Agreements (EULAs)

The EULAs for third-party electronic charts are available via the following links:

- **LightHouse charts:** — [LightHouse Navigation Charts EULA 84231-3-EN.pdf](#)
- **Navionics charts:** <https://www.navionics.com/usa/la>
- **CMAP charts:** <https://www.c-map.com/legal/terms-and-conditions-eula>

Open source license agreements

This product is subject to certain open source license agreements. Copies of the license agreements can be found on the Raymarine website: www.raymarine.com/manuals.

Regulatory approvals

Regulatory approvals are available to view on your display from the settings menu, [*Homescreen > Settings > Regulatory approvals*]

Warranty registration

To register your Raymarine product ownership, please visit <https://www.raymarine.com> and register online.

It is important that you register your product to receive full warranty benefits. Your unit package includes a bar code label indicating the serial number of the unit. You will need this serial number when registering your product online. You should retain the label for future reference.

IMO and SOLAS

The equipment described within this document is intended for use on leisure marine boats and workboats NOT covered by International Maritime Organization (IMO) and Safety of Life at Sea (SOLAS) Carriage Regulations.

Technical accuracy

To the best of our knowledge, the information in this document was correct at the time it was produced. However, Raymarine cannot accept liability for any inaccuracies or omissions it may contain. In addition, our policy of continuous product improvement may change specifications without notice. As a result, Raymarine cannot accept liability for any differences between the product and this document. Please check the Raymarine website (<https://www.raymarine.com>) to ensure you have the most up-to-date version(s) of the documentation for your product.

Publication copyright

Copyright ©2024 Raymarine UK Ltd. All rights reserved. No parts of this material may be copied, translated, or transmitted (in any medium) without the prior written permission of Raymarine UK Ltd.

CHAPTER 2: DOCUMENT INFORMATION

CHAPTER CONTENTS

- 2.1 Product documentation — page 28
- 2.2 Document conventions — page 28
- 2.3 Document illustrations and screenshots — page 29
- 2.4 Glossary — page 29

2.1 Product documentation

The following documentation is applicable to your product:

Applicable documents

- **81406** — LightHouse™ 4 Advanced Operation instructions (This document)
- **81393** — DockSense™ Alert operation instructions.
- **81398** — DockSense™ Control operation instructions.
- **81418** — Avikus NeuBoat Dock operation instructions.

This and other Raymarine product documents are available to download in PDF format from www.raymarine.com.

Related documents

- **87298** — Axiom® display Installation instructions
- **87414** — Axiom®+ display Installation instructions
- **87219** — Axiom® Pro display Installation instructions
- **87344** — Axiom® XL display Installation instructions
- **87443** — Axiom® 2 Pro display Installation instructions
- **87445** — Axiom® 2 XL display Installation instructions
- **81367** — RMK-10 Remote Keypad Installation and operation instructions
- **81351** — RMK-9 Remote Keypad Installation and operation instructions
- **81370** — LightHouse™ 3 Advanced Operation instructions
- **81405** — First responder LightHouse™ 3 operation instructions

User manuals Print Shop

Raymarine® provides a Print Shop service, enabling you to purchase a high-quality, professionally-printed manual for your Raymarine® product, delivered directly to your door.

Printed manuals are ideal for keeping onboard your vessel, as a useful source of reference whenever you need assistance with your Raymarine product.

The printed manuals are provided by a third-party (*lulu.com*).

To order a printed manual, visit: <https://www.lulu.com/search?q=raymarine> and then enter the document number you require into the Search box (e.g. *81406*).

Note:

- Accepted methods of payment for printed manuals are credit cards and PayPal.
- Printed manuals can be shipped worldwide.
- Further manuals will be added to the Print Shop over the coming months for both new and legacy products.
- Raymarine user manuals are also available to download free-of-charge from the Raymarine® website, in the popular PDF format. These PDF files can be viewed on a PC / laptop, tablet, smartphone, or on the latest generation of Raymarine® multifunction displays.

2.2 Document conventions

The following conventions are used throughout this document.

Formatting of user interface menus and settings.

References to menus, setting options and physical buttons are formatted using square brackets [].

Examples:

- “You can select your desired cartography from the *[Cartography selection]* menu.”
- “MFD apps are accessed from the *[Homescreen]*.”
- “Press the *[Home]* button to return to the Homescreen.”

Procedures for performing specific tasks using the product’s user interface.

The term “**Select**” is used to refer to the action of:

- Touchscreen control — using your finger to select a menu option or item on the screen.
- Physical buttons — Highlighting an item using the navigational controls and confirming the selection by pressing the *[OK]* button.

Examples:

- “Select *[OK]* to confirm your selection.”
- “Select *[Set-up]*”

Procedures for navigating menu hierarchies.

Menu hierarchies are used in this document to provide a quick summary on how to access a particular function or menu option.

Examples:

- “The internal sonar module is turned off from the Fishfinder app menu:
[Menu > Set-up > Sounder Set-up > Internal Sounder].”
- “The internal GPS can be switched off from the GPS settings menu:
[Homescreen > Status area > Satellites > Settings > Internal GPS].”

2.3 Document illustrations and screenshots

Note:

- Whilst care is taken to ensure that the illustrations and screenshots provided in this document portray the latest hardware and software versions available, where differences are purely aesthetic, some illustrations and screenshots may depict an older version of hardware or software.
- The navigation and/or sensor data shown in screenshots may be simulated data and therefore may not reflect real world conditions.

2.4 Glossary

A glossary of common terms and abbreviations used in this document can be found in the appendix.

Refer to: [p.554 – Glossary](#)

CHAPTER 3: SOFTWARE DETAILS

CHAPTER CONTENTS

- 3.1 Applicable software version — page 31
- 3.2 LightHouse MFD software compatibility — page 31
- 3.3 Compatible displays — page 31
- 3.4 New software features — page 32
- 3.5 Compatible peripheral product software — page 33
- 3.6 YachtSense Link network connection — page 34
- 3.7 Legacy eS and gS Series compatibility with Axiom displays — page 34
- 3.8 Software updates — page 35

3.1 Applicable software version

This handbook is applicable to Multifunction display operating system LightHouse 4 v4.6.103.

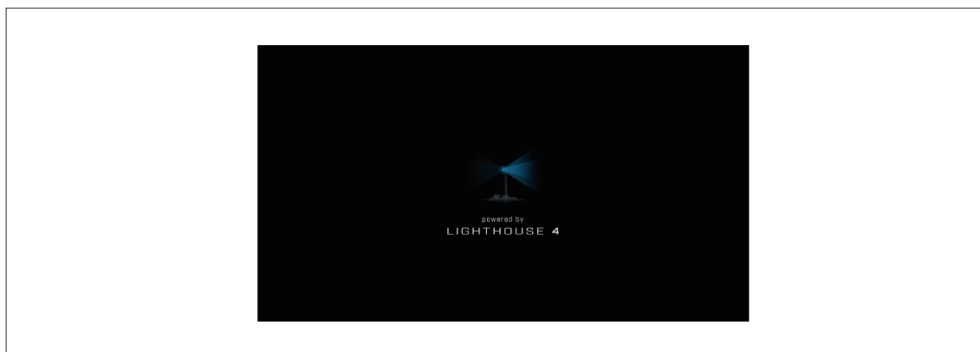

Product software is updated regularly to add new features and improve existing functionality. Check the website to obtain the latest software:

LightHouse 4 software download link

<https://www.raymarine.com/en-us/download/lighthouse-4-update-for-axiom-chartplotters>

3.2 LightHouse MFD software compatibility

The software version installed on Raymarine products must be compatible with the version of the LightHouse™ operating system installed on your MFD(s).

Note:

Where possible you should always update you peripheral product and MFD software to the latest available versions.

If you cannot upgrade your MFD to the latest available version then you must ensure that the version of software installed on your Raymarine products is compatible with the version of LightHouse™ installed on your MFDs.

3.3 Compatible displays

The LightHouse™ 4 operating system is compatible with the following displays:

Axiom® displays

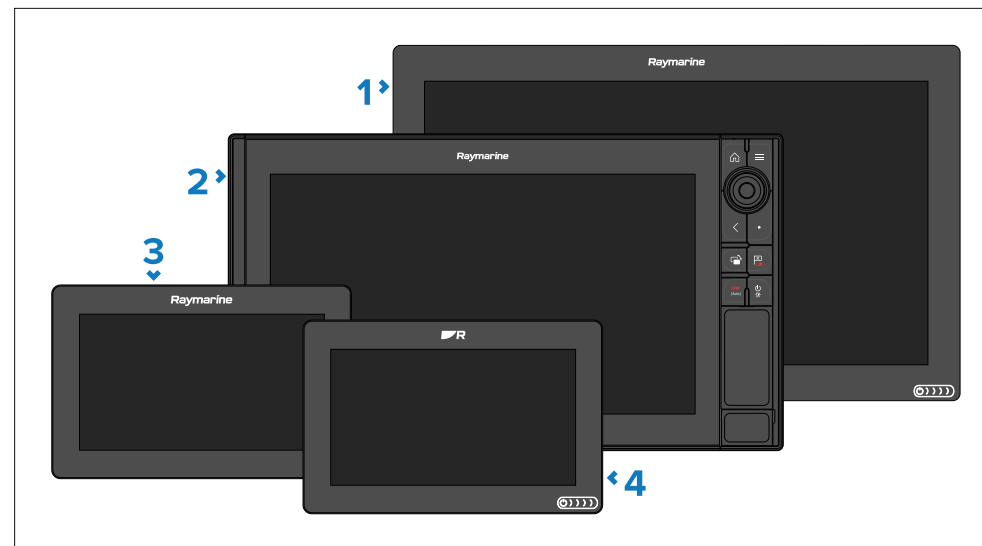

1. Axiom® XL
2. Axiom® Pro
3. Axiom®
4. Axiom® +

Axiom® 2 displays

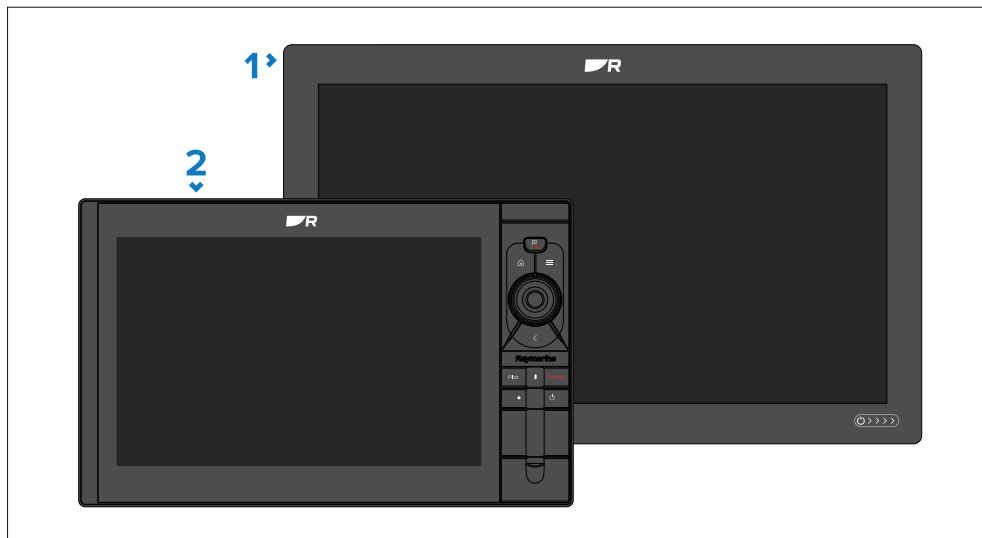

1. Axiom® 2 XL
2. Axiom® 2 Pro

3.4 New software features

The following new features have been added to v4.6.42 / v4.6.103 of the LightHouse 4 operating system.

This list includes *new features* only. It does NOT include software maintenance items, such as bug fixes or performance improvements.

To download the software, and view the complete list of all software updates, including new features, bug fixes, and performance improvements, visit:

Note:

When upgrading your display's software, it is important to ensure that you also upgrade any networked Raymarine products to their latest available software versions. The LightHouse 4 software package available on the website also includes the latest software for networked products.

LightHouse 4 software download link

<https://www.raymarine.com/en-us/download/lighthouse-4-update-for-axiom-chartplotters>

LightHouse 4 v4.6.42 / v4.6.103 New features:

Important:

LightHouse 4 software version v4.6.74 has been removed from distribution and should not be used. If you have updated to v4.6.74 it should be replaced with v4.6.103 as soon as possible.

General features:

- Added YouTube and YouTube TV MFD apps. For details refer to: [p.471 – YouTube & YouTube TV](#)
- New *[High speed alarm]* (SOG). For details refer to: [p.132 – High speed alarm](#)
- Maximum AIS targets that can be displayed simultaneously has been increased to 200. For details refer to: [AIS target capacity](#)
- Added *[Always Off]* LED option for Raymarine SeaTalk NG position sensors. For details refer to: [p.122 – Switching off sensor LEDs](#)
- Added *[Find me]* option for Raymarine SeaTalk NG position sensors. For details refer to: [p.123 – Find me](#)

First Responder new features:

- Added the ability to send and receive routes Over-The-Air (OTA). For details refer to: [p.365 – Route broadcast and receipt](#)
- Added *[Intercept distance]* and *[Time to target]* data in target context menus: [p.377 – First responder target context menus](#)
- Creeping line SAR pattern parameter name changed from *[Creep direction]* to *[Search orientation]*. Parallel line SAR pattern parameter name changed from *[Initial direction]* to *[1st leg direction]*. For details refer to: [p.174 – Creating a Creeping line / Parallel line search pattern](#)
- Added ability to receive and transmit NMEA 0183 sentence THS. For details refer to: [p.539 – NMEA 0183 sentence support](#)

Radar app features:

- Added *[True/Relative]* reference data toggle to Quick adjust menu and *[Individual target]* toggle to target context menus in Radar app. For details refer to: [p.349 — Target data reference mode](#)

Chart app new features:

- Added *[Steer to polar]* to Autopilot wind vane mode. For details refer to: [p.296 — Autopilot wind vane mode](#)
- Expanded available AIS target data. For details refer to: [Full AIS data](#)
- Added *[Quick adjust]* menu to Chart app. For details refer to: [p.193 — Quick adjust menu](#)
- Added new *[Nav marks]* selection of waypoint symbols. For details refer to: [p.158 — Waypoint symbols](#)
- New *[Fuel range]* ring in Chart app. For details refer to: [p.200 — Fuel range](#)

Dashboard app new features:

- Added ability to *[Start]* and *[Stop]* compatible generators. For details refer to: [p.406 — Generator start/stop](#)
- Added support for Jack Plate Position data using PGN 128780 and moved *[Exhaust gas temperature]* data item from *[Environment]* category to *[Engine]* category. For details refer to: [p.51 — Engine data](#)
- Added new GPS data items for Opposite Tack COG and Maximum all time SOG. For details refer to: [p.53 — GPS data](#)
- Added new *[Next leg TWA]*, *[Target apparent wind angle]* and *[Target true wind angle]* in *[Wind]* data category. For details refer to: [p.54 — Wind data](#)
- Added new *[Opp. tack COG]* data item, included *[Course over ground]* and renamed *[Tack heading]* to *[Opp. tack heading]* in *[Heading]* data category. For details refer to: [p.53 — Heading data](#)
- Added new *[Next track leg bearing]* data item, included *[Course to steer]* and *[Distance to go]* data items, improved naming of other data items in the *[Navigation]* data category. For details refer to: [p.53 — Navigation data](#)

Mercury app new features:

- Added integration of Mercury Skyhook, BowHook and DriftHook. For details refer to: [p.419 — Skyhook](#)

Feature removal

The following feature has been removed:

- UAV integration and the UAV MFD app have been removed.

[Software details](#)

Spotify app removal

The version of the Spotify app pre-installed on the LightHouse operating system for Axiom®, Axiom® +, Axiom® Pro and Axiom® XL displays is no longer fully functional. Therefore, the Spotify app is no longer included with the LightHouse™ 4 operating system for those displays. The latest compatible version of the app can be downloaded from the LightHouse apps page of the website: <https://www.raymarine.eu/multifunction-displays/lighthouse3/lighthouse-apps/> If you have upgraded from previous versions of LightHouse™ then the old version of the app may still be on your system.

Note:

The LightHouse operating system for Axiom® 2 Pro displays includes a compatible version of the Spotify app.

Before installing the new Spotify app, the old version must first be removed from your display.

For details on removing the app, refer to: [p.500 — Removing an apk app](#)

For details on installing a downloaded app, refer to: [p.500 — Installing Lighthouse third-party apps](#)

3.5 Compatible peripheral product software

Below is a list of products which have software updates required to remain compatible with the features and improvements introduced in the LightHouse 4 v4.6.42 / v4.6.103 software update:

Product	New software version
• Alpha 7 (E70649) Performance display.	v2.0.27
• Alpha 9 (E70650) Performance display.	
• AR200 (E70537) Augmented reality GNSS (GPS) and heading sensor.	v1.33 (Required for LED <i>[Off]</i> and <i>[Find me]</i> settings.)

Product	New software version
• RVX1000 (E70511) sonar module	v4.6.103
• RVM1600 (E70665) sonar module	
• RS150 (E70310) GNSS (GPS) Receiver	v1.29 (Required for LED <i>[Off]</i> and <i>[Find me]</i> settings.)
• p70 (E22166) / p70s (E70328) pilot controllers	v3.13 (Required to support MFD Wind vane mode.)
• p70R (E22167) / p70Rs (E70329) pilot controllers	
• RMK9 (A80217) keypad	v20.0.17
• RMK10 (T70293) keypad	
• EV-1 (E70096) Sensor core	v3.17
• EV-2 (E70097) Sensor core	v3.17

The new software will be included when downloading the latest LightHouse 4 option, which includes networked products.

3.6 YachtSense Link network connection

For optimum internet performance, Raymarine displays should be connected to the router via a wired RayNet Ethernet connection.

For YachtSense™ Link router software versions from **v4.20** onwards, it is no longer possible for a display to connect to the router's Wi-Fi Access Point.

Software version	Description
<i>Earlier than v4.20</i>	Display may be connected to the YachtSense™ Link router's Wi-Fi Access Point. However, functionality will be limited to providing an internet connection for third-party apps which require internet access, such as <i>Netflix</i> .
v4.20 or later	Display cannot connect to the YachtSense™ Link router's Wi-Fi Access Point.

Note:

For YachtSense™ Link routers which previously had a Wi-Fi connection to a display and have since been upgraded to **v4.20** from an earlier software version, the display will receive an IP address conflict notification. To correct the conflict, select *[Forget network]* in the displayed notification popup.

3.7 Legacy eS and gS Series compatibility with Axiom displays

As Raymarine® continues to develop new features and capabilities for the LightHouse™ 4 operating system, the ability to downgrade some Axiom® models to LightHouse™ software version v3.11.42 (for the purposes of allowing mixed networks of Axiom and legacy eS/gS Series displays) has ended.

Note:

Axiom® Pro **displays manufactured after August 2022** can no longer be downgraded to a version of LightHouse which is compatible with mixed systems which include legacy eS and gS Series displays.

The following table lists Axiom® displays and their compatibility status with legacy eS/gS Series displays:

Display	Compatibility in mixed systems featuring eS/gS Series displays
Axiom®	Yes — Software must be downgraded to LightHouse v3.11.42
Axiom® +	No — NOT compatible with eS/gS systems. The LightHouse OS cannot be downgraded
Axiom® XL	Yes — Software must be downgraded to LightHouse v3.11.42
Axiom® 2 XL	No — NOT compatible with eS/gS systems. The LightHouse 4 OS cannot be downgraded
Axiom® 2 Pro	No — NOT compatible with eS/gS systems. The LightHouse 4 OS cannot be downgraded
Axiom® Pro (pre-September 2022)	Yes — Software must be downgraded to LightHouse v3.11.42
Axiom® Pro (post-September 2022)	<p>No — Axiom® Pro displays manufactured after August 2022, and beginning with the following serial numbers, are NOT compatible with mixed systems featuring eS/gS Series displays:</p> <ul style="list-style-type: none"> • Axiom® Pro 9 RVX — E70371-1027106 • Axiom® Pro 12 RVX — E70372-0923640 • Axiom® Pro 16 RVX — E70373-1127908 • Axiom® Pro 9 S — E70481-1026853 • Axiom® Pro 12 S — E70482-0924052 • Axiom® Pro 16 S — E70483-1026473

If you wish to continue using a mixed system of newer Axiom displays and legacy eS/gS displays, you must ensure that these displays are NOT connected on the same RayNet or SeaTalk NG networks.

3.8 Software updates

Raymarine regularly issues software updates for its products, which provide new and enhanced features and improved performance and usability. It's important to ensure that you have the latest software for your products by regularly checking the Raymarine website for new software releases.

To check for the latest software updates and the software update procedure for your specific product(s) refer to: <https://www.raymarine.com/software>

Unless otherwise stated, software updates for Raymarine products are performed using a Raymarine MFD/chartplotter.

- Where applicable, you should always backup your user data and settings before performing a software update.
- To update SeaTalk NG products you must use the datamaster MFD/Chartplotter which is physically connected to the SeaTalk NG backbone.
- Ethernet (RayNet) products can be updated from any MFD/Chartplotter on the same network as the product to be updated.
- In order to perform a software update, any connected Autopilot or Radar must be switched to Standby.
- The MFD's/Chartplotter's "Check online" feature is only available when the MFD has an Internet connection.

Note:

If in doubt as to the correct procedure for updating your product software, refer to your dealer or Raymarine technical support.

Checking current software

The network settings menu provides details of the MFDs and connected devices software version.

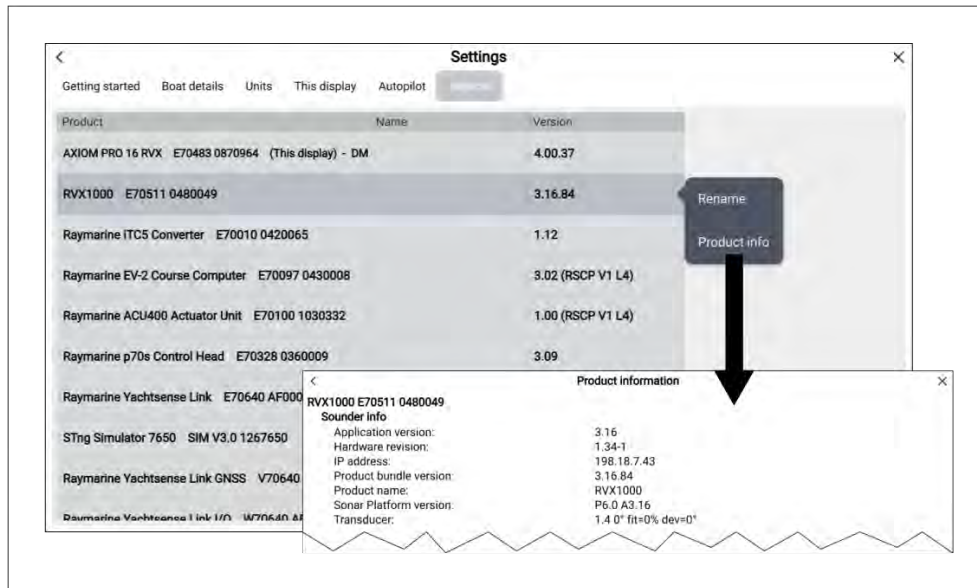

1. Open the *[Network]* settings menu: *[Homescreen > Settings > Network]*. A list of connected devices is displayed. The version column identifies the devices current software version.
2. Select a product from the list and then select *[Product Info]* from the pop-over menu to view more details about a product.

Caution: Installing software updates

- The software update process is carried out at your own risk. Before initiating the update process ensure you have backed up any important files.
- Ensure that the product(s) has a reliable power supply and that the update process is not interrupted.
- Damage caused by an incomplete update is not covered by Raymarine warranty.
- By downloading the software update package, you agree to these terms.

Updating software from a memory card

The display's and connected Raymarine device's software can be updated from a memory card containing the software update files. Follow the steps below to install software using a memory card.

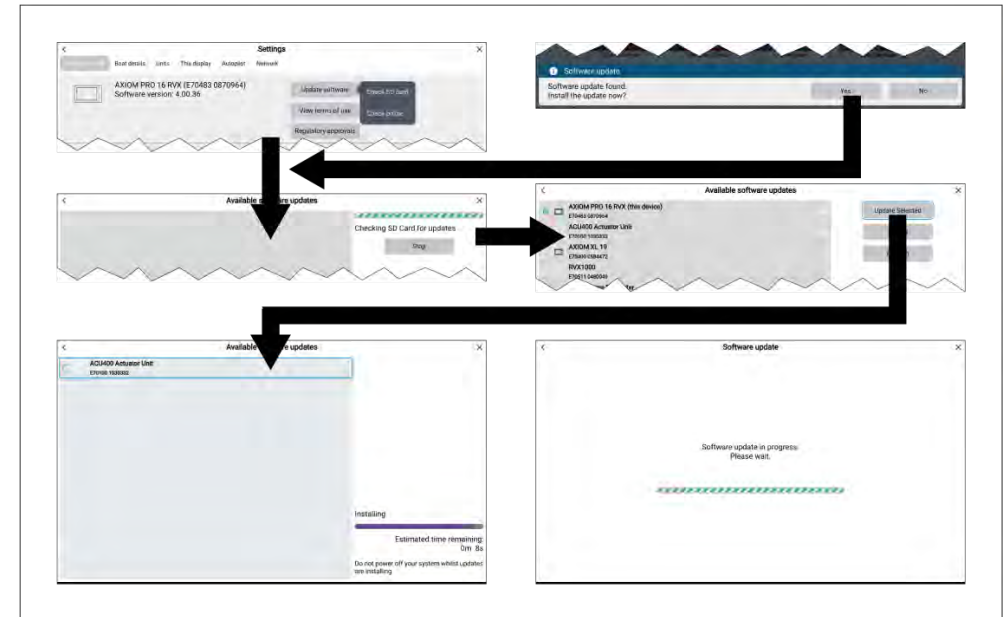

Note:

- Zipped/compressed files must be unzipped/decompressed before copying to memory card.
- Axiom® 2 displays require a different download file from Axiom® displays.

1. Check the software version of your product(s).
2. Compare your product(s) current software version to the latest version available on the Raymarine website www.raymarine.com/software
3. Download any newer software versions for your product(s).
4. Copy the files to a MicroSD card.
5. With your display powered on, insert the MicroSD card into the card reader slot.

Your display will automatically detect software files.

6. Select *[Yes]* on the new software found notification.
If the update is not automatically detect you can select Check SD card from the Update software pop-over menu available on the Getting started settings menu: *[Homescreen > Settings > Getting started > Update software > Check SD card]*.
7. The display will check your MicroSD card for available software updates and display a list of devices for which software updates are available.
8. Ensure that the relevant products in the list are selected.
You can select and deselect product(s) by selecting them in the list.
9. Select *[Update selected]* to commence the update process.
Networked displays will all show the software update in progress screen until all software updates are complete. During this time you will not be able to interact with your displays.

Updating software over the internet

The display's and connected Raymarine device's software can be updated by connecting the MFD to the internet and checking online for available software updates. Follow the steps below to install software available online.

1. Select *[Update software]* from the *[Getting started]* settings menu: *([Homescreen > Settings > Getting started > Update software])*.
2. Select *[Check online]* from the pop-over menu.
3. If the display has an existing wired or Wi-Fi connection to the internet the display will check the internet for available software updates and display a list of devices for which software updates are available.
4. If the display does not currently have internet access, select *[Wi-Fi settings]*, connect the display to a Wi-Fi access point/hotspot that has an internet connection, and then select the *[Back]* triangle at the bottom of the screen.
5. Ensure that the relevant products in the list are selected.
Products for which software updates are available will automatically be selected. You can deselect product(s) by removing the tick next to the relevant item in the list.
6. Select *[Update selected]* to commence the update process.
Any networked displays will show a 'software update in progress' message until all software updates are complete. During this time you will not be able to interact with your displays.

For further details regarding internet connections on the display, refer to:
[p.84 – Internet connection](#)

CHAPTER 4: GENERAL INFORMATION

CHAPTER CONTENTS

- 4.1 Memory card compatibility — page 39
- 4.2 Applications and integrations — page 42
- 4.3 Menu types — page 43
- 4.4 Setting controls — page 44
- 4.5 Alarm and information notifications — page 45
- 4.6 Sidebar — page 46
- 4.7 Alpha Series sidebar operations (LightHouse™ 4 MFD) — page 48
- 4.8 Data overlays — page 49
- 4.9 Display data — page 50
- 4.10 Sonar depth data recording/logging — page 56

4.1 Memory card compatibility

MicroSD memory cards can be used to backup / archive data (e.g. Waypoints, Routes and Tracks). Once data is backed up to a memory card, old data can be deleted from the system. The archived data can be retrieved at any time. It is recommended that your data is backed up to a memory card on a regular basis.

Compatible cards

The following types of MicroSD cards are compatible with your display. **If the card's native format does not match one of the display's supported formats, the card will not be recognized by the display. In this situation, it will be necessary to re-format the card using a separate device, such as a laptop or PC for example.**

Type	Size	Native card format	Display supported Format
MicroSDSC (Micro Secure Digital Standard Capacity)	Up to 4GB	FAT12, FAT16 or FAT16B	NTFS, FAT32, exFAT
MicroSDHC (Micro Secure Digital High Capacity)	4GB to 32GB	FAT32	NTFS, FAT32, exFAT
MicroSDXC (Micro Secure Digital eXtended Capacity)	32GB to 2TB	exFAT	NTFS, FAT32, exFAT

- **Speed class rating** — For best performance it is recommended that you use Class 10 or UHS (Ultra High Speed) class memory cards, or better.
- **Use branded memory cards** — When archiving data it is recommended that you use good quality branded memory cards.

Caution: Care of chart and memory cards

To avoid irreparable damage to and / or loss of data from chart and memory cards:

- Ensure that chart and memory cards are fitted the correct way around. DO NOT try to force a card into position.
- DO NOT use a metallic instrument such as a screwdriver or pliers to insert or remove a chart or memory card.
- Ensure correct memory card ejection procedure is carried out before removing the chart or memory card from the card reader.

Removing MicroSD card from its adaptor

MicroSD memory and cartography chart cards are usually supplied inserted into an SD card adaptor. The card will need to be removed from the adaptor before inserting into your display.

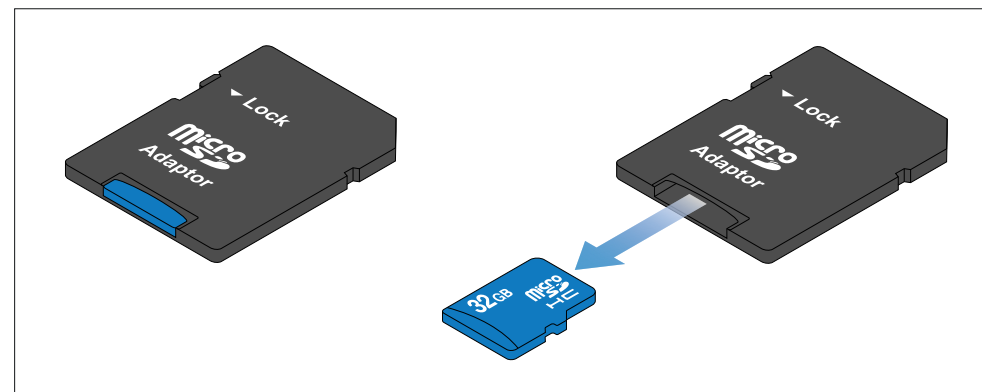

Inserting a MicroSD card — Axiom® and Axiom®+ displays

Axiom® and Axiom®+ displays have a single slot MicroSD card reader located on the rear of the display.

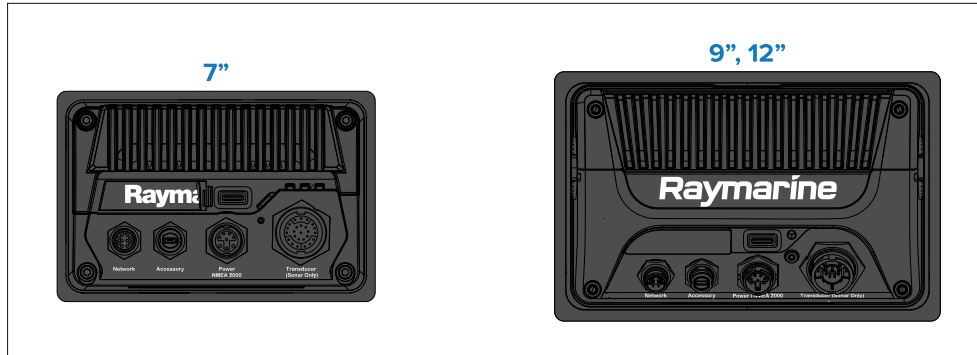

1. Pull back the microSD card reader cover as shown above.
2. Insert your microSD card with the contacts facing down.
3. Close the cover and ensure it is seated correctly.

Removing a MicroSD card

1. Select *[Eject SD card]* from the *[Import/export]* page: *[Homescreen > My data > Import/export > Eject SD card.]*
2. Open the card reader cover.
3. Remove the MicroSD card from the Rear of the display.
4. Ensure you close the card reader's cover.

Inserting a MicroSD card — Axiom® 2 Pro displays

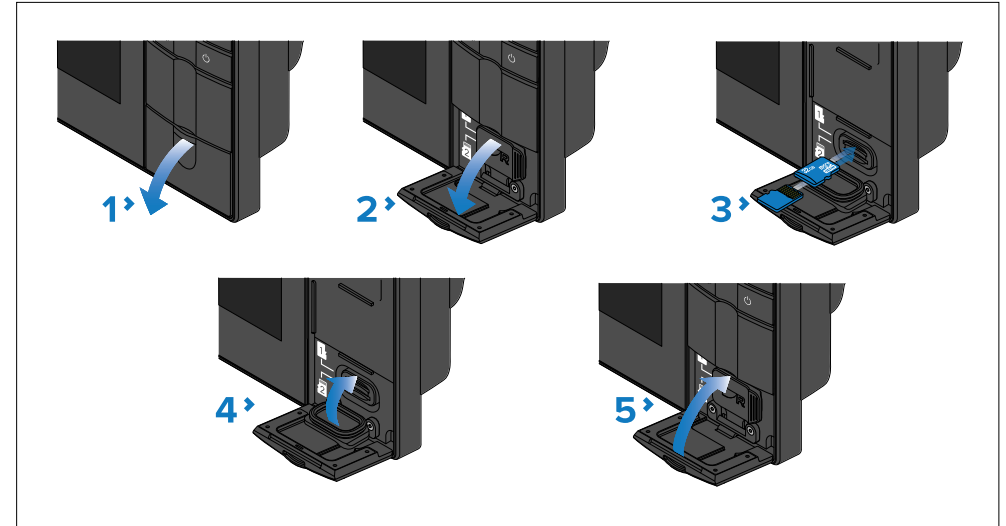

1. Open the card reader door.
2. Pull down the card slot cover.
3. Insert the card(s) into a card slot and push until they clicks into place.

Important:

The upper card slot requires the memory cards contacts to be pointing downwards. The lower card slot requires the memory card contacts to be pointing upwards.

4. Close the card slot cover, ensuring it is seated correctly.
5. Close the card reader door.

Removing a MicroSD card

1. Open the card reader door.
2. Pull down the card slot cover.
3. Hold the *[Power]* button to access the *[Shortcuts]* menu, and then select the *[Eject SD Card]* option.
4. Push the card in until it clicks.
5. Pull the card free from the card slot.
6. Close the card slot cover, ensuring it is seated correctly.
7. Close the card reader door.

Inserting a MicroSD card — Axiom® Pro displays

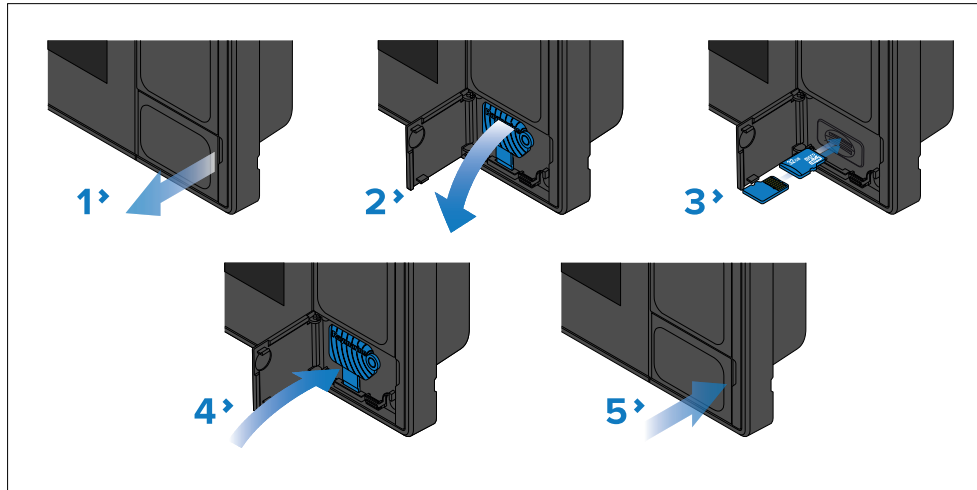

1. Open the card reader door.
2. Pull down the card slot cover.
3. Insert the card(s) into a card slot and push until they clicks into place.

Important:

The upper card slot requires the memory cards contacts to be pointing downwards. The lower card slot requires the memory card contacts to be pointing upwards.

4. Close the card slot cover, ensuring it is seated correctly.
5. Close the card reader door.

Removing a MicroSD card

1. Open the card reader door.
2. Pull down the card slot cover.
3. Hold the *[Power]* button to access the *[Shortcuts]* menu, and then select the *[Eject SD Card]* option.
4. Push the card in until it clicks.
5. Pull the card free from the card slot.
6. Close the card slot cover, ensuring it is seated correctly.
7. Close the card reader door.

[General information](#)

Inserting memory card into external storage devices

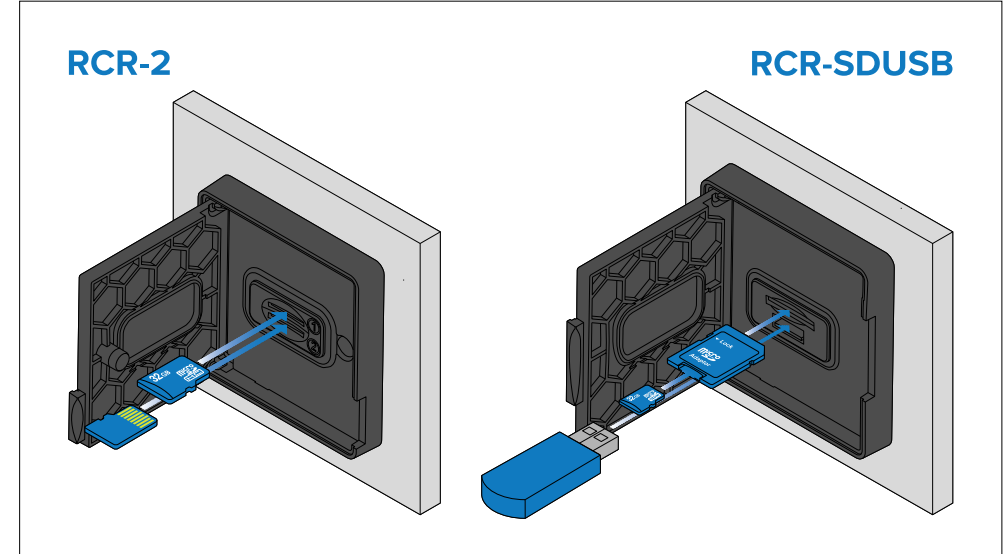

1. Open the card reader door.
2. Insert the storage device into a card slots as follows:
 - RCR-SDUSB slot 1 — With the contacts facing down, insert an SD card (or an SD card adaptor containing a MicroSD card) into the upper slot and push until it clicks into place.
 - RCR-SDUSB slot 2 — With the contacts facing down, insert a USB drive directly into the lower slot.
 - RCR-2 slot 1 — With the contacts facing down, insert a MicroSD card into the upper slot and push until it clicks into place.
 - RCR-2 slot 2 — With the contacts facing up, insert a MicroSD card into the lower slot and push until it clicks into place.

Important:

RCR-2 external card readers are not compatible with Axiom® 2 displays.

Removing external storage (SD and MicroSD)

With the card reader door open:

1. Use the display's **Power** button to access the *[Shortcuts]* menu, and then select the *[Eject SD Card]* option.

2. Push the card in until it clicks.
3. Pull the card free from the card slot.

Removing external storage USB drive

With the card reader door open and cover pulled down:

1. Pull the drive free from the card slot.

Caution: Ensure card reader cover or door is securely closed

To prevent water ingress and consequent damage to the product, ensure that the card reader door or cover is firmly closed.

4.2 Applications and integrations

LightHouse™ 4 displays support native LightHouse display apps, approved third-party apps, and also integrations with select partner hardware interfaces.

MFD apps

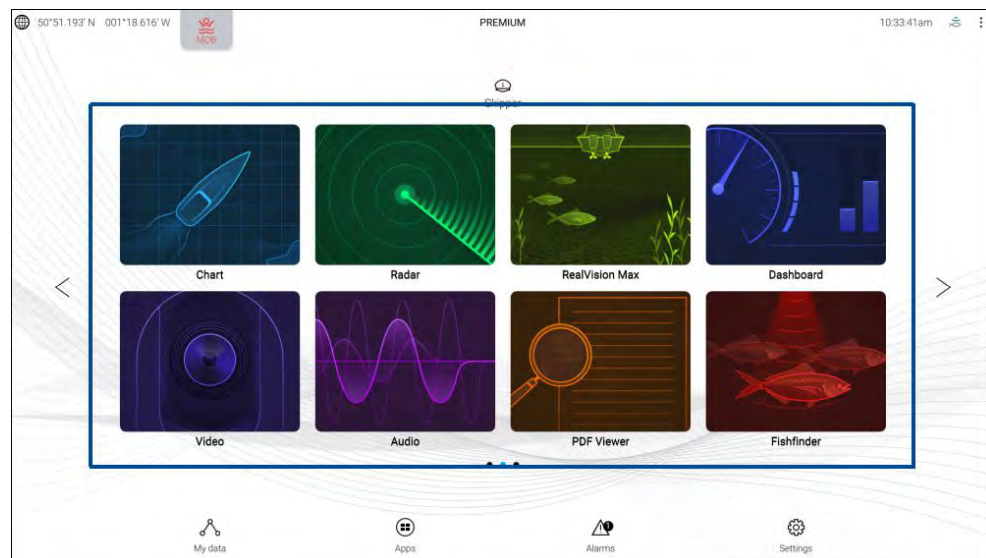

LightHouse MFD apps are an integral part of the operating system and are accessed using app page icons available on the Homescreen. App page icons can contain one fullscreen app, or multiple apps in a splitscreen arrangement.

For more details about LightHouse MFD apps, refer to: [p.89 – MFD Apps](#)

LightHouse™ third-party apps

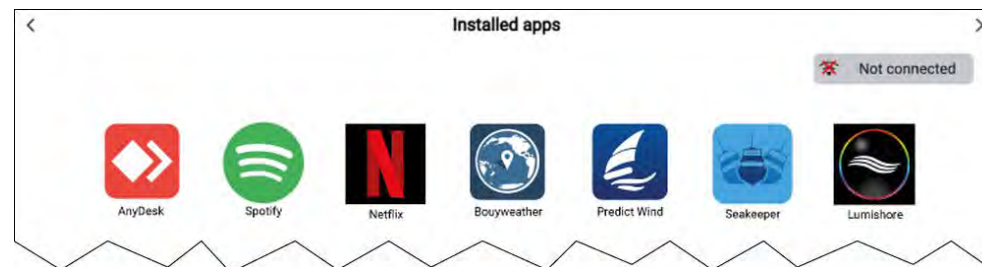

LightHouse™ third-party apps are apps that are developed entirely by third parties, and are approved for use on the MFD by Raymarine. These apps are accessed from the LightHouse app launcher found on the Homescreen.

For more details about third-party apps, refer to: [p.499 – LightHouse third-party apps](#)

Partner integrations

The LightHouse™ operating system also enables partner organizations to integrate the user interface of their hardware so it can be accessed using the MFD. When compatible partner hardware is detected, icons can be displayed on the Homescreen and in the App launcher.

For more details about partner integration, refer to: [p.499 – Partner integration](#)

4.3 Menu types

The LightHouse™ operating system uses several types of menus which contain settings and options for your MFD.

MFD app main menu

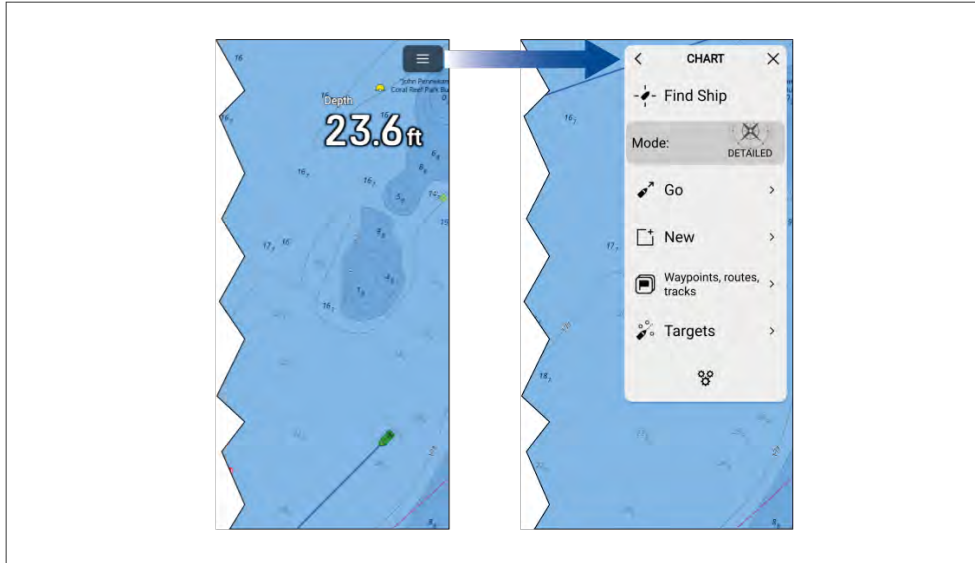

Each MFD app includes a main menu that provides access to the app's settings and functions.

The MFD app main menu is accessed by selecting the menu icon located in the top right of the screen.

Selecting the [\leftarrow] (Back), [\times] (Close) icons or selecting an area of the screen away from the menu, will close the menu.

Selecting a menu item with a [\rightarrow] (right arrow) will open a settings page or other menu options related to that item.

Settings pages

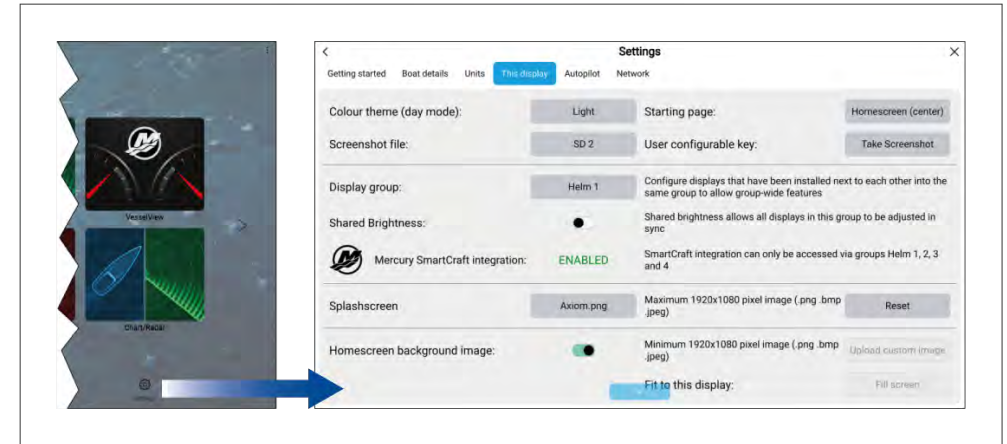

Settings pages are fullscreen pages containing settings and menu options. Settings pages are usually laid out using tabs to group similar settings together.

Settings pages are accessed by selecting the [*Settings*] icon located on the bottom right of the homescreen or the bottom of each MFD app main menu. Other settings pages are also available by selecting menu items that have a [\rightarrow] (right arrow) located on the right side of the menu option.

Selecting tab titles in settings pages will display the contents for that tab.

Selecting the [\leftarrow] (Back) or [\times] (Close) icons will close the menu.

Context menus

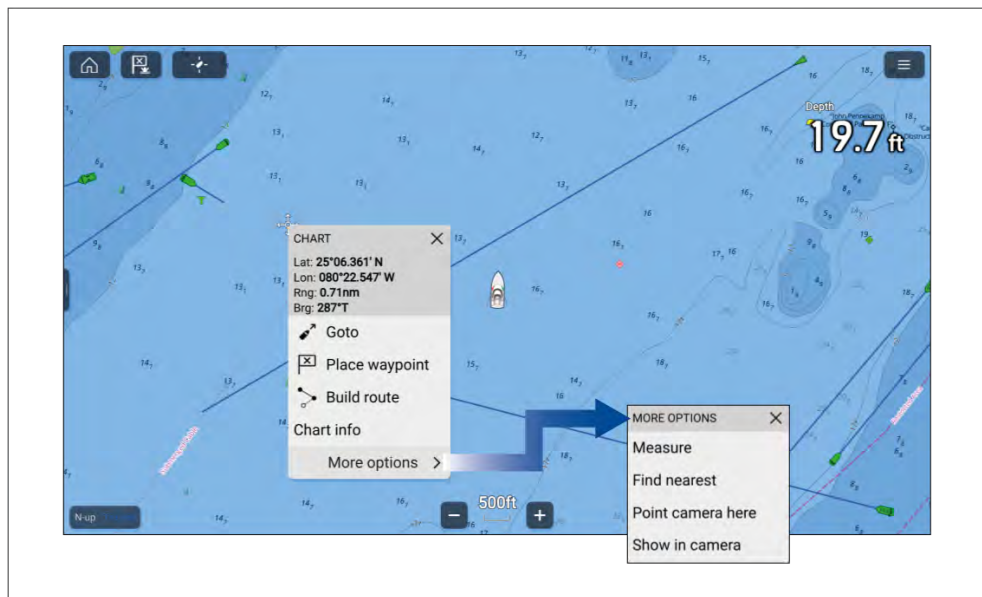

Context menus are available in MFD apps. Context menus are accessed by pressing and holding (highlighting with cursor and pressing [OK] button) on an onscreen object or location within an MFD app.

Context menus provide context-sensitive information and options.

Selecting [more options] will display further menu options.

Selecting [X] (Close) or selecting an area of the screen away from the menu will close the menu.

Pop-over menus

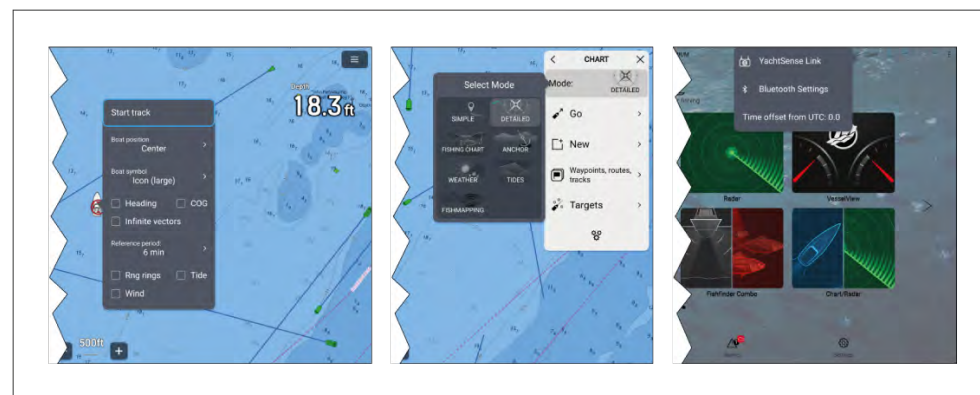

Pop-over menus are available on the homescreen, in MFD apps and from settings pages. Pop-over menus provide access to further menu options and settings.

Selecting an area of the screen away from the menu will close the menu.

4.4 Setting controls

Various controls are available to aid settings adjustments.

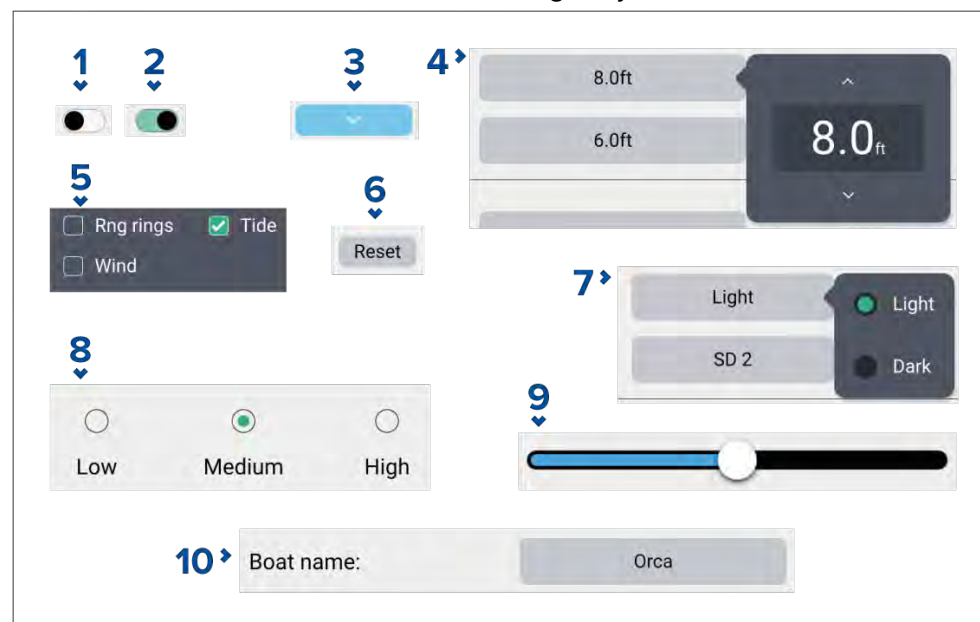

1. **Toggle switch** in off state (i.e.: disabled). Select to enable option.
2. **Toggle switch** in on state (i.e.: enabled). Select to disable option.
3. **Page down button** — selecting the page down button will scroll the current menu or settings page (when the page down button is visible you can also swipe to scroll up/down).
4. **Setting field numeric value** — selecting will display the numeric adjustment control you can then use the up and down arrows to adjust the value.
5. **Tick boxes** — when a tick is displayed in the box the option is enabled. Select the box to enabled and disable the option.
6. **Setting button** — selecting the button will perform the related procedure or acknowledge a notification.
7. **Setting field options** — selecting will display a pop-over menu with the available options, selecting an option will change selection to that option.
8. **Radio buttons** — selecting an option will change selection to that option.
9. **Slider control** — usually used for setting percentages, select and slide circle to adjust value.
10. **Setting field text value** — selecting will display the onscreen keyboard you can then enter the desired text.

4.5 Alarm and information notifications

Alarms, warnings and information notifications are used to notify you to a situation or hazard that requires your attention. Notifications are triggered by system functions and external devices connected to the MFD (Multifunction Displays). Alarm and warning notifications are displayed on all networked MFDs.

Standard colors are used to signify the notification type.

Alarm notifications

Dangerous alarms



Red — A red notification is used to signify a dangerous condition. Dangerous alarms are used to signify that immediate action is required due to the potential of danger to life or vessel.

Warning alarms

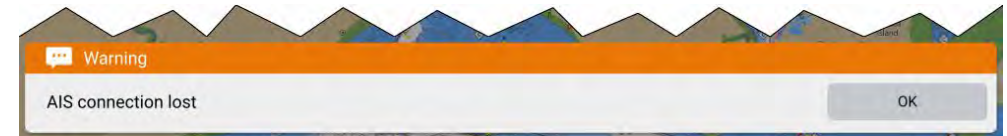

Alarms are accompanied by an audible tone. The alarm notification and audible tone will continue to be displayed until acknowledged, or until the condition that triggered the alarm is no longer present. Acknowledged alarms may remain active whilst the alarm condition persists, but will not trigger further onscreen or audible notifications. Active and historical alarms can be viewed in the *Alarms Manager*, accessible from the homescreen: [*Homescreen > Alarms*].

Amber — An amber notification is used to signify a warning condition. Warning alarms are used to signify that there has been a change in situation that you need to be aware of, and that action may be required.

For further details about alarms, refer to: [p.127 — Alarms manager](#)

Information notifications

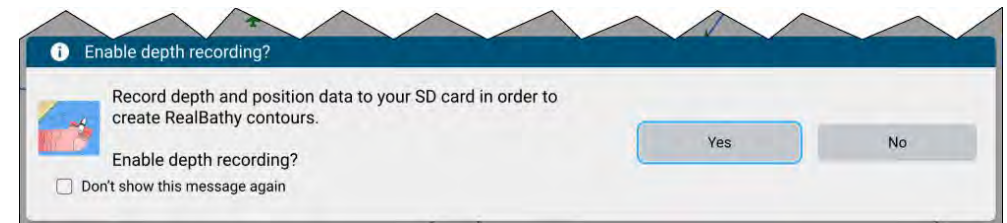

Blue — A Blue notification is used to signify information requiring user acknowledgement, and may also provide options. Unless they require user interaction, information notifications may self-dismiss after 3 seconds. Information notifications are not accompanied by an audible tone, and are not listed in the *Alarms Manager*.

4.6 Sidebar

The Sidebar is available in all app pages that are accessed from the Homescreen. The sidebar provides quick access to system data.

The sidebar is accessed using the touchscreen.



1. A short left-to-right swipe when touching the sidebar control (“handle”) on the left edge of the screen displays the sidebar. A long swipe displays the sidebar and sidebar menu.
2. With the sidebar open, a left-to-right swipe on the sidebar opens the sidebar menu. A right-to-left swipe closes the sidebar.
3. With the sidebar menu displayed, you can select a sidebar icon to display that sidebar. A right-to-left swipe closes the sidebar menu. The sidebar menu automatically closes after approximately 10 seconds of inactivity.
4. To permanently display the sidebar,, select and hold on a sidebar icon, and then select the pin icon. When pinned, the sidebar cannot be closed by swiping and must be unpinned before you can close the sidebar.

Selecting the ‘X’ located on the top right of the sidebar closes the sidebar and sidebar menu.

The Sidebar is opened automatically in the Chart app when a *[Goto]* or *[Follow]* action is initiated.

Sidebar selector

Selecting an icon from the sidebar selector will display that sidebar.

The following sidebars are available:

	<p>Data 1 — The Data 1 sidebar is a default sidebar that is always available. The default data items are:</p> <ul style="list-style-type: none"> • Vessel position (Lat/Lon) • COG (Course Over ground) • SOG (Speed Over ground) • BTW (Bearing To Waypoint) • DTW (Distance To Waypoint) • Rudder bar (rudder position) <p>The data items can be customized.</p>
	<p>Data 2 — The Data 2 sidebar is a default sidebar that is always available. The default data items are:</p> <ul style="list-style-type: none"> • Active waypoint (Waypoint name) • Wpt TTG (Waypoint Time To Go) • Wpt ETA (Waypoint Estimated Time of Arrival) • BTW (Bearing To Waypoint) • DTW (Distance To Waypoint) • Rudder bar (rudder position) <p>The data items can be customized.</p>



Search — The Search sidebar is a default sidebar that is always available. The sidebar provides data and options relevant for following SAR (Search And Rescue) patterns. The available data items are:

- Brg to CSP (Bearing to Commence Search Point)
- Leg 1
- Leg 2
- Target SOG
- TTP (Time To Perpendicular) — This is the time (based on current speed) for the vessel to either reach the waypoint's arrival circle or if aiming outside the arrival circle, for the vessel to pass perpendicular to the waypoint, with respect to the current track leg.
- COG (Course Over ground)
- Advance wpt
- XTE (Cross track error)
- SOG (Speed Over ground)
- Stop Route
- Rudder bar (rudder position)

The data items cannot be customized

Note:

Brg to CSP, Leg 1 and leg 2 will update as your route progresses to show current leg and subsequent 2 legs.



Alpha display — The Alpha display sidebar is available when 1 or more Alpha series performance displays are on the network. The sidebar enables control of Alpha series performance displays. The following controls are available:

- *[Display]*— When more than 1 Alpha display is connected you can select which display to control.
- *[Page]*— Use the arrow buttons to cycle though the selected display's pages.
- *[Brightness]*— Use the buttons to adjust the selected display's brightness level.





Pilot — The Pilot sidebar is available when the MFD has *[Pilot control]* enabled. Refer to: [p.140 — Autopilot control](#)
The data and options displayed on the sidebar are dependent on autopilot mode. Refer to: [p.142 — Pilot sidebar](#)
The displayed data and options cannot be customized.



Race start — The Race start sidebar is available when a sailing activity is chosen during the MFD's initial startup wizard.
For details of the controls available refer to: [p.303 — Race sidebar](#)
The displayed data and options cannot be customized.

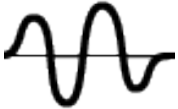

Trolling — The Trolling sidebar is available when a compatible Trolling motor is detected.
For details of the options available refer to: [p.147 — Trolling motor control](#)
The controls cannot be customized.

	<p>Audio — The Audio sidebar is available when compatible audio equipment is connected. For details of the options available refer to: p.478 — Audio sidebar The displayed options cannot be customized.</p>
	<p>Mercury — The Mercury sidebar is available when compatible Mercury SmartCraft engines are detected. For further details refer to: p.418 — VesselView Sidebar The displayed data cannot be customized.</p>

Customizing data sidebars

The data displayed in sidebars **Data 1** and **Data 2** can be customized by following the steps below.

With the **Data 1** or **Data 2** sidebar displayed:

1. Press and hold on the data item you want to customize.
2. Select *[Edit]* from the pop-over menu.
3. Select the data item that you want to be displayed.

4.7 Alpha Series sidebar operations (LightHouse™ 4 MFD)

Some Alpha display functions can be invoked remotely when using a Raymarine® LightHouse™ 4 (version 4.5 or later) multifunction display / chartplotter connected to the same network as your Alpha display(s). These functions are split between either the multifunction display / chartplotter's *[Network]* page (for configuration-based options) and *[Sidebar]* menu (for features often required whilst sailing).

When viewing an application on your multifunction display / chartplotter, you can swipe from the left edge of the screen to display the *[Sidebar]* menu. From there, select *[Alpha display]* in order to invoke the following functions remotely:

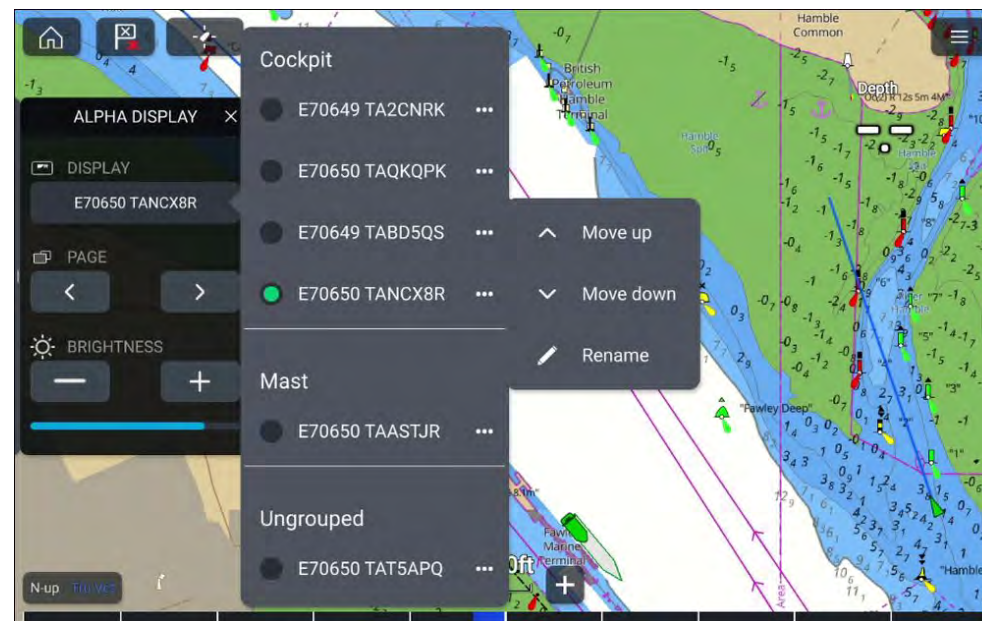

Note:

The *[Display]* option and its available sub-options are only available if more than one Alpha Series display is networked to the same system as your multifunction display / chartplotter.

- *[Display]* — Indicates the current performance display that is being operated via the *[Sidebar]* menu. A different performance display can be operated by selecting the *[Display]* option and choosing a different display from the list shown. Each Alpha Series display is sorted according to the display group that it has been assigned to.
- *[...]* — Opens a menu with additional options:
 - ◆ *[Rename]* — Displays an onscreen keyboard which can be used to edit the selected Alpha display's name.
 - ◆ *[Move up]* — Moves the selected Alpha display up within the list by one position, if multiple Alpha displays are available. This option is disabled if your Alpha display has reached the top of the display group that it has been assigned to.
 - ◆ *[Move down]* — Moves the selected Alpha display down within the list by one position, if multiple Alpha displays are available. This option is

disabled if your Alpha display has reached the bottom of the display group that it has been assigned to.

- *[Page]*— Switches between the selected Alpha display’s data pages. Data pages can be cycled through either using the *[<]*left option or *[>]*right option.
- *[Brightness]*— Increases or decreases the selected Alpha display’s screen brightness. Brightness can be changed using the *[+]*increase option or *[-]*decrease option. The current screen brightness is indicated by the *[Brightness bar]*below the *[+]*and *[-]*options.

Alpha Series network operations (LightHouse™ 4 MFD)

Some functions can be invoked remotely when using a Raymarine® LightHouse™ 4 (version 4.5 or later) multifunction display / chartplotter which is connected to the same network as your Alpha performance display(s). These functions are split between either the multifunction display / chartplotter’s *[Network]*page (for configuration-based options) and *[Sidebar]* menu (for features often required whilst sailing).

The following configuration related functions can be invoked from the LightHouse™ 4 *[Network]*page: *[Homescreen > Settings > Network]*

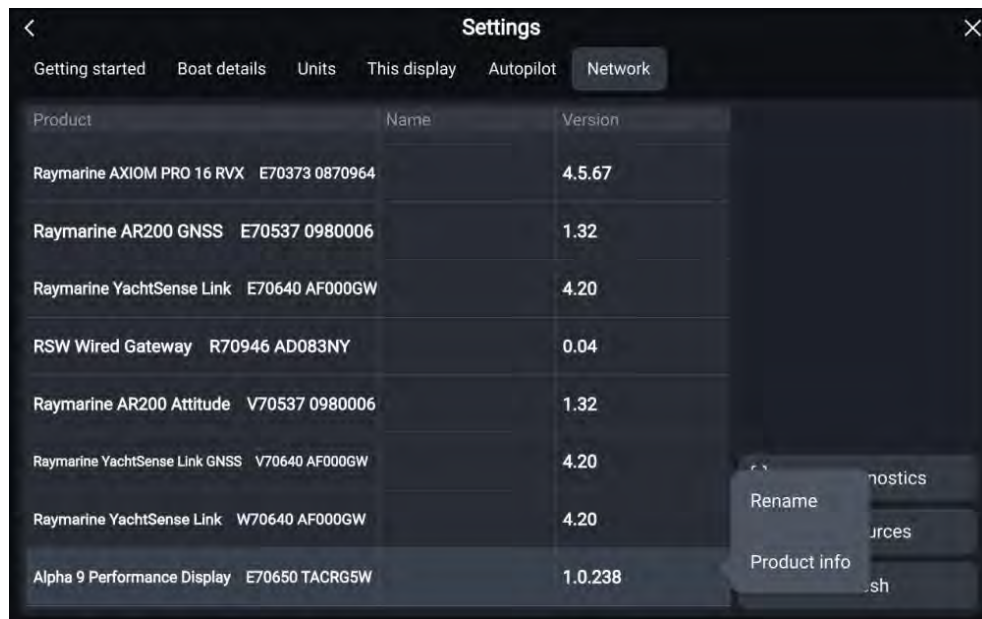

- *[Rename]*— Renames the selected performance display. If no *[Name]*has been set, the unit model and serial number will appear instead if the unit is selected on your multifunction display / chartplotter’s *[Network]*tab.
- *[Product information]*— Displays a series of product information related to the selected performance display.

4.8 Data overlays

Data overlays can be used to display system data on homescreen app pages.

Up to 4 data overlays can be added to each app page. Data overlays are not available for the Mercury VesselView app or for fullscreen partner integration interface pages.

Data overlays can be added, customized or deleted by selecting *[Edit data overlays]*from the app’s *[Page settings]* menu: *[Menu > Settings > Page settings > Edit data overlays]*.

In edit mode you can customize existing data overlays by selecting it to display the pop-over menu.

From the pop-over menu the following options are available:

- Change the data item in a data overlay by selecting *[Edit]*and choosing a new data item from the list.
- Change the location of a data overlay by selecting *[Move]*and then moving it to a new location.
- Change the size of a data overlay by selecting *[Resize]*and choosing either *[Small]*, *[Medium]*, *[Large]*or *[Extra large]*.
- Remove a data overlay by selecting *[Delete]*

Adding a data overlay

New data overlays can be added following the steps below.

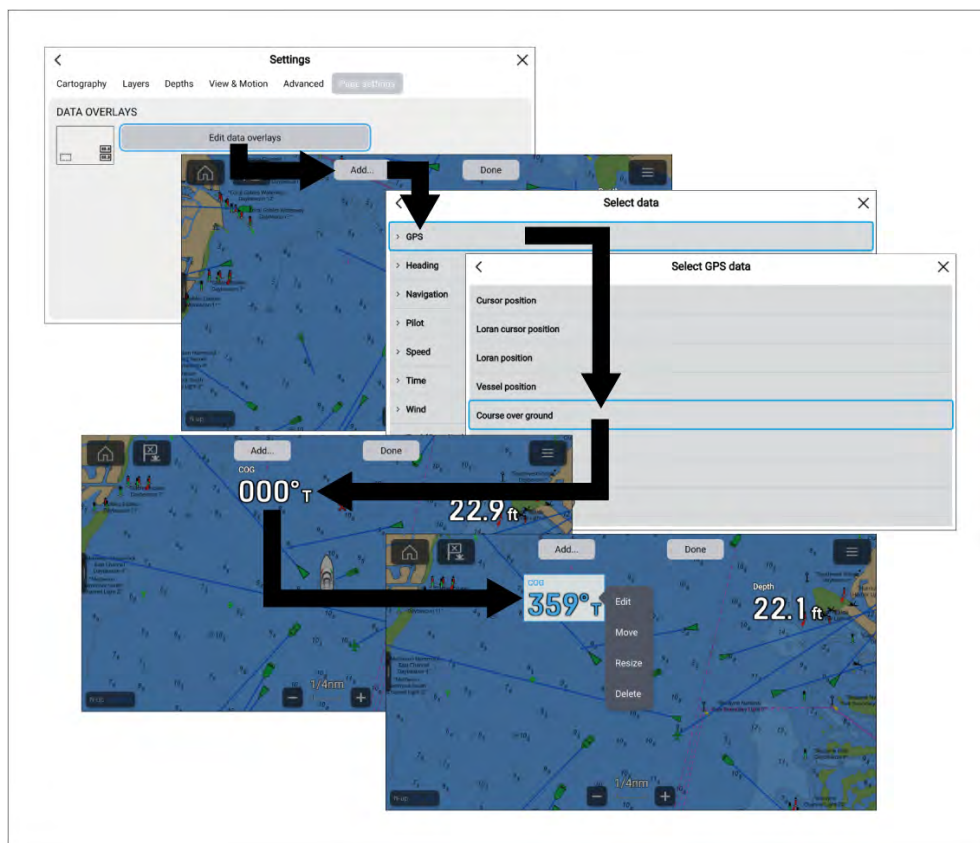

1. Select *[Edit data overlays]* from the *[Page settings]* menu: *[Menu > Settings > Page settings.]*
2. Select *[Add]* or select and hold on a location and select *[Add new]*.
3. Select a data category from the list.
4. Select a data item from the list.
5. If required select and hold on the new data overlay and drag it to a new location.
6. Select *[Done]* to confirm the new data overlay(s).

4.9 Display data

Data transmitted by compatible devices connected to the same network as the display, as well as data generated by the display, can be shown as data items in the Dashboard app, the sidebar and as a data overlay.

Data items are organized into categories.

Note:

- Standard NMEA 2000 PGNs are listed next to the relevant data items.
- Supported Raymarine and third-party proprietary messages are not listed.
- NMEA 0183 sentences are not shown.

To view a list of all supported NMEA 2000 PGNs, refer to: [p.540 – NMEA 2000 PGN support](#)

To view a list of all supported NMEA 0183 sentences, refer to: [p.539 – NMEA 0183 sentence support](#)

To change or add a data item in the Dashboard app or sidebar, select and hold on the data cell and select *[Edit]* from the pop-over options to display the list of data categories.

To change or add a data item to a data overlay, use the *[Page settings]* menu from the relevant MFD app. For details, refer to: [p.49 – Data overlays](#)

Battery data

Batteries are detected automatically by the display.

If no compatible batteries are detected the *[Battery]* category will be hidden.

The following data items are available in the *[Battery]* category:

- *Battery voltage* (PGN 127508)
- *Battery current* (PGN 127508)
- *Time till zero charge* (PGN 127506)
- *Battery temperature* (PGN 127508)
- *State of charge* (PGN 127506)

The data items will be available for each detected battery.

Detected batteries are shown in the battery configuration page: *[Homescreen > Settings > Boat details > Num of batteries > Configure batteries]*.

Boat data

Boat data requires supported sensors to be connected.

The following data items are available in the *[Boat]* category:

- ⁽¹⁾ *Sail recommendation (Main)*
- ⁽¹⁾ *Sail recommendation (Headsail)*
- *Rudder angle* (PGN 127245)
- *Rate of turn* (PGN 127251)
- ⁽²⁾ *Roll* (PGN 127257)
- ⁽³⁾ *Steering angle*
- *Mast rotation*
- *Pitch* (PGN 127257)
- ⁽¹⁾⁽²⁾ *Sail recommendation*
- *Trim tabs*⁽¹⁾ (PGN 130576)

Note:

- (1) Requires Sailing activity and imported Sail plan.
- (2) Data item can only be displayed in the Dashboard app.
- (3) Requires Mercury engine integration.

Depth data

Depth data requires a compatible instruments or sonar transducer connected to the display.

The following data items are available in the *[Depth]* category:

- *Maximum depth*
- *Minimum depth*
- *Depth* (PGN 128267)

Display data

The display data category is used for voltage detected by the display.

The following data items are available in the *[Display]* category:

- *Supply voltage*
- *Supply voltage level*⁽¹⁾

[General information](#)

Note:

- The display category and data items are not available in the Dashboard app.
- (1) Data item is only available in the sidebar.

Distance data

Distance data requires a compatible speed transducer and or GNSS receiver.

The following data items are available in the *[Distance]* category:

- *Distance to line*
- *Distance to tack*
- *Trip (manual)*
- *Trip (month)*
- *Trip (day)*
- *Trip (season)*
- *Ground log* (PGN 128275)
- *Trip* (PGN 128275)
- *Log* (PGN 128275)
- *Log Trip*⁽¹⁾ (PGN 128275)
- *Line bias*

Note:

- (1) Data item is only available in the Dashboard app

Engine data

Engine data requires the display to be connected to a supported engine management system. Depending on manufacturer a compatible engine interface or gateway may be required.

The following data items are available in the *[Engine]* category:

- *Exhaust Gas Temperature* (PGN 130316)
- *Engine*

The following items will be available for each engine.

- *Jack plate position* (PGN 128780)

- *RPM* (PGN 127488)
- *Engine trip* (PGN 127497)
- *Trans oil temp* (PGN 127493)
- *Fuel flow (avg)* (PGN 127497)
- *Trans oil pressure* (PGN 127493)
- *Gear* (PGN 127493)
- *Oil temperature* (PGN 127489)
- *Alternator* (PGN 127489)
- *Boost pressure* (PGN 127488)
- *Oil pressure status* (PGN 127489)
- *Oil pressure* (PGN 127489)
- *Engine hours* (PGN 127489)
- *Coolant temperature* (PGN 127489)
- *Coolant pressure* (PGN 127489)
- *Fuel pressure* (PGN 127489)
- *Fuel flow (inst)* (PGN 127489)
- *Tilt position* (PGN 127488)
- *Engine load* (PGN 127489)
- *Fuel flow* (PGN 127489)

Engine configuration settings are available in the *[Boat details]* settings menu: *[Homescreen > Settings > Boat details > Num of engines]*.

Fuel data

The fuel data category include items related to fuel management. Fuel management is dependent on engine data being available on the SeaTalk NG® backbone.

The following data items are available in the *[Fuel]* category:

- *Total propulsive fuel (vol)*
- *Total fuel (vol)* (PGN 127505)
- *Total fuel (%)*
- *Fuel (vol)⁽¹⁾*
- *Fuel (%)⁽¹⁾*

- *Fuel used (trip)* (PGN 127497)
- *Est. fuel remaining* (PGN 127496)
- *Engine economy total* (PGN 127497)
- *Time to empty* (PGN 127496)
- *Distance to empty* (PGN 127496)
- *Fuel flow total* (PGN 127497 / PGN 127489)
- *Fuel used (season)* (PGN 127497)

The data items above will be available for each configured fuel tank. When more than 1 fuel tank is configured then the data items will be provided in the *[All Tanks]* category and will combine the fuel data items for all tanks.

Note:

(1) For systems with multiple fuel tanks these data items will remain available for each individual tank.

Environment data

Environmental data items require connection of compatible sensors and transducers.

The following data items are available in the *[Environment]* category:

- *True wind chill*
- *App wind chill* (PGN 130312 / 130316)
- *Max water temp*
- *Min water temp*
- *Water temp* (PGN 130310 / 130311 / 130312 / 130316)
- *Max air temp*
- *Min air temp*
- *Drift* (PGN 129291)
- *Dew point* (PGN 130312 / 130316)
- *Barometric pressure* (PGN 130310)
- *Air temp* (PGN 130310)
- *Set* (PGN 129291)
- *Humidity* (PGN 130310 / 130311 / 130313)

- *Sunset Sunrise*⁽¹⁾
- *Set Drift*⁽¹⁾ (PGN 129291)
- *Water & Supply*⁽¹⁾

Note:

- (1) Data items are only available in the Dashboard app

Inside environment data

Inside environmental data items require connection of compatible sensors.

The following data items are available in the *[Inside environment]* category:

- *Inside humidity* (PGN 130313)
- *Inside temperature* (PGN 130316)

The data items above will be available for the number of interior environmental sensors specified in the *[Boat details]* settings menu: *[Homescreen > Settings > Boat details > Num of interior environment sensors]*.

GPS data

The GPS data category contains data items related to the GNSS receiver in use by your display.

The following data items are available in the *[GPS]* category:

- *Cursor position*
- *Loran cursor position*
- *Loran position*
- *Course over ground* (PGN 129026)
- *Average SOG*
- *Maximum SOG*
- *Speed over ground SOG* (PGN 129026)
- *Vessel position* (PGN 129025 / PGN 129029)
- *COG SOG* (Course Over Ground) (Speed Over ground)⁽¹⁾ (PGN 129026)
- *Opp. tack COG* (PGN 129026)
- *Maximum SOG (all time)* (PGN 129026)

Note:

- (1) Data item is only available in the Dashboard app

Heading data

Heading data requires a connected sensor providing vessel heading.

The following data items are available in the *[Heading]* category:

- *Steer to layline*⁽¹⁾
- *Heading error*
- *Locked heading*
- *Heading* (PGN 127250)
- *Opp. tack COG*
- *Course over ground*
- *Opp. tack heading*
- *Locked heading & Error*⁽²⁾
- *Heading & Speed*⁽²⁾

Note:

- (1) *[Steer to layline]* data will only be populated when the boating activity has been set to sailing in the initial MFD start up wizard.
- (2) Data item is only available in the Dashboard app.

Navigation data

Navigation data requires a compatible sensor providing position related data. Active navigation is required for waypoint and route related data items.

The following data items are available in the *[Navigation]* category:

- *Sailing time to waypoint*
- *Sailing distance to waypoint*
- *Next waypoint*
- *Loran target position*
- *Cross tack error* (PGN 129283)

- *Time to waypoint*
- *Time to destination*
- *Target position*
- *ETA at waypoint (time & date)* (Estimated Time of Arrival) (PGN 129284)
- *ETA at destination (time & date)* (Estimated Time of Arrival) (PGN 129284)
- *Course to steer*
- *Next track leg bearing*
- *Distance to waypoint*
- *Distance made good*
- *Course made good*
- *Bearing origin to waypoint*
- *Bearing to waypoint*
- *Active waypoint*
- *ETA at destination* (Estimated Time of Arrival)
- *ETA at waypoint* (Estimated Time of Arrival) (PGN 129284)
- *Distance to go*
- *CTS & DTW⁽¹⁾* (Course To Steer & Distance To Waypoint)
- *CMG & VMG⁽¹⁾* (Course Made Good & Velocity Made Good)
- *BTW & DTW⁽¹⁾* (Bearing To Waypoint & Distance To Waypoint)
- *Waypoint info⁽¹⁾*
- *CMG & DMG⁽¹⁾* (Course Made Good & Distance Made Good)

Note:

(1) Data item is only available in the Dashboard app

Pilot data

A rudder reference transducer is required for pilot data items.

The following data items are available in the *[Pilot]* category:

- *Rudder angle* (PGN 127245)
- *Steering angle* (Requires Mercury engine integration.)

Speed data

Speed data includes data items related to vessel speed.

The following data items are available in the *[Speed]* category:

- *VMG to waypoint* (Velocity Made Good)
- *Speed thru water* (PGN 128259)
- *VMG to windward* (Velocity Made Good)
- *Avg speed*
- *Max speed*
- *Maximum SOG (all time)*
- *Target speed*
- *Polar performance⁽¹⁾*

Note:

(1) *[Polar performance]* data will only be populated when the boating activity is set to **Sailing** in the initial MFD start up wizard.

Time data

Time data requires a compatible device to be connected providing time data.

The display the following data items are available in the *[Time]* category:

- *Sunset time*
- *Sunrise time*
- *UTC date* (Universal Time Coordinated) (PGN 129033)
- *UTC time* (Universal Time Coordinated) (PGN 129033)
- *Race timer*
- *Date* (PGN 126992)
- *Time* (PGN 126992)
- *Time to tack*
- *Time to burn*

Wind data

Wind data requires a compatible wind transducer to be connected.

The following data items are available in the *[Wind]* category:

- *Next leg TWA* (PGN 128259 & 130306)
- *Target Apparent Wind Angle* (PGN 128259 & 130306)
- *Target True Wind Angle* (PGN 128259 & 130306)
- *Wind shift*
- *True wind angle* (PGN 128259 & 130306)
- *Cardinal*
- *Beaufort*
- *Ground wind direction* (Ground Wind Direction) (PGN 130306 / 129026)
- *Ground wind speed* (Ground Wind Direction) (PGN 130306 / 129026)
- *True wind direction* (PGN 128259 & 130306 & 127250)
- *Minimum true wind angle*
- *Maximum true wind angle*
- *Minimum true wind speed*
- *True wind speed* (PGN 128259 & 130306)
- *Maximum app wind speed*
- *App wind speed* (PGN 130306)
- *Minimum app wind angle*
- *App wind angle* (PGN 130306)
- *Maximum app wind angle*
- *Minimum app wind speed*
- *Minimum true wind speed*
- *GWD & Beaufort*⁽¹⁾ (Ground Wind Direction) (PGN 130306 / 129026)
- *GWS & GWD*⁽¹⁾ (Ground Wind Speed & Ground Wind Direction)
- *AWA & VMG*⁽¹⁾ (Apparent Wind Angle & Velocity Made Good)
- *AWA & AWS*⁽¹⁾ (Apparent Wind Angle & Apparent Wind Speed)
- *TWA & VMG wind*⁽¹⁾ (True Wind Angle & Velocity Made Good)
- *TWA & TWS*⁽¹⁾ (True Wind Angle & True Wind Speed)

Note:

(1) Data item is only available in the Dashboard app

Tank level data

Tank level data shows the percentage fill for each detected tank.

The following data categories are available for tanks:

- *Fuel (Gasoline)*
- *Fresh water* (PGN 127505)
- *Live well* (PGN 127505)
- *Grey water* (PGN 127505)
- *Black water* (PGN 127505)

Each tank type has its own data category and if more than 1 tank of each type is detected there will be subcategory for each tank.

Generator data

The generator data category is only available when a generator transmitting supported NMEA 2000 PGNs is detected by the display.

The following data items are available in the *[Generator]* category:

- *Engine load* (PGN 127489)
- *Engine RPM* (PGN 127488)
- *Fuel flow* (PGN 127489)
- *Coolant temperature* (PGN 127489)
- *Oil temperature* (PGN 127489)
- *Oil pressure* (PGN 127489)
- *Oil pressure (status)* (PGN 127489)
- *Generator battery voltage* (PGN 127508)
- *Engine hours* (PGN 127489)
- *Exhaust gas temperature* (PGN 130316)
- *Generator state* (PGN 127514)
- *Generator voltage* (PGN 127751)
- *Generator current* (PGN 127751)

The data items above will be available for each detected generator.

- *Generator line 1 power* (PGN 127744)
- *Generator line 1 current* (PGN 127744)

- *Generator line 1 to neutral voltage* (PGN 127747)
- *Generator line 1 to line 2 voltage* (PGN 127747)
- *Generator line 1 frequency* (PGN 127747)
- *Generator line 2 power* (PGN 127745)
- *Generator line 2 current* (PGN 127745)
- *Generator line 2 to neutral voltage* (PGN 127748)
- *Generator line 2 to line 3 voltage* (PGN 127748)
- *Generator line 2 frequency* (PGN 127748)
- *Generator line 3 power* (PGN 127746)
- *Generator line 3 current* (PGN 127746)
- *Generator line 3 to neutral voltage* (PGN 127749)
- *Generator line 3 to line 1 voltage* (PGN 127749)
- *Generator line 3 frequency* (PGN 127749)

The additional data items above will be available for each detected 3 phase generator.

Load cell data

Load cells are sensors used to measure the load bearings on key rigging components, such as forestay, sidestay, backstay, or any sheet, halyard, control line, vang, tack line, or runner.

A predefined list of *[Load cells]* is available.

For load cell data to be populated a supported load cell gateway is required.

Cyclops Marine load cells

Cyclops Marine is a third party company providing wireless load-sensing devices for use in sailing, and especially race sailing.

The Cyclops Marine sensors connect wirelessly to the below-deck Cyclops Marine Gateway, which interfaces with compatible Raymarine MFDs and displays key load bearings at identified stress points on a yacht's rigging.

In the MFD's Dashboard app, you can see at a glance the live, static and dynamic load data transmitted by the Cyclops Marine sensors, at up to 50 sensor placements.

4.10 Sonar depth data recording/logging

The MFD includes features that will record or log your vessel's depth and position data.

Vessel depth and position logging features:

- **RealBathy™** — In the chart app when using LightHouse™ charts, the RealBathy™ feature logs vessel depth and position to enable creation of personalized depth contours that can be displayed in realtime. For details refer to: [p.221 — RealBathy™ depth contours](#)
- **SonarChart™ Live** — In the chart app, when using compatible Navionics charts, the SonarChart™ Live feature logs vessel depth and position to enable creation of personalized depth contours that can be displayed in realtime. For details refer to: [p.222 — SonarChart™ Live](#)
- **Data logging** — When the MFD is configured using the *First Responder* profile, vessel depth, vessel position, active MoB, and details of nearby AIS targets are logged to a CSV file and saved to a memory card. For details refer to: [p.364 — Data logging](#)
- **Sonar recording** — The sonar recording feature is for troubleshooting purposes only, and records the fishfinder app's scrolling image to a video file for analysis by Raymarine technical support. For details refer to: [p.525 — Diagnostics sonar recording](#)

All of the recording/logging features can be enabled and disabled as desired; for instructions, refer to the links provided above.

CHAPTER 5: GETTING STARTED

CHAPTER CONTENTS

- 5.1 Switch on / off — page 58
- 5.2 Controls — page 59
- 5.3 Initial setup — page 63
- 5.4 Calibration — page 71
- 5.5 Shortcuts menu — page 79
- 5.6 Device pairing — page 82
- 5.7 Networking constraints — page 83
- 5.8 Internet connection — page 84

5.1 Switch on / off

Axiom® and Axiom® 2 displays with a power swipe

Switching on the display

When the display is powered but in standby, the [Power swipe] touch control will be illuminated.

To switch on the display:

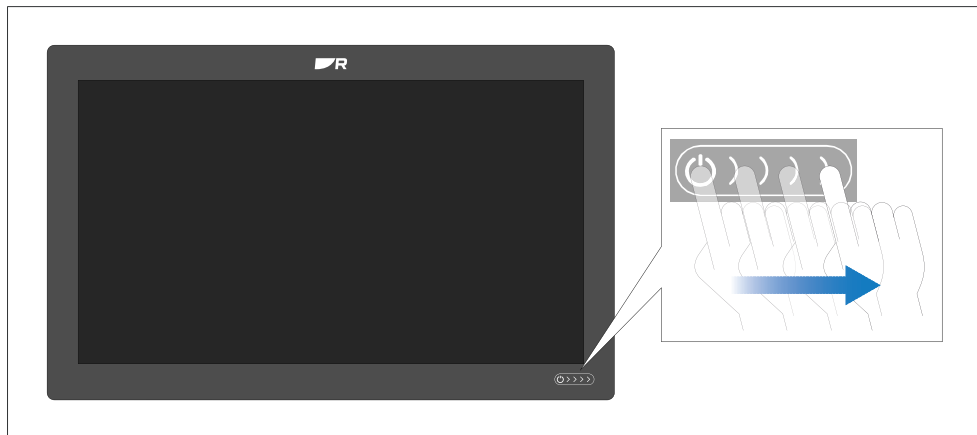

1. Swipe your finger from left to right across the [Power swipe] touch control. The display will boot up.

Switching the display to standby

When the display is switched on follow the steps below to put the display into standby (switch off).

Display standby

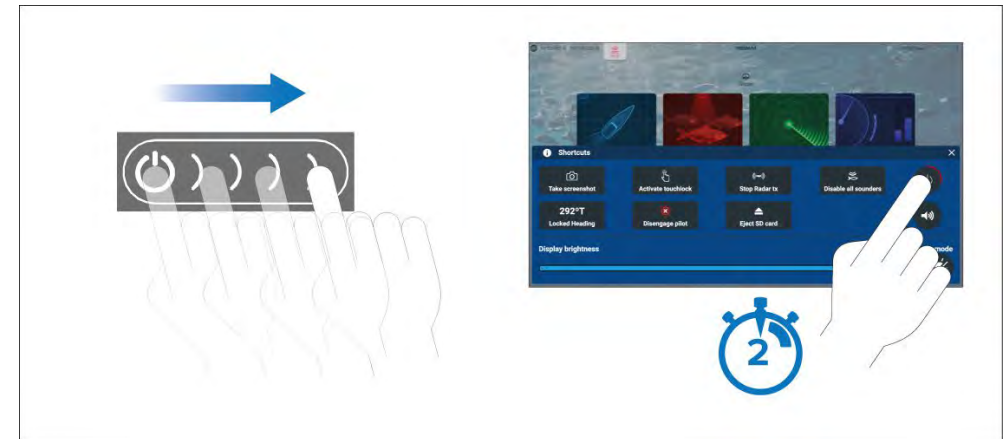

1. Swipe your finger from left to right across the power swipe touch control. The Shortcuts menu is displayed.
2. Press and hold the [Power symbol] until the screen switches off.

Note:

When in standby, the display may still draw a small amount of power from the battery. If this is a concern, unplug the power supply or switch off at the breaker.

Removing power

If you wish to ensure that the display is not consuming any power, then it must be switched off at the breaker or the power cable must be unplugged.

When the breaker is switched back on or the cable is reconnected, the display will resume in the same power state that it was in when it was switched off.

Axiom® and Axiom® 2 displays with a power button

Switching on the display

1. Press the power button to switch on the display. The display will boot up.

Switching the display to standby

When the display is switched on follow the steps below to put the display into standby (switch off).



1. Press the *[Power]* button.
The Shortcuts menu is displayed.
2. Press and hold the *[Power symbol]* until the screen switches off.

Alternatively, you can press and hold the *[Power]* button for approximately 6 seconds to put the display in standby.

Note:

When in standby, the display may still draw a small amount of power from the battery. If this is a concern, unplug the power supply or switch off at the breaker.

Removing power

If you wish to ensure that the display is not consuming any power, then it must be switched off at the breaker or the power cable must be unplugged.

When the breaker is switched back on or the cable is reconnected, the display will resume in the same power state that it was in when it was switched off.

5.2 Controls

Axiom®, Axiom® +, Axiom® XL and Axiom® 2 XL controls

Axiom®, Axiom® +, Axiom® XL and Axiom® 2 XL displays have a touchscreen and a touch control power swipe area.

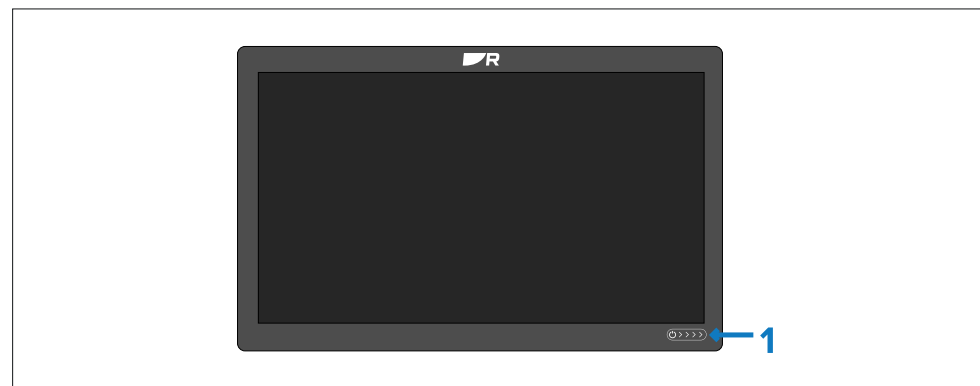

1. *[Power swipe area]* — Swipe your finger from left to right across the power swipe area to switch on the display. When switched on swipe again to open the shortcuts page.

Axiom® 2 Pro controls

Axiom® 2 Pro displays are controlled using both a touchscreen and physical buttons. The details below describe the buttons and their functions.

The display is supplied with the Pilot lower keypad fitted. The optional user-programmable lower keypad is also supplied in the box.

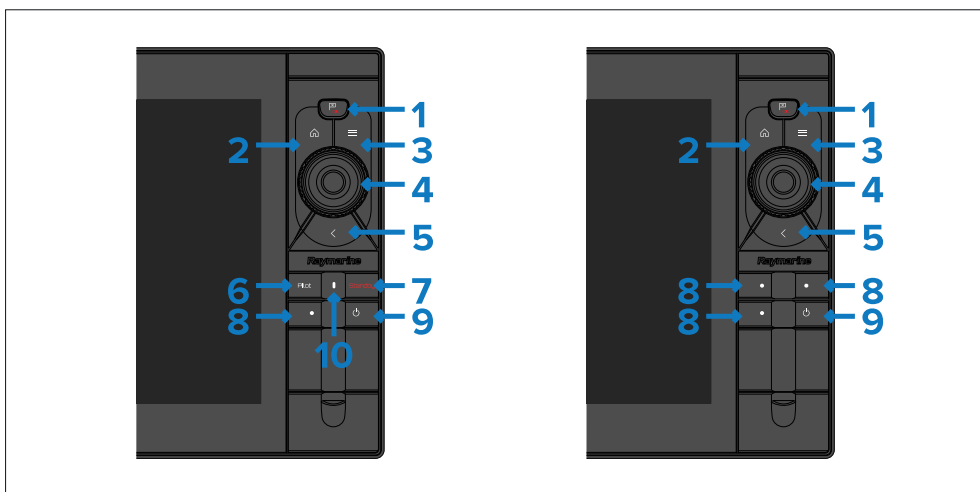

1. *[Waypoint / MOB]*— Press momentarily to place a waypoint at your vessel’s location. A long press activates the Man overboard (MOB) alarm.
2. *[Home]*— Press to show the Homescreen.
3. *[Menu]*— Press to open or close menus.
4. *[Uni-controller]*— The Uni-controller consists of a center *[OK]* button, *[Directional]* controls and a *[Rotary]* knob.
5. *[Back]*— Press to return to the previous menu or dialog.
6. *[Standby]*— Press to disengage active autopilot.
7. *[Pilot]*— Press momentarily to show or hide the Pilot sidebar. A long press engages the autopilot in locked heading mode.
8. *[User configurable keys]*— Press and hold each button to assign a function. Press the button to perform the assigned function.

Note: The default Pilot lower keypad has one user-configurable key. The user-configurable lower keypad has 3 configurable keys.

9. *[Power]*— Press to switch on the display. When the display is switched on, pressing this button opens the Shortcuts page.
10. *[Pilot status]*— LED providing pilot status. For details, refer to: [p.143 — Pilot keypad LED status \(Axiom® 2 Pro only\)](#)

Axiom® Pro controls

Axiom® Pro includes both a touchscreen and physical buttons that can be used to control the display. The details below describe the buttons and their functions.

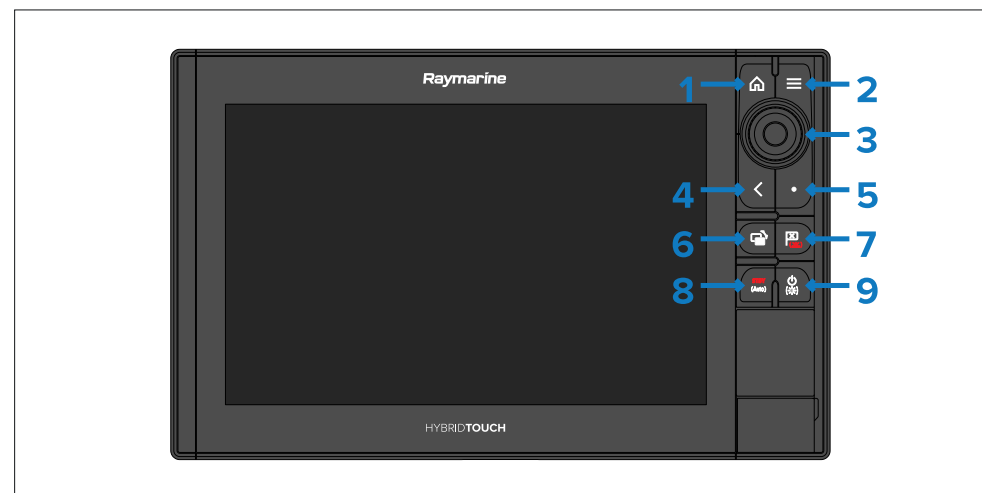

1. *[Home]*— Press to show the Homescreen.
2. *[Menu]*— Press to open or close menus.
3. *[Uni-controller]*— The Uni-controller consists of a center *[OK]* button, *[Directional]* controls and a *[Rotary]* knob.
4. *[Back]*— Press to return to the previous menu or dialog.
5. *[User configurable keys]*— Press and hold the button to assign a function. Press the button to perform the assigned function.
6. *[Switch active]*— Press momentarily to switch the active pane in a splitscreen page. A long press expands the selected pane.
7. *[Waypoint / MOB]*— Press momentarily to place a waypoint at your vessel’s location. A long press activates the Man overboard (MOB) alarm.
8. *[Pilot]*— Press momentarily to show or hide the Pilot sidebar. A long press engages the autopilot in locked heading mode, or disengages an active autopilot.
9. *[Power]*— Press to switch on the display. When the display is switched on, pressing this button opens the Shortcuts page.

Uni-controller

The Uni-controller functions as detailed below.

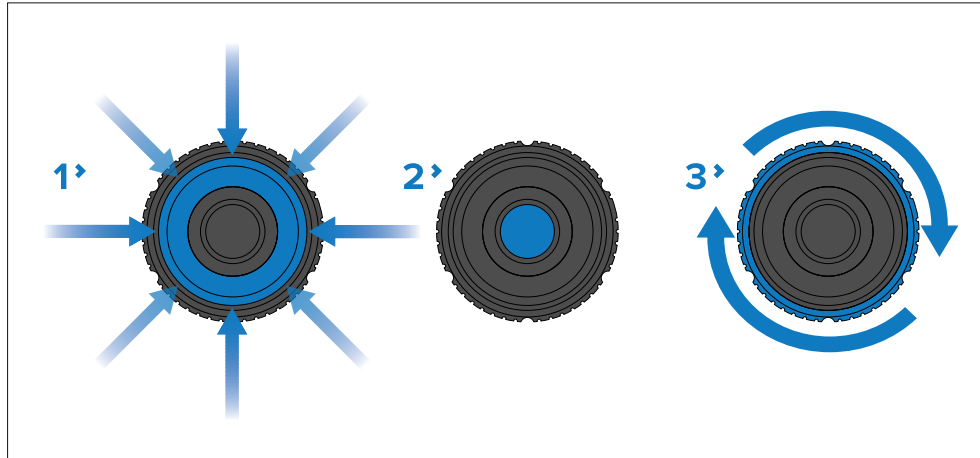

1. *[Directional]*— Use the 8-way directional controls to reposition the cursor onscreen.
2. *[OK]*— Push the button to confirm a selection.
3. *[Rotary]*— Turn clockwise to Range or Zoom In and counterclockwise to Range or Zoom out.

RMK controls

Displays can be controlled remotely using an RMK-9 or RMK-10.

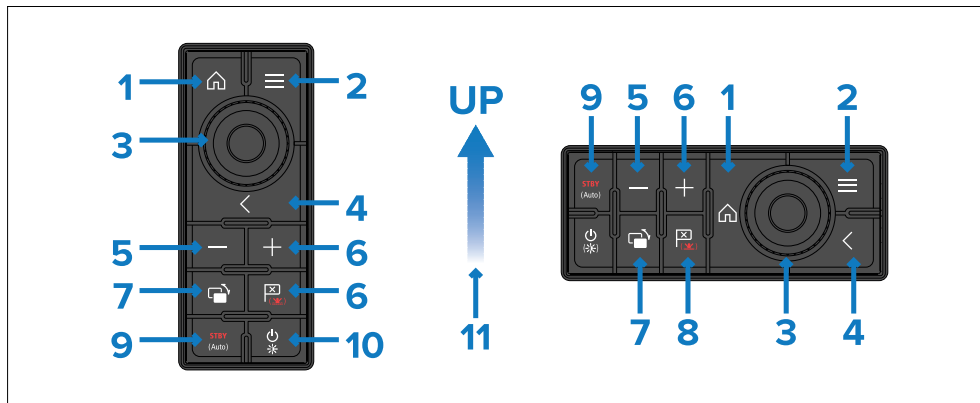

1. *[Home]*— press to return to the Homescreen.

Getting started

2. *[Menu]*— press to access menus. Press again to close menus.
3. *[UniController]*— provides a rotary control and a joystick that includes an *[OK]* push button for using menus and applications.
4. *[Back]*— press to return to a previous menu or dialog level.
5. *[-]* (Minus/Negative symbol) — press to range out.
6. *[+]* (Plus/Positive symbol) — press to range in.
7. *[Active]*— press to switch the active pane, or to switch the active display (in multiple display systems).
8. *[Waypoint / MOB]*— press and release to access the waypoint options. Press again to place a waypoint. Press and hold to place a Man Overboard (MOB) marker at your current position.
9. *[Standby (Auto)]*— press to disengage integrated autopilot, press and hold to activate Auto mode on integrated autopilot.
10. *[Power]*— see table below:

Configuration	Display State	Momentary press	Press and hold
Single display	Off	Not applicable	Not applicable
	On	Open Shortcuts page	Power off / put into Standby
Multiple displays	All displays Off	Not applicable	Not applicable
	All displays On	Open Shortcuts page on active display	Power down all displays
	1 display on and 1 display off	Open Shortcuts page on active display	Power down active display

Note: Displays that are switched off must be switched back on using the display's *[Power]* button.

11. Direction of Joystick Up.

iKey Bluetooth keyboard controls

The display is compatible with the iKey Bluetooth keyboard. When connected, the Bluetooth keyboard can be used to control the display.



In addition to typical alphanumeric keyboard functions, the keyboard provides a mapping of the display's physical buttons, as follows:

- *[F4]* — User Configurable Key (available on Axiom® Pro displays)
 - Press and hold — Choose action for button
- *[F6]* — Power/Shortcuts
 - Press and hold — shut down
- *[F7]* — Home
- *[F8]* — Event marker / Waypoint
- *[F9]* — Menu (App specific menu)
- *[F11]* — Switch Active
- *[F12]* — Pilot
- *[Esc]* — Back
- *[Enter]* — OK
- *[Up arrow]* — UniControl Up
- *[Down arrow]* — UniControl Down

- *[Left arrow]* — UniControl Left
- *[Right arrow]* — UniControl Right
- *[Trackpad]* — Touchscreen / UniControl directions
- *[Trackpad]* + *[Left trackpad button]* — Pan chart area (Chart app)
- *[Trackpad]* + *[Right trackpad button]* — Pan chart area (Chart app)
- *[Left trackpad button]* — Select / OK
 - Press and hold — long press (touchscreen)
- *[Right trackpad button]* — OK
 - Press and hold — long press (touchscreen)
- *[>]* — Increase display brightness (when Shortcuts page is displayed) / back sonar scroll-back bar in Fishfinder app
- *[<]* — Decrease display brightness (when Shortcuts page is displayed) / forward sonar scroll-back bar in Fishfinder app
- *[+]* — Range / Zoom In
- *[-]* — Range / Zoom Out
- *[Pg Up]* (*[Fn]* + *[Up arrow]*) — Range / Zoom In
- *[Pg Dn]* (*[Fn]* + *[Down arrow]*) — Range / Zoom Out

Connecting a Bluetooth keyboard

Follow the steps below to connect a Bluetooth keyboard to your display.

Note:

The steps below describe connecting the ikey Bluetooth keyboard. Other Bluetooth keyboards may be connected in a similar way, but Raymarine does not guarantee compatibility.

5.3 Initial setup

First power up

When you power up your new display for the first time a number of actions are required.

The list below shows the actions that should be performed on your new display:

1. *[Power]* on the display.
2. Select your datamaster (only required on networks with more than 1 display).
3. Complete the *[Startup wizard]* (the wizard will not be shown if you are connecting to an existing system that has already been set up).
4. Select keypad type (Axiom[®] 2 Pro displays only).
5. Read and agree to the *[Limitations on Use]* disclaimer.
6. Select/check your preferred *[Data sources]*, if required.
7. Perform *[Engine identification]*, if required.
8. Select/check *[Transducer settings]*, if required

First power up datamaster selection

Ethernet networks that contain more than 1 display must have a designated datamaster. The datamaster is the primary display on the network and should be the display that is also connected to the SeaTalkng[®] / NMEA 2000 network and any other sources of data in your system. The datamaster bridges the data over the ethernet network to any compatible networked 'repeater' displays.

By default your display will be set as a datamaster. If you connect a new display to the network then on first power up the 'Multiple datamasters found' notification will be displayed.

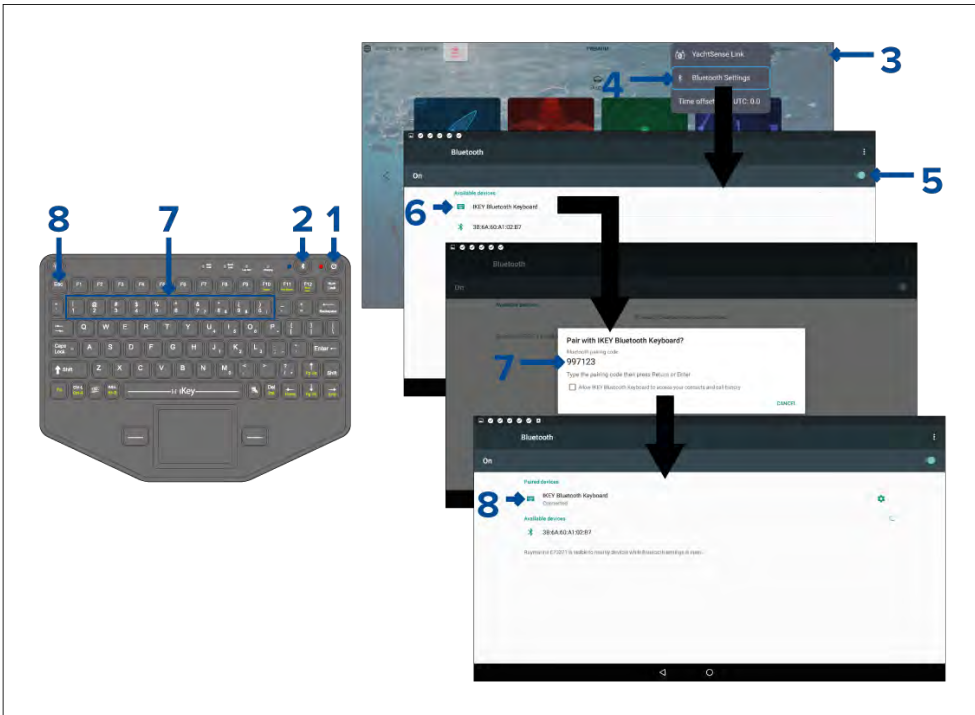

1. Press and hold the *[Power]* button for approximately 4 seconds, until the power button LED flashes red.
2. Press and release the *[Bluetooth]* button.
3. From the display, select the status area (top right of homescreen).
4. Select *[Bluetooth Settings]*.
5. Enable Bluetooth using the toggle switch.
6. Select the Bluetooth keyboard.
7. Using the keyboard, enter the Bluetooth pairing code displayed on the screen, and press *[Enter]*.
8. Once connected, press the *[Esc]* button on the keyboard to return to the homescreen.

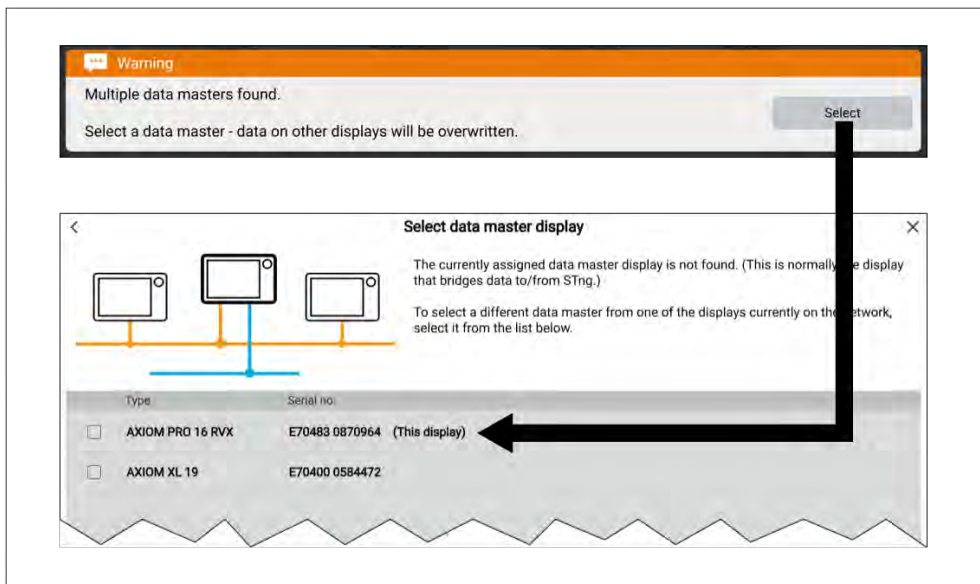

Select the button from the notification and choose your desired datamaster from the list.

Note:

If you are selecting a new datamaster then all networked displays' settings and any saved waypoints, routes and tracks will be overwritten with those of the new datamaster display. To prevent loss of data and settings perform a back up of data and settings on the current datamaster before assigning a new datamaster.

You can change your datamaster at anytime by selecting *[Assign as datamaster]* from the pop-over menu for the displays listed in the *[Network]* settings menu: *[Homescreen > Settings > Network]*.

Startup wizard

The first time the display is switched on the Startup wizard will be displayed. If an existing display is chosen as the datamaster then the start up wizard will be skipped. The Startup wizard will help you configure important settings on your display.

Follow the onscreen instructions and configure the relevant settings.

The Startup wizard will also be displayed after a *[Factory reset]* is performed.

The wizard will guide you through:

- Language selection
- Boating activity selection
- Boat details configuration

Languages

The following user interface languages are available:

Arabic (ar-AE)	Bulgarian (bg-BG)	Chinese (Simplified) (zh-CN)	Chinese (Traditional) (zh-TW)
Croatian (hr-HR)	Czech (cs-CZ)	Danish (da-DK)	Dutch (nl-NL)
English (en-GB)	English (en-US)	Estonian (et-EE)	Finnish (fi-FI)
French (fr-FR)	German (de-DE)	Greek (el-GR)	Hebrew (he-IL)
Hungarian (hu-HU)	Icelandic (is-IS)	Indonesian (Bahasa) (id-ID)	Italian (it-IT)
Japanese (ja-JP)	Korean (ko-KR)	Latvian (lv-LV)	Lithuanian (lt-LT)
Malay (Bahasa) (ms-MY ZSM)	Norwegian (nb-NO)	Polish (pl-PL)	Portuguese (Brazilian) (pt-BR)
Russian (ru-RU)	Slovenian (sl-SI)	Spanish (es-ES)	Swedish (sv-SE)
Thai (th-TH)	Turkish (tr-TR)	Vietnamese (vi-VN)	

The selected language also determines the display's default units of measure.

Boating activities

During the start up wizard the boating activity must be selected. The selected boating activity will pre-configure the display using applicable settings. Some of these settings may not be available to other boating activities.

One of the following boating activities can be selected:

- *[Fishing (freshwater)]*
- *[Fishing (saltwater)]*
- *[Motor cruising]*
- *[First responder]*
- *[Sailing]*
- *[Other]*

- *[Retail/demonstration]*

Boat details

During the start up wizard you will be requested to enter the details listed below for your boat. You can also add or changes these details at anytime from the *[Boat details]* settings menu: *[Homescreen > Settings > Boat details]*.

Safety clearances

- Minimum safe depth
- Minimum safe height
- Minimum safe width

For details and guidance on how to set safety clearances refer to: [p.65 – Safety clearances](#)

Engines

- Number of engines
- Engine manufacturer

Tanks

- Number of fuel tanks
- Number of fuel (gasoline) tanks
- Number of fresh water tanks
- Number of live well tanks
- Number of gray water tanks
- Number of black water tanks

Axiom® 2 Pro keypad type selection

After the startup wizard is completed on Axiom® 2 Pro displays, or following the selection of a different display as datamaster, the keypad type selection screen is displayed.

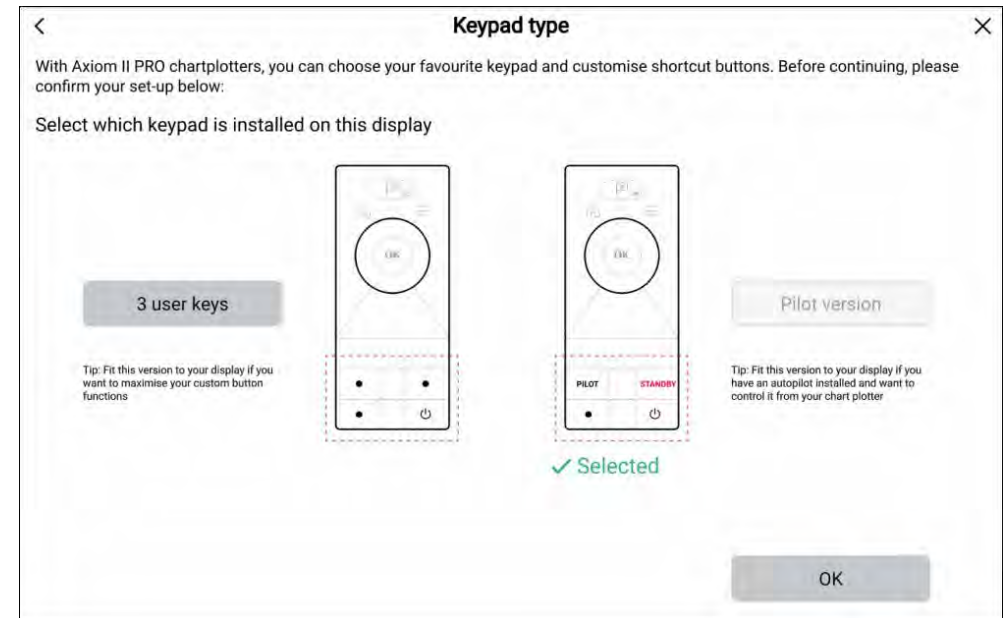

By default Axiom® 2 Pro displays are fitted with the *Pilot Version* lower keypad. If you intend to keep the *Pilot Version* lower keypad, select the *[Pilot version]* button and then select *[OK]*.

If you have installed or intend to install the *3 User Keys* lower keypad, select the *[3 user keys]* button and then select *[OK]*.

The keypad selection can be changed at any time from the *[This display]* settings menu: *[Homescreen > Settings > This display > Keypad type:]*.

Safety clearances

Minimum safe depth

During the start up wizard you can set a minimum safe depth for your vessel. The minimum safe depth can also be added or changed at anytime from the *[Boat details]* setting menu: *[Homescreen > Settings > Boat details]*.

A suitable value for minimum safe depth can be established by identifying your vessel's maximum draft and adding a safety margin.

- **Maximum vessel draft** — the distance from the waterline to the lowest point of your vessel's hull/keel.
- **Safety margin** — an adequate clearance below the hull/keel to allow for draft variation and changes in water or bottom conditions.

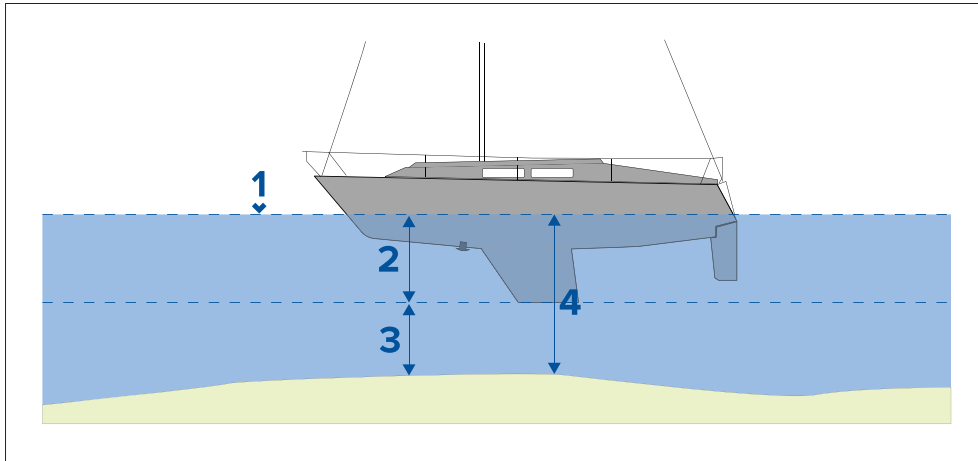

1. Waterline
2. Maximum vessel draft
3. Safety margin
4. *[Minimum safe depth]*

Minimum safe depth calculation guidance

The information below is provided for guidance only and is not exhaustive. Some influencing factors can be unique to certain vessels and/or areas of water and may not be listed below. You should ensure you account for ALL factors that apply to your current situation when making calculations.

Some of the factors that can influence how much a vessel draws are shown below:

- **Vessel displacement (weight)** — A vessel's draft will increase when it is fully laden when compared with its unladen displacement.
- **Water type** — A vessel's draft will increase by approximately 2% to 3% in fresh water compared to seawater.

Some of the factors that should be taken into account when calculating a safety margin are:

- **Vessel maneuvering characteristics** — A vessel's draft increases due to squat, trim, roll, pitch and heave.

- **Chart accuracy** — The electronic chart depth may not be accurate or the true depth may have changed since the last survey.
- **Weather conditions** — High air pressure, and prevailing wind strength and direction can affect wave height.

Minimum safe height

During the start up wizard you can set a minimum safe height for your vessel. The minimum safe height can also be added or changed at anytime from the *[Boat details]* setting menu: *[Homescreen > Settings > Boat details]*.

A suitable value for minimum safe height can be established by identifying your vessel's maximum height from the waterline and adding a safety margin.

- **Maximum vessel height** — the distance from the waterline to the highest point of your vessel e.g.: top of the mast.
- **Safety margin** — an adequate clearance above your mast to allow for height variation.

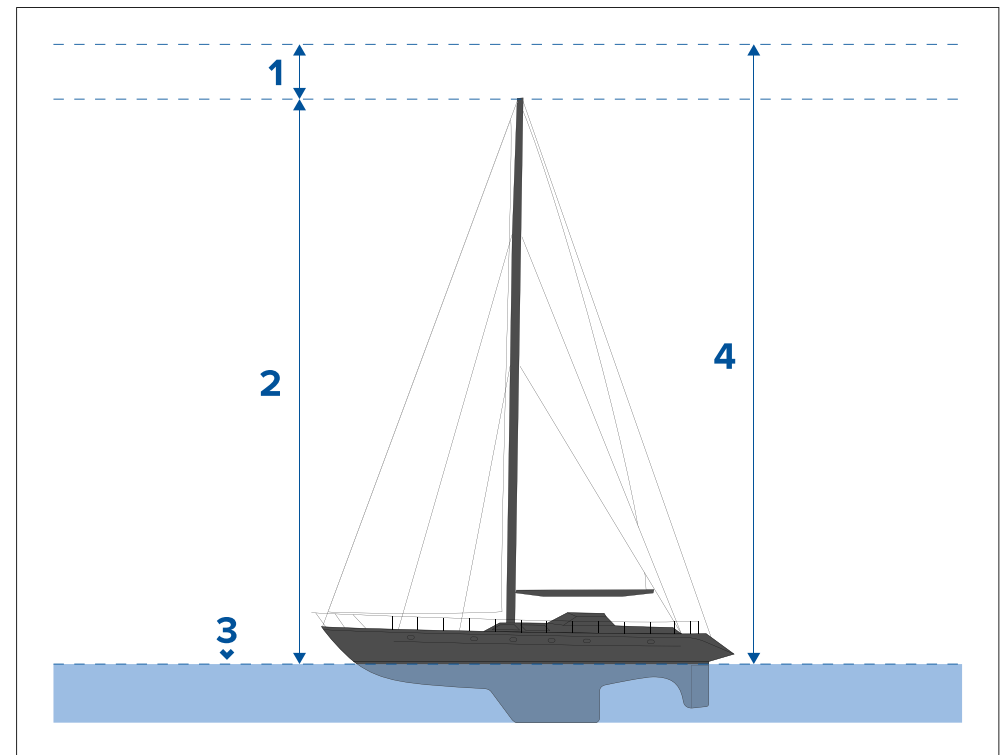

1. Safety margin

2. Maximum height from waterline
3. Waterline
4. *[Minimum safe height]*

Minimum safe height calculation guidance

The information below is provided for guidance only and is not exhaustive. Some influencing factors can be unique to certain vessels and / or areas of water and may not be listed below. You should ensure you account for ALL factors that apply to your current situation when making calculations.

Some of the factors that can influence vessel height are shown below:

- **Vessel displacement (weight)** — A vessel's height (from the waterline) will decrease when it is fully laden compared with its unladen displacement.
- **Water type** — A vessel's height will decrease by approximately 2% to 3% in fresh water compared to seawater.

Some of the factors that should be taken into account when calculating a safety margin are:

- **Vessel maneuvering characteristics** — A vessel's height changes due to squat, trim, roll, pitch and heave.
- **Chart accuracy** — The electronic chart data may not be accurate or may have changed since the last survey.
- **Weather conditions** — Low air pressure, and prevailing wind strength and direction can affect water level.

Minimum safe width

During the start up wizard you can set a minimum safe width for your vessel. The minimum safe width can also be added or changed at anytime from the *[Boat details]* setting menu: *[Homescreen > Settings > Boat details]*.

A suitable value for minimum safe width can be established by identifying your vessel's maximum width and adding a safety margin to each side.

- **Maximum width** — Taken from the widest point.
- **Safety margin** — An adequate clearance to either side of the vessel.)

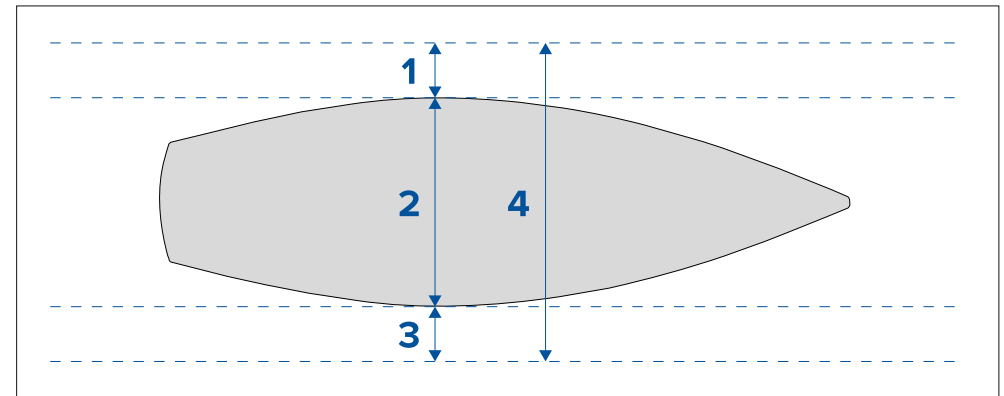

1. Port safety margin
2. Maximum vessel width (beam)
3. Starboard safety margin
4. *[Minimum safe width]*

Minimum safe width calculation guidance

The information below is provided for guidance only and is not exhaustive. Some influencing factors can be unique to certain vessels and / or areas of water and may not be listed below. You should ensure you account for ALL factors that apply to your current situation when making calculations.

Some of the factors that should be taken into account when calculating a Safety Margin are:

- **Vessel maneuvering characteristics** — A vessel's required clearance will increase due to roll.
- **Chart accuracy** — The electronic chart data may not be accurate or may have changed since last surveyed.

First power up limitation on use acknowledgement

After you have completed the startup wizard the Limitation on Use (LoU) disclaimer is displayed.

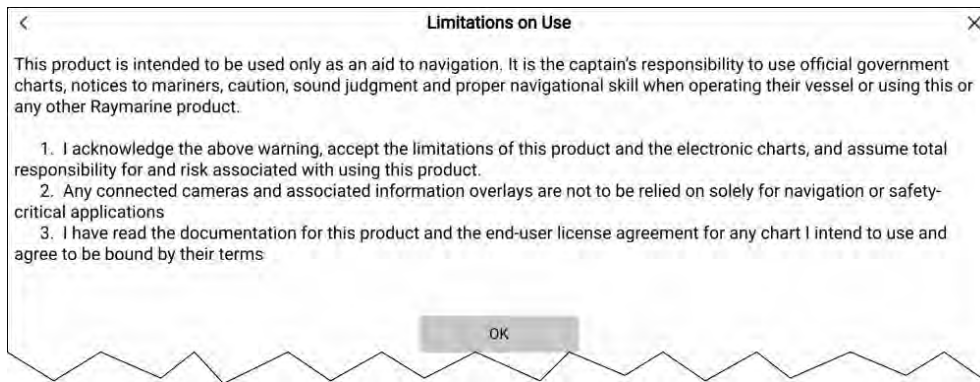

You must read and agree to the disclaimer in order to use your MFD.

Selecting *[OK]* means you have agreed to the terms of the disclaimer.

Engine manufacturer selection

Engine data from engine management systems that transmit compatible data or that are connected via a compatible engine gateway can be displayed on the MFD. During the start up wizard you can select your engine manufacturer. Engine manufacturer can also be selected or changed at anytime from the *[Boat details]* setting menu: *[Homescreen > Settings > Boat details]*.

You can select one of the following engine manufacturers:

- *[Mercury]* — Selecting Mercury will make the Mercury VesselView MFD app available on the MFD.
- *[Yamaha]* — Selecting Yamaha will make the Yamaha MFD app available on the MFD.
- *[Yamaha HDMI]* — Selecting Yamaha HDMI will make the Yamaha HDMI MFD app available on the MFD.
- *[Other]* — Selecting other will enable engine data from compatible engines that are either directly connected or connected via the ECI-100 available on the MFD.

Identifying engines

If your MFD has mislabelled your engines this can be corrected by running the engine identification wizard.

When the engine manufacturer is set to *[Other]* the engine identification wizard will be enabled in the *[Boat details]* menu: *[Homescreen > Settings > Boat details > Identify engines]*.

1. Ensure the correct number of engines is selected in the *[Num of Engines:]* box.
2. Select *[Identify engines]*.
3. Follow the onscreen prompts to complete the engine identification wizard.

Multiple data sources (MDS)

MDS is a Raymarine scheme for managing multiple sources of identical data types on the same network (e.g.: in an MFD network you may have more than one source of GNSS (GPS) position data).

The MFD will automatically select a preferred data source (device) to use for that data type.

MDS can be used for the following data types:

- *Depth*
- *Speed through water*
- *Heading*
- *GPS*
- *GPS Datum*
- *Wind*
- *Time & Date*

If you do not want to use the automatically selected data source you can manually select your preferred data source.

Note:

For MDS to be available on your system, all products in the system that report data must be MDS-compliant. The system will report any products that are NOT MDS-compliant. It may be possible to upgrade the software for these non-compliant products, to make them compliant. Visit the Raymarine website to obtain the latest software for your products: <https://www.raymarine.com/software>

If MDS-compliant software is not available for the product and you do NOT want to use the system's preferred data source, you must remove any non-compliant products from the system. You should then be able to select your preferred data source.

Once you have completed setting up your preferred data sources, you may be able to add non-compliant products back into the system.

Data sources menu

When a system includes multiple sources of an MDS compatible data type the system will automatically choose the most appropriate source for the data. If you prefer, you can manually select your own data source.

The *[Data sources]* menu can be accessed on your datamaster MFD, from the *[Settings]* menu: *[Homescreen > Settings > Network > Data sources]*.

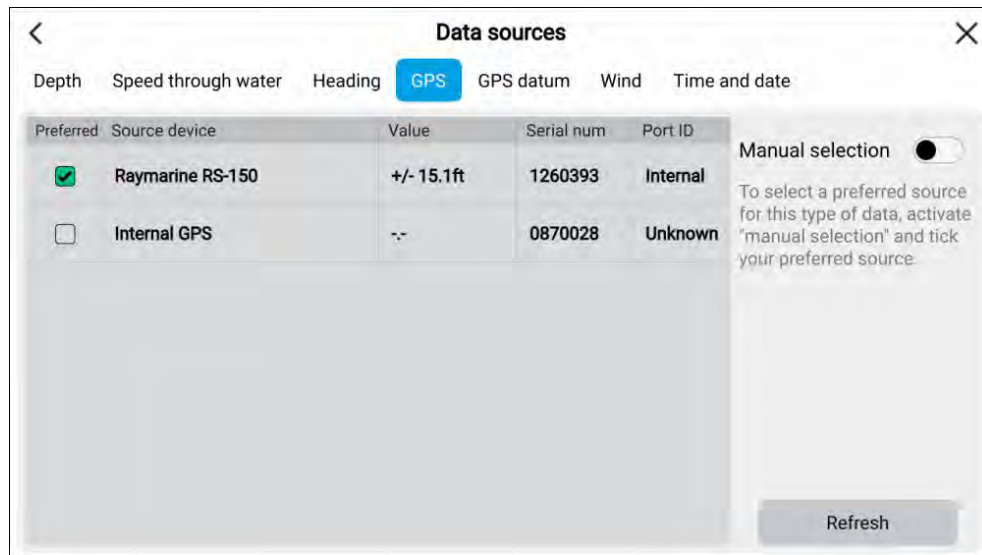

Each menu tab enables you to view the available data sources and, if required, manually select your preferred data source. The currently active data source will be ticked and display its current value in use.

To manually select a data source, enable the *[Manual selection]* toggle switch and then select your preferred data source from the list.

Networked MFDs will automatically be updated to use the Data sources selected on your datamaster MFD.

Select the *[Refresh]* button at the bottom of the screen to refresh the list.

Battery configuration

The MFD will automatically detect the number of batteries in your system when the information is transmitted using standard NMEA 2000 PGNs 127506 & 127508, or via other supported systems. Detected batteries can be viewed and customized from the battery configuration table.

The battery configuration table can be accessed from the *[Boat details]* settings menu: *[Homescreen > Settings > Boat details > Configure batteries]*.

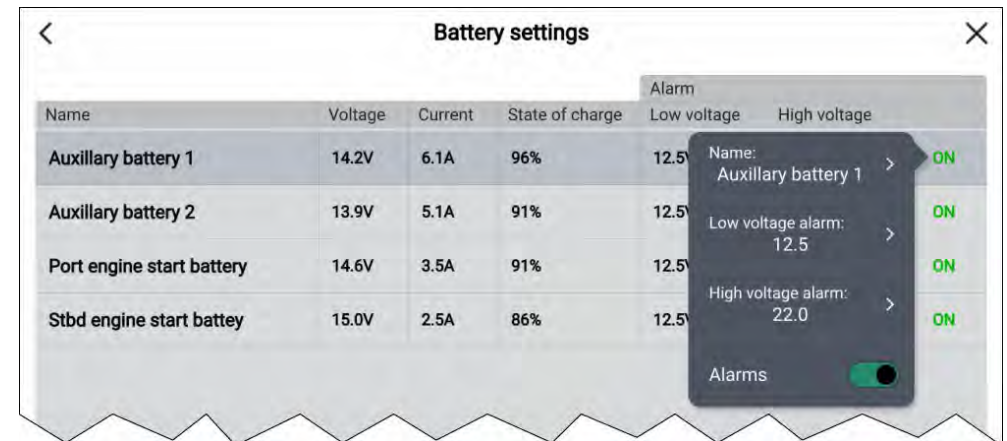

The battery configuration table lists all detected batteries and provide details and status for each. Default battery names are based on device name plus battery number (instance).

Selecting a battery from the table displays a pop-over menu where you can rename or set up a low and high voltage alarm for the selected battery. Changed battery names will appear in battery data items for sidebars, Dashboard app and app data overlays.

The battery configuration table can also be accessed from the alarms settings: *[Homescreen > Alarms > Settings > Configure batteries]*.

Assigning a function to the User Configurable key

You can assign a function to the User Configurable keys on Axiom® Pro and Axiom® 2 Pro displays.

- Axiom® Pro displays have one User Configurable key.
- Axiom® 2 Pro displays configured using the *Pilot Version* lower keypad also have one User Configurable key.
- Axiom® 2 Pro displays configured using the *3 User Keys* lower keypad have 3 User Configurable keys.

1. Press and hold the physical *[User Configurable key]*.

You can choose one of the following options for each key:

- *Show/hide Sidebar*
- *Start/stop track*
- *Restart XTE*
- *Touchlock On/Off*
- *Take screenshot*
- *Show/hide AIS vectors*
- *Switch active pane*

2. Select the required function from the list.

You can also assign a function to the *[User configurable key]* from the Settings menu: *[Homescreen > Settings > This Display > User configurable key]*.

On Axiom® 2 Pro displays with the *3 User Keys* lower keypad fitted, you must select *[3 user keys]* instead of *[Pilot version]* as the *[Keypad type]*.

Performing a settings reset

Performing a settings reset will reset your display's settings to their original configuration no data (e.g.: waypoint, routes etc.) will be lost when performing a settings reset.

From the Homescreen:

1. Select *[Settings]*.
2. Select *[This display]*.
3. Scroll to the bottom of the *[This display]* menu.

4. Select *[Settings reset]*.

5. Select *[Yes]*.

The display will reboot and any settings that have been changed will be reset to their original default values.

Performing a factory reset

Performing a factory reset will reset your display to its original factory condition.

Important:

Performing a factory reset will erase all user data (i.e.: waypoint, route and tracks) and reset any changes to the display's settings. If you want to backup your user data and settings refer to: [p.106 – Import/export](#)

From the Homescreen:

1. Select *[Settings]*.

2. Select *[This display]*.

3. Scroll to the bottom of the *[This display]* menu.

4. Select *[Factory reset]*.

5. Select *[Yes]*.

The display will reboot and the start up wizard will be displayed.

Importing user data

You can import user data (i.e.: Waypoints, Routes and Tracks) to your MFD.

1. Insert the MicroSD card that contains your user data files into a card reader slot on your MFD or connected card reader.

2. Select *[Import from card]* from the Import/export page: *([Homescreen > My data > Import/export > Import from card])*.

3. Select the relevant SD card slot from the file browser and then navigate to your User data file (.gpx).

4. Select the relevant GPX file.

Your user data has now been imported.

5. Select *[OK]*.

5.4 Calibration

Calibration sources

Compatible transducers and sensors can be calibrated from the display:

The following transducers and sensors can be calibrated:

- Sonar (fishfinder) transducers can be calibrated via the Fishfinder app.
- ITC-5 (speed, water temp, wind, compass, rudder, depth)
- DST810 (Speed)
- Smart wind vane (configuration)
- AR-200 (heading) via the Video app.

Sonar transducer calibration

Sonar transducers should be calibrated to ensure accurate readings are displayed on the MFD.

Depth offset

Depths are measured from the transducer face to the bottom (e.g.: seabed). An offset value can be applied to the depth data so that the displayed depth reading represents the depth reading taken from either the keel (negative offset) or the waterline (positive offset).

Before setting a waterline or keel offset, establish the vertical distance between the transducer and waterline or the bottom of your vessel's keel, as appropriate. Then set this distance as the depth offset value.

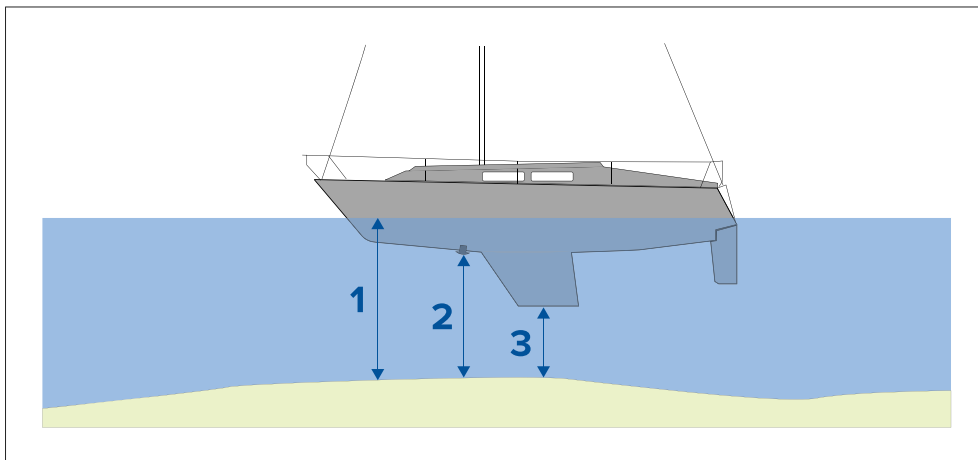

1. *[Below waterline]*— The depth reading will be increased from the transducer's default reading.
2. *[Below transducer]*— This is the default reading from the transducer (zero offset applied).
3. *[Below keel]*— The depth reading will be decreased from the transducer's default reading.

Setting a depth offset

You can set the point depth readings are taken from.

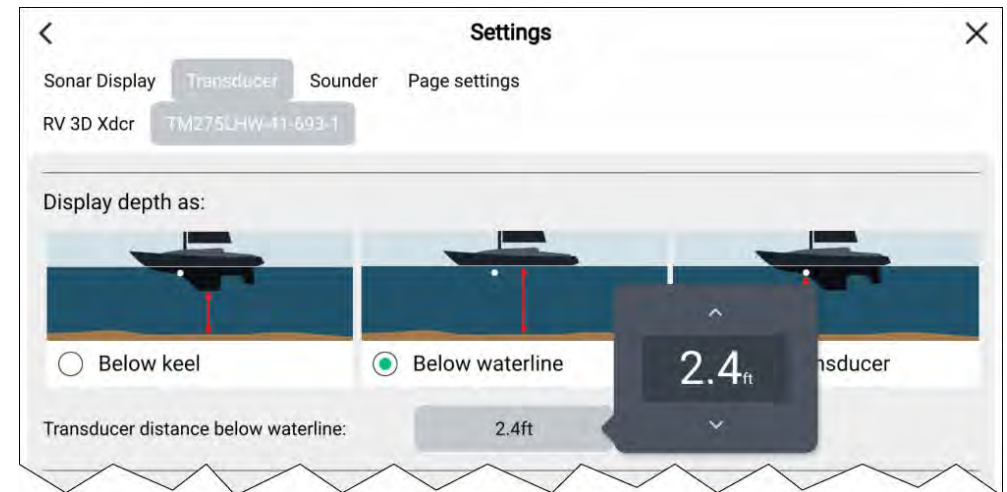

1. Open the *[Fishfinder app]*.
2. Open the *[Transducer]* settings menu: *[Menu > Settings Transducer]*.
3. If you have more than 1 sonar transducer installed, then you will need to select the relevant transducer.
4. Select either *[Below keel]*, *[Below waterline]*, or *[Below transducer]* as required.
 - i. If you have selected *[Below keel]* enter your transducer's distance above the lowest point of your keel in the offset field.
 - ii. If you have selected *[Below waterline]* enter your transducer's distance below the waterline in the offset field.

Setting a temperature offset

If your sonar transducer includes a temperature sensor then you can check and calibrate your temperature reading.



1. Open the *[Fishfinder app]*.
2. Open the *[Transducer]* settings menu: *[Menu > Settings Transducer]*.
3. If you have more than 1 sonar transducer installed, then you will need to select the relevant transducer.
4. If required, select the *[Enable temperature sensor]* toggle switch to enable the sensor.
5. Measure the actual water temperature using a thermometer.
6. Check your reading against the displayed *[Current temperature]*.
7. If the readings are not the same, select *[Calibrate temp]* and enter the difference between your 2 readings.

RealVision™ AHRS calibration

RealVision™ 3D and RealVision™ 3D Max transducers include a built-in AHRS (Attitude and Heading Reference Sensor), which measures the motion of your vessel to assist in the rendering of sonar images. After installation all RealVision™ transducers require calibration.

An uncalibrated transducer can produce an offset to the front edge of the render of the bottom in the sonar image, as illustrated below.

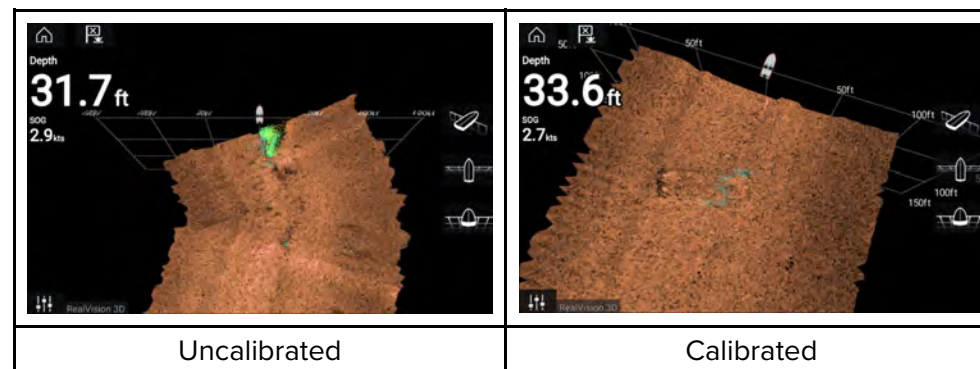

Calibration is an automatic process and starts after your vessel has turned approximately 100° at a speed of between 3 –15 knots. Calibration requires no user input, however at least a 270° turn is required before the calibration process can determine the local deviation and apply a relevant offset.

The time it takes to complete the calibration process will vary according to the characteristics of the vessel, the installation environment of the transducer, and the levels of magnetic interference at the time of conducting the process. Sources of significant magnetic interference may increase the time required to complete the calibration process. Certain areas with substantial magnetic deviation may require extra circles or “figure of 8” manoeuvres to be performed. Examples of such sources of magnetic interference include:

- Vessel engines
- Vessel alternators
- Marine pontoons
- Metal-hulled vessels
- Underwater cables

Note:

In some circumstances, it is beneficial to disable RealVision AHRS if local sources of magnetic interference are distorting the sonar image. RealVision AHRS can be disabled from *[Settings]*.

[Menu > Settings > Sounder > AHRS stabilization]

Note:

The Calibration process will require repeating after a *[Sonar reset]* or *[Factory reset]*.

Transducer calibration (iTC-5)

You can calibrate depth, speed and wind instrument transducers connected to your Lighthouse MFD via an iTC-5 (Instrument Transducer Converter).

Note:

Transducer calibration requirements:

- An iTC-5 Instrument Transducer Converter.
- An MFD designated as the datamaster.
- LightHouse version 3.11 or later or LightHouse version 4.0 or later.

Note:

You can only calibrate transducers that are directly connected to the iTC-5 you select for calibration. In systems with more than one iTC-5, it is important to remember which transducer(s) are connected to each iTC-5.

Selecting a transducer iTC-5

To calibrate instrument transducers, find the relevant iTC-5 from the list of devices connected to your MFD's network.

1. Select the *[Network]* settings tab

[Homescreen > Settings > Network]

2. Find and select the iTC-5 that the transducer you want to calibrate is connected to.

3. Select *[Calibrate]* from the pop-over menu..

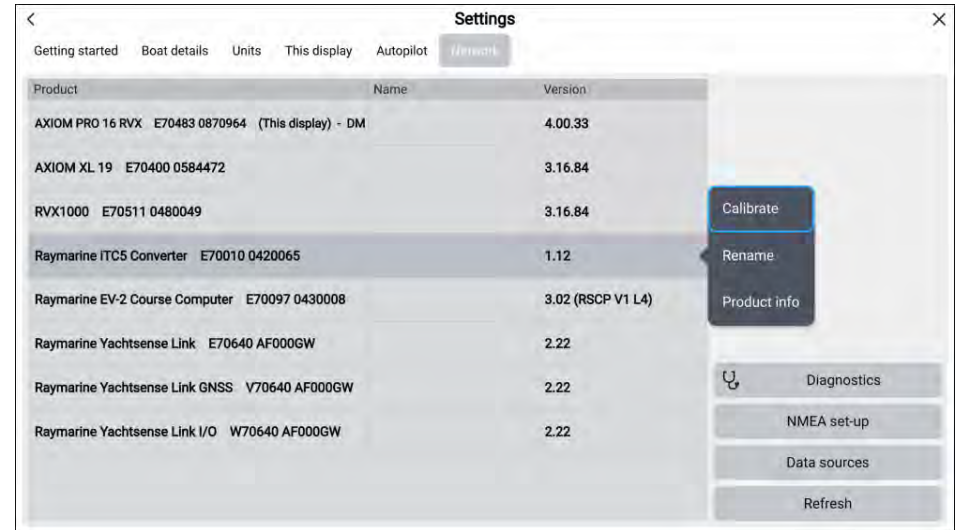

4. Select the transducer type (either *[Depth]*, *[Wind]* or *[Speed]*).

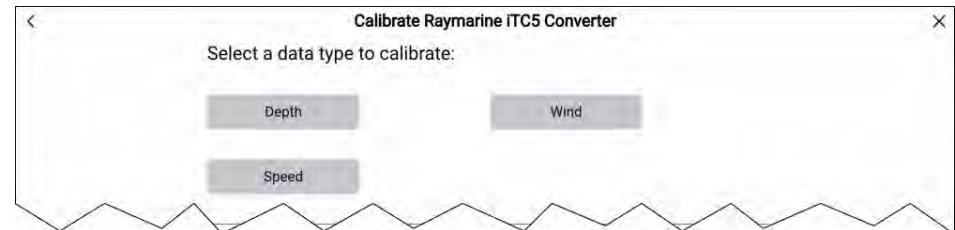

Instrument depth calibration

Calibrate your instrument depth transducer as follows.

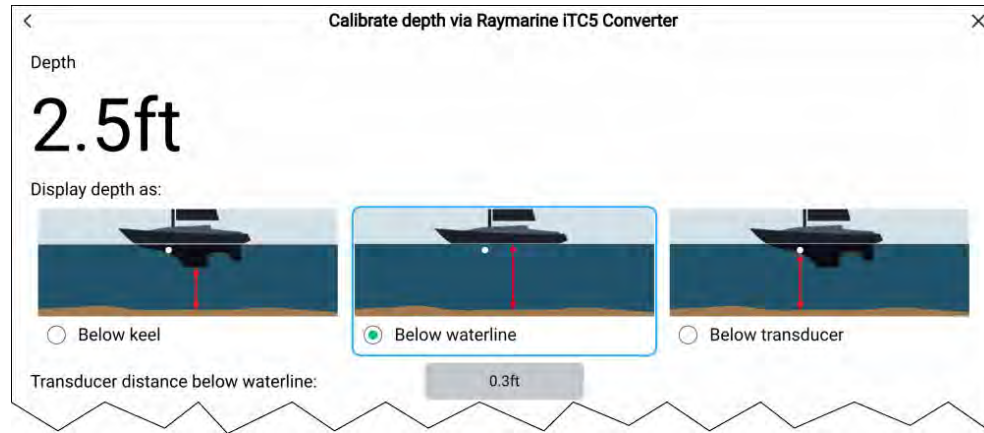

Select either:

- *[Below keel]*— The depth reading will be decreased from the transducer's default reading by the offset value you specify. The offset should be the distance between the transducer and the bottom of the keel.
- *[Below waterline]*— The depth reading will be increased from the transducer's default reading by the offset value you specify. The offset should be the distance between the waterline and the transducer.
- *[Below transducer]*— This is the transducer's default reading no offset is required.

Wind calibration

Calibrate your wind transducer as follows:

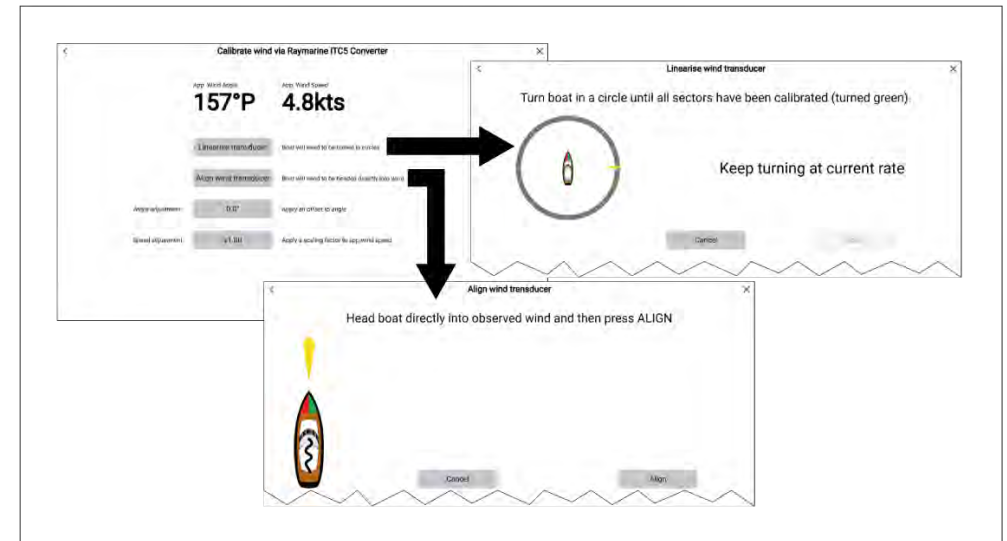

- *[Linearise transducer]*— Turn your boat in circles until all sectors have been calibrated (the ring turns green as sectors complete).
- *[Align wind transducer]*— Head your boat directly into observed wind and select *[Align]*.
- *[Angle adjustment]*— You can apply a specified offset to wind angle readings.
- *[Speed adjustment]*— You add a scaling factor to apparent wind speed.

Speed calibration

Calibrate your speed transducer as follows:

For best results, ensure that there is minimal or no tide/current effect when calibrating speed through water.

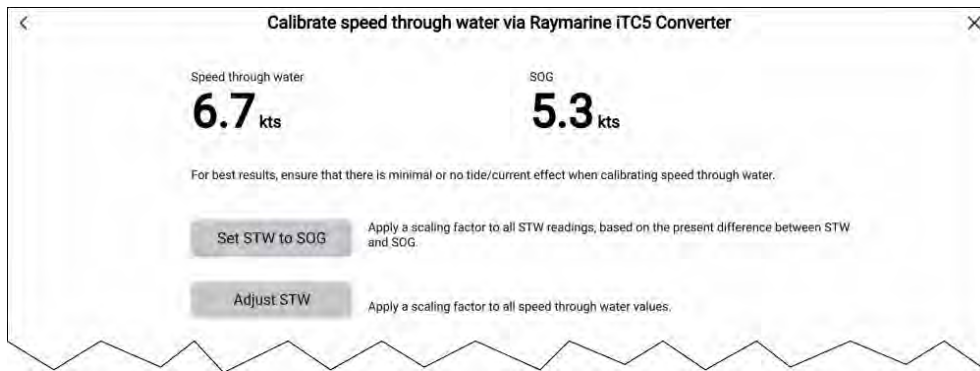

- *[Set STW to SOG]*— Select to apply a scaling factor to all STW readings, based on the present difference between STW and SOG.
- *[Adjust STW]*— Apply a scaling factor to all speed through water values.

STW calibration (DST810)

STW (Speed Through Water) can be calibrated on DST810 transducers, by performing a sea trial calibration.

Note:

Before calibration can be performed you must use the Airmar app to enable the Attitude PGN 127257.

The calibration settings can be accessed by selecting the DST810 transducer from the Network list [*Homescreen > Settings > Network > DST810*] and selecting [*Calibrate*] from the pop-over options; then select the [*Speed*] button to display the calibration options.

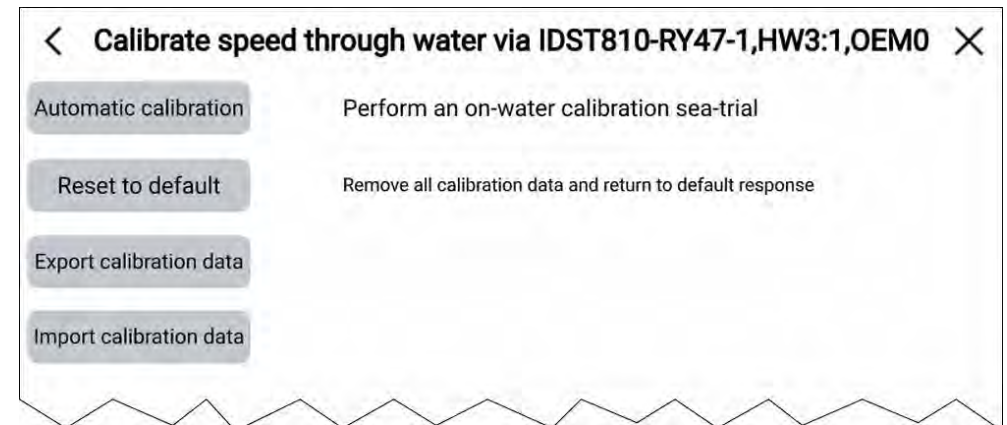

The following options are available for the DST810 transducer:

- *[Automatic calibration]*— Perform an on-water calibration sea trial.
- *[Reset to default]*— Remove automatic calibration data and return to default response.
- *[Export calibration data]*— Save the current calibration data to a memory card.
- *[Import calibration data]*— Restore calibration data previously saved to a memory card.

Performing STW calibration — Power boats

Calibration of STW on a DST810 transducer requires an on water sea trial.

< Automatic STW calibration for IDST810-RY47-1,HW3:1,OEM0 ✕



When calibration starts, drive the boat in a square-shaped route (2 minutes per side).

For best results, avoid strong or variable currents.

Repeat the square route for each speed setting you wish to calibrate, only saving the recording when you have completed all required speeds.

You can cancel and re-try the recording process any time.

Start calibration

For best results avoid strong or variable currents.

From the Speed calibration options menu:

1. Select *[Automatic calibration]* from the speed calibration menu.
2. Select *[Start calibration]*.

The Recording calibration notification is displayed. If calibration has already been performed you will be prompted to overwrite the calibration data.

3. Drive the boat in a square shaped route for 2 minutes on each side.
4. Repeat the square for each speed point you want to calibrate.
5. Select the *[Finished]* button.

You can *[Pause]*/*[Resume]* the calibration using the relevant buttons.

You can cancel the calibration at anytime by selecting the *[Cancel]* button.

Performing STW calibration — Sailing boats

Calibration of STW on a DST810 transducer requires an on water sea trial.

< Automatic STW calibration for IDST810-RY47-1,HW3:1,OEM0 ✕

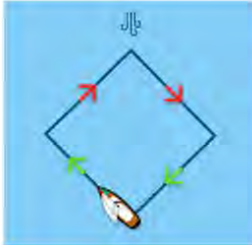

When calibration starts, sail the boat close-hauled upwind for 2 minutes. Then tack and sail upwind for a further 2 minutes.

Next, bear away and sail downwind for 2 minutes, then gybe and sail for a final 2 minute leg.

For best results, avoid strong or variable currents.

You can cancel and re-try the recording process any time.

Start calibration

For best results avoid strong or variable currents.

From the Speed calibration options menu:

1. Select *[Automatic calibration]* from the speed calibration menu.
2. Select *[Start calibration]*.

The Recording calibration notification is displayed. If calibration has already been performed you will be prompted to overwrite the calibration data.

3. Sail the boat close hauled upwind for 2 minutes.
4. Tack and Sail upwind for 2 minutes.
5. Bear away and sail downwind for 2 minutes.
6. Gybe and sail for 2 minutes.
7. Select the *[Finished]* button.

You can *[Pause]*/*[Resume]* the calibration using the relevant buttons.

You can cancel the calibration at anytime by selecting the *[Cancel]* button.

RSW series wind transducer configuration

The RSW series of wind transducers requires configuration to ensure accurate readings are presented.

It is recommended that wind transducers are installed facing directly forwards, in line with the mast centreline. If this is not possible then an angle of the offset from the mast centreline must be configured as follows:

- On a non-rotating mast where a heading sensor is present, the wind transducer will automatically compensate for any offset between installation angle and vessel centerline (heading).
- On a non-rotating mast where no heading sensor is present and the transducer has not been installed facing directly forwards, it is important that an offset is applied to account for the difference between the mast's centerline and the transducer's installation angle.
- On a non-rotating mast, if poor heading sensor readings are affecting wind readings, vessel heading can be ignored. However, an offset must be applied to account for the difference between the vessel's centerline and the transducer's installation angle.
- On a rotating mast a heading sensor is required so that wind readings compensate for mast angle. It is important that an offset is applied to account for the difference between the mast's centerline and the transducer's installation angle. The transducer will automatically compensate for the difference between heading and mast angle.

Non-rotating mast example

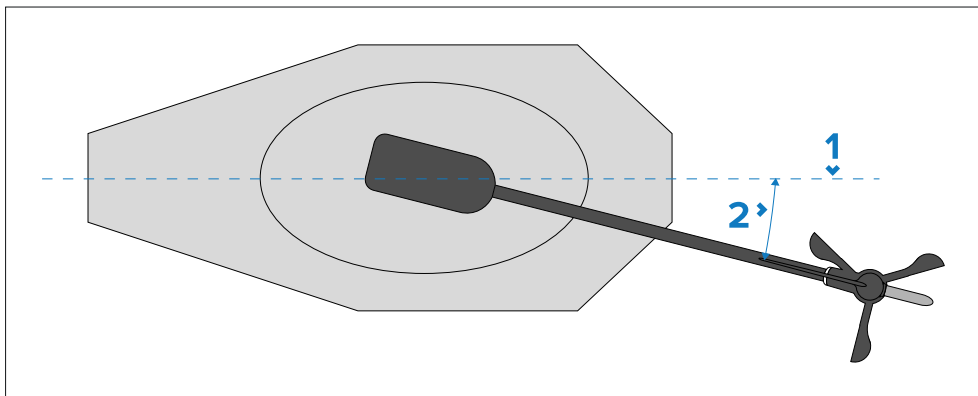

1. Vessel/mast centerline.
2. Offset angle.

Getting started

Note:

Offset only needs to be entered if there is no heading sensor.

Rotating mast example

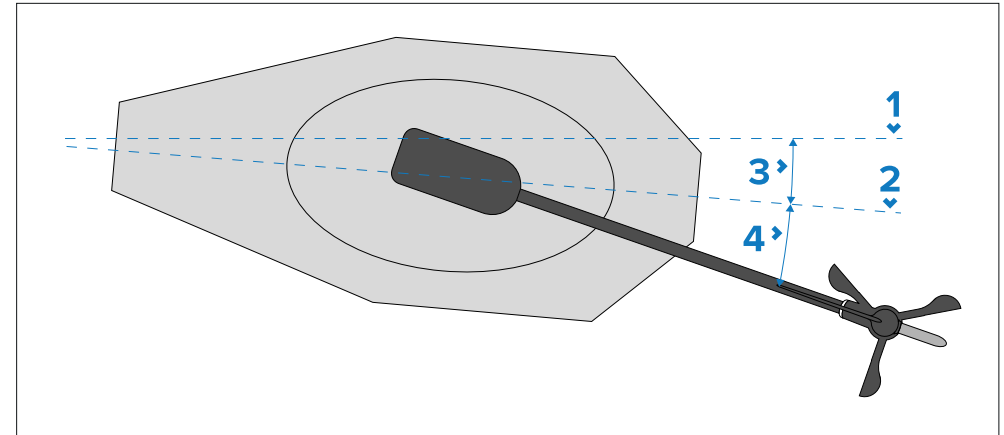

1. Vessel centerline.
2. Mast centerline.
3. Mast rotation.
4. Offset angle.

Note:

A heading sensor and, where applicable, offset angle is required.

Configuring RSW wind using LightHouse 4 display

The RSW wind transducer can be configured using an Axiom display, running LightHouse™ 4, version v4.6.74 or later.

The RSW wind transducer configuration is initiated from the *[Network]* settings menu: *[Homescreen > Settings > Network]*

1. Select the *RSW Wired Gateway* from the network list.
2. Select *[Configure settings]* from the Pop-over options.
3. If your vessel has a rotating mast:
 - i. Enable the *[Rotating mast]* toggle switch.

ii. If applicable, enter the offset value for your transducer.

- A vessel heading sensor is required for rotating masts.
- The offset should be measured from the mast's centerline to the transducer. This may be different from the vessel centerline.

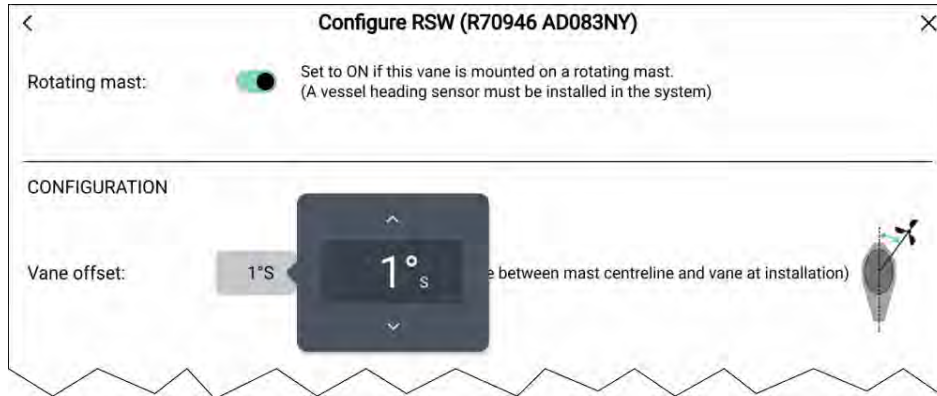

4. If your vessel does not have a rotating mast and does not have a heading sensor; if applicable, enter the offset value for your transducer.

- The offset should be measured from the vessel/mast's centerline to the transducer.

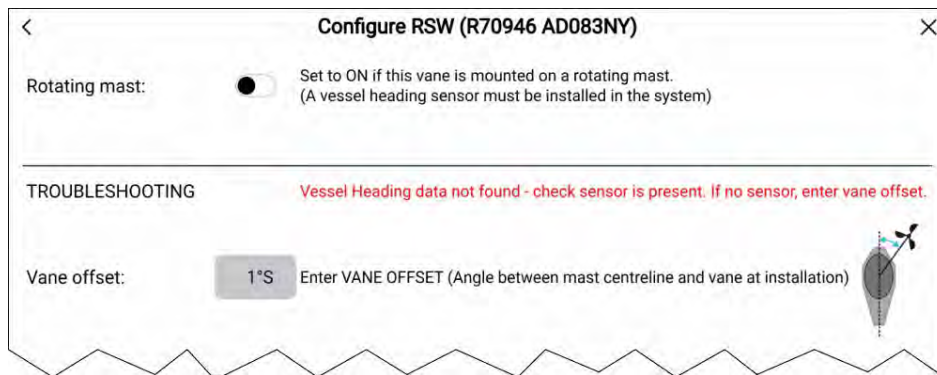

5. If your vessel does not have a rotating mast but does have a heading sensor, no offset value is required. However, if poor heading data is affecting wind data readings you can enable the *[Ignore sensor heading data]* toggle switch and if applicable, enter an offset value for your transducer.

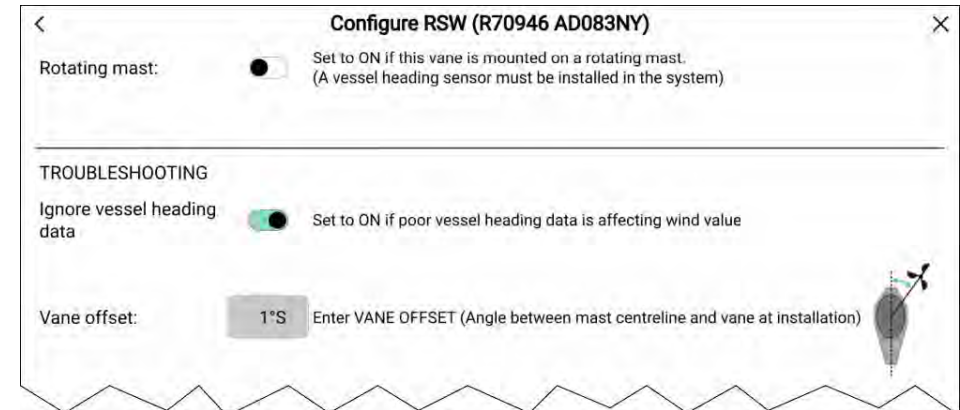

RSW Internal compass calibration

The RSW transducer's internal compass needs to compensate for local and the Earth's magnetic fields. This is achieved using an automatic process known as linearization.

Initial linearization

When the RSW transducer is first installed and powered-up (or after a factory reset or compass reset) the linearization process will start automatically.

Linearization requires no user input.

The time it takes to complete the linearization will vary according to the characteristics of the vessel, the installation environment and the levels of magnetic interference.

You can speed-up the linearization process by completing full 360° turns at a speed of between 3 and 15 knots.

After the initial linearization has completed the RSW transducer will continue to monitor and adapt its calibration to ensure optimum performance in current conditions.

Resetting compass calibration (LightHouse 4)

If significant reading anomalies are experienced the compass calibration process may need to be reset.

From the *[Network]* settings menu: *[Homescreen > Settings > Network]*

1. Select the RSW wind transducer from the list.

Ensure you select the wind transducer and not the RSW gateway.

2. Select *[Configuration settings]*.
3. Select the Compass calibration *[Reset]* button.
4. Select *[Yes]*.

The calibration is reset and will start again when the calibration conditions are met.

5.5 Shortcuts menu

The Shortcuts menu can be accessed by swiping left to right across the *[Power swipe]* area on touchscreen displays or by pressing the physical *[Power]* button.

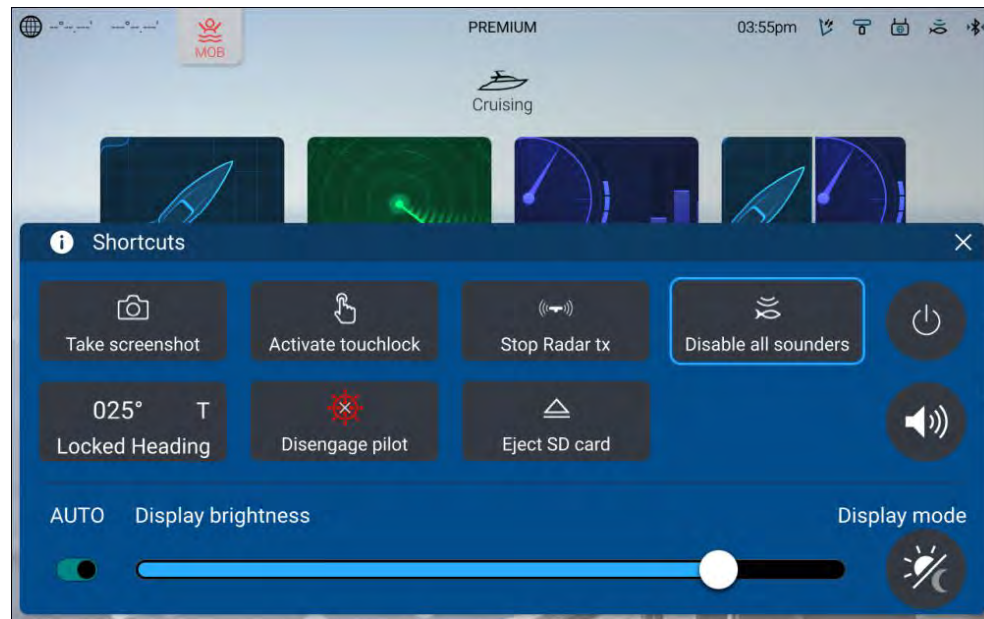

Note:

Some of the displayed options are dependent on connected hardware, e.g. the *[Engage pilot]*/*[Disengage pilot]* option is only available if you have a compatible autopilot system connected and integrated with your display.

The following shortcuts are available.

- Take Screenshot

[Getting started](#)

- Activate Touchlock
- Stop Radar transmitting
- Disable all Sounders
- Adjust Locked heading
- Engage / Disengage autopilot
- Eject SD card
- Power off
- Adjust audio speaker volume
- Adjust Brightness
- Toggle auto brightness on and off (Axiom® 2 displays only).
- Display mode

Taking a screenshot

You can take a screenshot and save an image of what is currently displayed on the screen to an external memory card.

The memory card that screenshots will be saved to can be selected from the *[This display]* settings menu: *[Homescreen > Settings > This display > Screenshot file:]*.

Screenshots are saved in .png format in the following location on your memory card '**\Raymarine\Image files**'.

1. Use the *[Power swipe]* or *[Power]* button to open the Shortcuts menu.
2. Select *[Take screenshot]*.
3. Select *[OK]* on the screenshot notification.

Displays that have physical buttons can also have a user-configurable key assigned as a *[Take screenshot]* button.

Note:

- Ensure that the memory card is ejected safely using the *[Eject SD card]* option from the Shortcuts menu.
- Due to protected content restrictions, you cannot take a screenshot of a feed that could contain copyrighted materials, such as the HDMI input.

Activating touchlock

In rough weather conditions precipitation may lead to erroneous touches being detected by the touchscreen. In these conditions you can use touchlock to prevent this.

1. Select *[Activate touchlock]* from the *[Shortcuts]* menu.

With touchlock activated the touchscreen will be disabled. To re-enable the touchscreen, swipe from left to right across the [Power swipe] area, or press the power button.

Radar standby

You can place a transmitting Radar in Standby from the Shortcuts menu.

1. Select *[Stop Radar tx]* from the *[Shortcuts]* menu.

You can start your radar transmitting again from the Radar app.

Eject SD card

Safely eject your SD card from your MFD.

Important:

Failure to eject cards safely may result in corrupted data or memory cards.

1. Select *[Eject SD card]* from the *[Shortcut]* menu.
2. Select the card reader slot you want to eject from the pop-over menu.
3. Physically eject the card from the reader.
4. Select *[I have removed SD cards]* to complete the process.

Enabling/Disabling sonar modules

Your sonar module can be enabled and disabled from the shortcuts menu. In systems with multiple sonar modules the control will enable and disable all connected sonar modules.

1. Select *[Enable all sounders]* or *[Disable all sounders]*.

Autopilot shortcuts

When Autopilot control is enabled, the shortcuts menu provides an autopilot icon which can be used to engage and disengage your autopilot

When the autopilot is engaged in locked heading mode you can also adjust the locked heading from the Shortcuts menu.

Audio volume control

When your display has audio speakers connected via Bluetooth, or via RCA connections on Axiom® 2 displays, volume controls will be available in the Homescreen status area. Additionally, on the Shortcuts menu, separate controls are available for the audio volume and alarms volume for Apps.

Homescreen status area

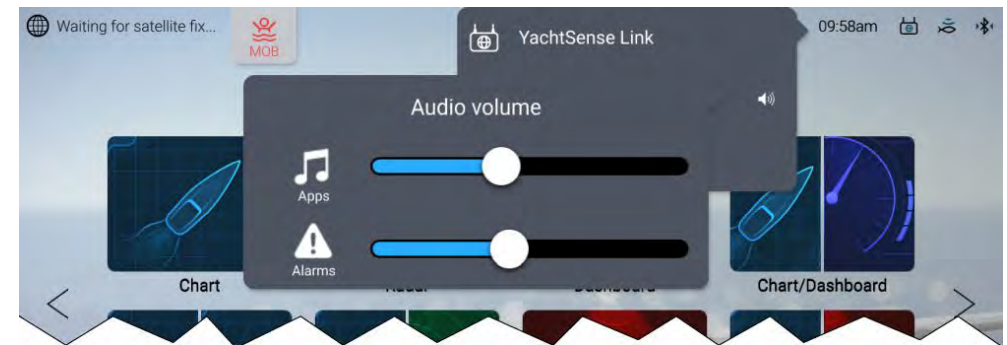

From the Homescreen, select the status area located on the top right of the screen, and then select the Speaker symbol to display the volume controls.

Shortcuts menu

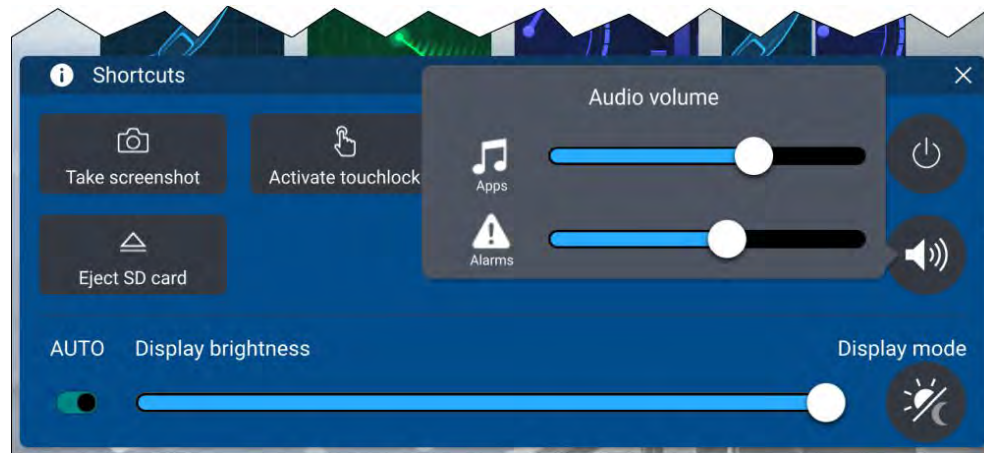

From the Shortcuts menu, select the speaker symbol to display the volume controls.

Use your finger to move the volume control along the relevant slider bar to adjust the volume.

Note:

A Bluetooth speaker will take priority over RCA audio and HDMI out (i.e.: if all are connected, audio will only be output from the Bluetooth speaker; if only RCA and HDMI out are connected, the audio will play from both. In this scenario, to output from RCA audio / HDMI out instead, switch the Bluetooth speaker off).

Adjusting brightness

Screen brightness can be adjusted from the Shortcuts menu.

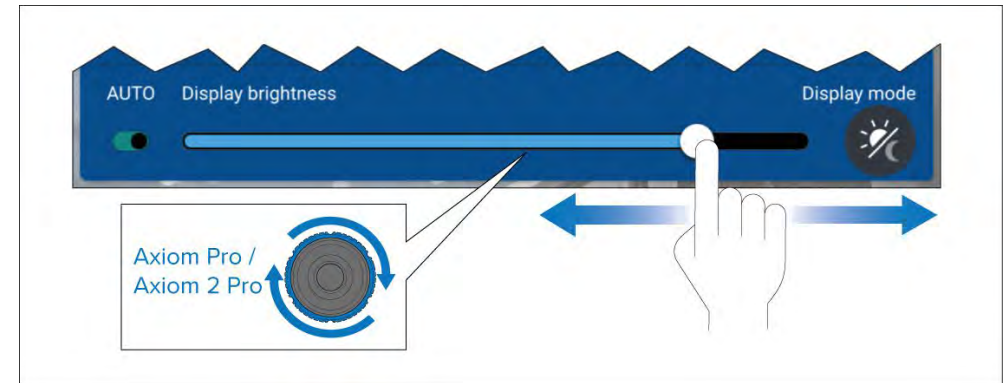

With the Shortcuts menu displayed:

1. Use your finger to move the *[Display brightness]* control along the slider bar to adjust the brightness level.

On Axiom® Pro and Axiom® 2 Pro displays you can twist the uni-controller to adjust the brightness level.

When the Shortcuts menu is displayed you can also use the *[Power]* button or the *[Power swipe]* area to increase the brightness level in increments.

Auto brightness

Axiom® 2 displays include an Ambient Light Sensor, which automatically adjusts the screen brightness to reflect the level of ambient lighting in the surrounding environment.

To allow the display to adjust brightness automatically, enable the *[AUTO]* toggle switch in the Shortcuts menu.

Note:

Auto brightness works in conjunction with the *Shared Brightness* feature, so that when an Axiom® 2 display's brightness automatically changes, compatible display products in the same *Shared Brightness* group will also be automatically adjusted to match the brightness level of the Axiom 2 Pro display.

Display mode

In addition to the default *[Day]* display mode the MFD can also be configured for night time use using the *[Night]* or *[Extra dark]* display modes.

The display mode can be changed by selecting the *[Display mode]* icon from the shortcuts menu.

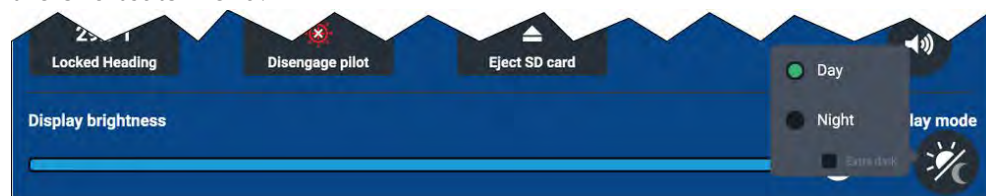

Press the *[Power]* button / swipe the *[Power swipe]* touch control to display the *[Shortcuts]* menu and then select the *[Display mode]* icon. You can then switch between *[Day]*, *[Night]*, and *[Extra dark]* display modes.

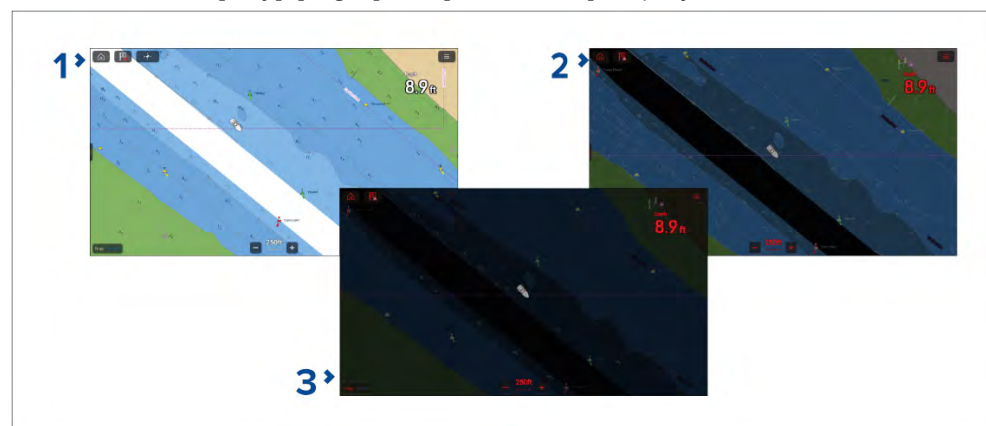

1. *[Day]*— This is the default mode and uses standard colors using either the *[Light]* or *[Dark]* color theme that is selected in the *[This display]* settings menu: *[Homescreen > Settings > This display]*.
2. *[Night]*— Uses red text and icons and dark background colors.
3. *[Extra dark]*— Uses red text and icons and very dark background colors. Extra dark mode is only available when dark mode is active.

Note:

When using the *[Night]* or *[Extra dark]* mode at night, be careful if changing back to *[Day]* mode or accessing an MFD screen that does not support the mode, as the higher display brightness may compromise your night vision.

5.6 Device pairing

Pairing a RMK remote keypad

You can control your MFD with an RMK keypad.

From the *[This display]* tab of the *[Settings]* menu: *[Homescreen > Settings > This display]*.

1. Select *[Pair keypad]*.
2. Follow the onscreen instructions to pair your keypad.

Ensure you select the correct orientation for the keypad during the pairing process.

3. Repeat steps 1 and 2 on each MFD you want to control from your keypad.

Note:

Please refer to the controls section of your keypad's documentation for details on controlling MFDs using a keypad.

Clear pairing (RMK)

1. Select *[Clear pairings]* to unpair ALL RMK keypads currently paired with the MFD.

Pairing with a Quantum Radar scanner

You can connect a Quantum Radar scanner to your MFD using Wi-Fi.

Pre-requisites:

- Ensure you have connected your Quantum Radar scanner in accordance with the instructions provided with the Radar scanner.
- Ensure you know your Radar scanner's SSID and passcode.

1. Select *[Pair with Quantum]* from the *[This display]* tab: *[Homescreen > Settings > This display > Pair with Quantum]*.
2. Follow the onscreen instructions to pair with your Quantum Radar.

The pairing process may take several minutes to complete.

For more information on the Quantum Radar pairing process (including troubleshooting information), refer to the Quantum Radar Installation instructions documents.

Pairing a Bluetooth speaker

Before attempting to pair with a Bluetooth speaker, ensure that the speaker is switched on and discoverable.

With your MFD's Bluetooth function enabled:

1. From the Bluetooth settings page, select the relevant device from the *[Available devices]* list.
2. If requested, confirm the Bluetooth pairing code.

If pairing is successful, the speaker will appear in the *[Paired devices]* list and display the *[Connected]* message.

5.7 Networking constraints

In systems that include more than one MFD/Chartplotter, the MFDs/Chartplotters must be networked together using an ethernet network. The ethernet network can be either a direct RayNet cable connection or connection via a network switch such as the RNS-5. The following constraints apply when networking MFDs/Chartplotters:

Ethernet networks

- Any network including more than one MFD/Chartplotter must have a designated **Datamaster**.
- The Datamaster MFD/Chartplotter is the primary display in the system and will receive data from NMEA 2000 / SeaTalk NG and, if applicable, NMEA 0183 devices. The data received by the Datamaster will be bridged over the ethernet network to other networked MFDs/Chartplotters.
- Up to 10 MFDs/Chartplotters can be connected to the same network. It is recommended that all networked MFDs/Chartplotters have the same software version.
- Other ethernet devices connected directly to an MFD/Chartplotter will be shared with networked MFDs/Chartplotters.
- Networked MFDs/Chartplotters will share the Datamaster's Homescreen. Changes made to the Homescreen on any MFD/Chartplotter will be reflected on all networked MFDs/Chartplotters.
- Electronic cartography stored on internal or external memory on any MFD/Chartplotter can be shared by all MFDs/Chartplotters on the same network.
- Up to 2 Radar scanners can be connected to the same network and used simultaneously.

- Multiple Sonar modules can be connected to the same network and used simultaneously.
- MFDs/Chartplotters with an internal sonar module can share sonar data with networked MFDs/Chartplotters.

For details regarding internet connections, refer to:

[p.84 – Internet connection](#)

For details regarding networking third-party ethernet products, refer to:

[p.550 – Ethernet \(IPv4\) networking of Raymarine devices with third-party products](#)

Wi-Fi networks

- MFD/Chartplotter Wi-Fi connection can be used to provide internet connection via an access point.
- MFDs/Chartplotters that have an internet connection using Wi-Fi will share the internet connection with ethernet networked MFDs/Chartplotters.
- An internet connection over ethernet will take precedence over an internet connection over Wi-Fi.
- Data from ethernet networked devices is not bridged over a Wi-Fi connection.
- Data from NMEA 2000 / SeaTalk NG devices is not bridged over a Wi-Fi connection.

NMEA 2000 / SeaTalk NG networks

- Only the Datamaster MFD/Chartplotter needs to be connected to the NMEA 2000 / SeaTalk NG backbone.
- If more than one MFD/Chartplotter is connected to the backbone, only the Datamaster MFD/Chartplotter will receive data from other devices on the backbone.
- The Datamaster MFD/Chartplotter will bridge NMEA 2000 / SeaTalk NG data over the ethernet network to other MFDs/Chartplotters.
- More than one MFD/Chartplotter can be connected to the same backbone for data redundancy purposes. If the **Datamaster** MFD/Chartplotter fails, another networked MFD/Chartplotter can take its place as the Datamaster.

Networking with legacy MFDs/Chartplotters

- Axiom 2 Pro MFDs/Chartplotters cannot be networked to legacy MFDs/Chartplotters running LightHouse 2.
- Axiom MFDs/Chartplotters running earlier versions of LightHouse 3 can be networked to legacy MFDs/Chartplotters. For further

details on networking legacy MFDs/Chartplotters, refer to:
[p.34 – Legacy eS and gS Series compatibility with Axiom displays](#)

- Alpha Performance displays cannot be networked to legacy displays running LightHouse 2.

5.8 Internet connection

Some features require the display to have a connection to the internet.

Note:

In versions of the YachtSense™ Link router software *later than v4.20*, the display cannot connect to the router's Wi-Fi access point.

The display can be connected to the internet using the following methods:

- Connecting the display's Wi-Fi connection to a Wi-Fi access point which has an internet connection, such as marina Wi-Fi or mobile device. For connection details, refer to: [p.84 – Connecting to the internet using Wi-Fi](#)
- Connecting the display's RayNet Ethernet connection to a YachtSense™ Link router which has internet access. Requires YachtSense™ Link router software **v4.20** or above
- Connecting the display's Wi-Fi connection to a YachtSense™ Link router which has internet access. Requires YachtSense™ Link router software **v4.17** or earlier.
- Connecting the display's Wi-Fi or RayNet Ethernet connection to a third-party router which has internet access

Note:

- When connecting to a YachtSense™ Link router, follow the instructions provided with the router to set up an internet connection.
- When using a third-party router, follow the instructions provided with it to set up an internet connection and then follow the guidance in the appendix of this document to help you configure internet access:
[p.550 – IP Networking of Raymarine devices with Third-party products](#)

YachtSense Link network connection

For optimum internet performance, Raymarine displays should be connected to the router via a wired RayNet Ethernet connection.

For YachtSense™ Link router software versions from **v4.20** onwards, it is no longer possible for a display to connect to the router's Wi-Fi Access Point.

Software version	Description
<i>Earlier than v4.20</i>	Display may be connected to the YachtSense™ Link router's Wi-Fi Access Point. However, functionality will be limited to providing an internet connection for third-party apps which require internet access, such as <i>Netflix</i> .
v4.20 or later	Display cannot connect to the YachtSense™ Link router's Wi-Fi Access Point. <div data-bbox="1406 691 2065 983" style="border: 1px solid black; padding: 5px;"><p>Note: For YachtSense™ Link routers which previously had a Wi-Fi connection to a display and have since been upgraded to v4.20 from an earlier software version, the display will receive an IP address conflict notification. To correct the conflict, select <i>[Forget network]</i> in the displayed notification popup.</p></div>

Connecting to the internet using Wi-Fi

The display can be connected directly to an access point that has an internet connection.

From the Homescreen:

1. Select the *[Apps]* icon from the Homescreen.
The app launcher is displayed.
2. Select the connection status button, located on the top right of the app launcher page.
The Wi-Fi settings page is displayed and will scan for available networks.

Note:

If there is a YachtSense™ Link router connected to your system selecting this button will display the router's web interface.

3. Select the relevant Wi-Fi access point.
4. Enter the password for the network and select *[Connect]*.
Your display will now connect to the access point.
5. Select the *[Back]* triangle symbol or the *[Home]* circle symbol at the bottom of the screen.

Your display should now have an internet connection.

Wi-Fi settings — Axiom displays

The Wi-Fi settings menu provides settings to connect the display to a Wi-Fi access point or hotspot.

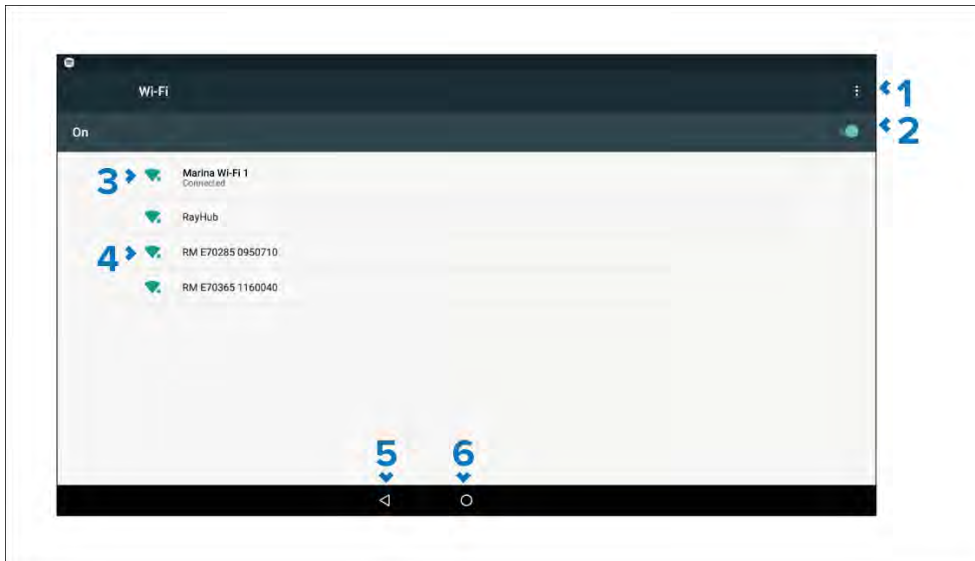

1. Wi-Fi options — Provides the following options:
 - Add network — Manually add a network.
 - Saved networks — View a list of all saved networks.
 - Refresh — Rescan available networks.
 - Advanced — View advanced network settings.

2. Enable/Disable Wi-Fi.
3. Connected access point.
4. Available access points.
5. Back button — Go back to the previous menu.
6. Home button — Go back to the previous menu.

Wi-Fi settings — Axiom 2 displays

The Wi-Fi settings menu provides settings to connect the display to a Wi-Fi access point or hotspot.

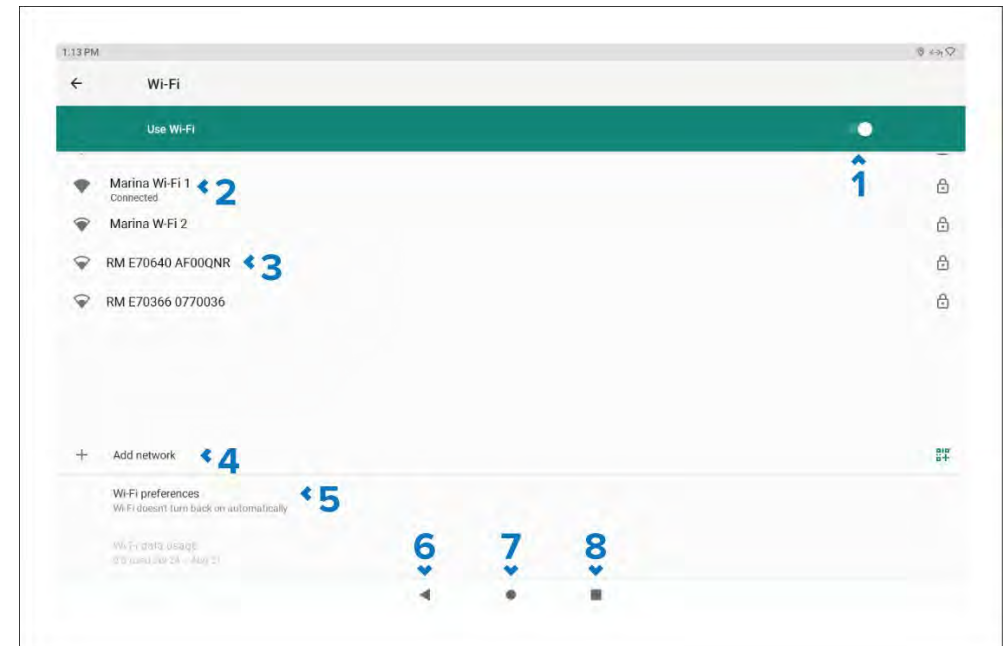

1. **Enable/Disable Wi-Fi.**
2. **Connected Access Point (AP).**
3. **Available Access Points (AP).**
4. **Add network** — Manually add a network.
5. **Wi-Fi preferences** — Provides Wi-Fi connection options.
6. **Back button** — Go back to the previous menu.
7. **Home button** — Go back to the previous menu.

8. **View open apps** — Go back to an open LightHouse apk app.

CHAPTER 6: HOMESCREEN

CHAPTER CONTENTS

- 6.1 Accepting the Limitations on Use — page 88
- 6.2 Homescreen overview — page 88
- 6.3 Homescreen app page icons — page 89
- 6.4 MFD Apps — page 89
- 6.5 Creating an app page — page 95
- 6.6 Homescreen Dynamic tile — page 96
- 6.7 Global positioning — page 97
- 6.8 Status area — page 102
- 6.9 My data — page 104
- 6.10 My profiles — page 108

6.1 Accepting the Limitations on Use

After your MFD has powered up the Homescreen is displayed with the limitations on use disclaimer.

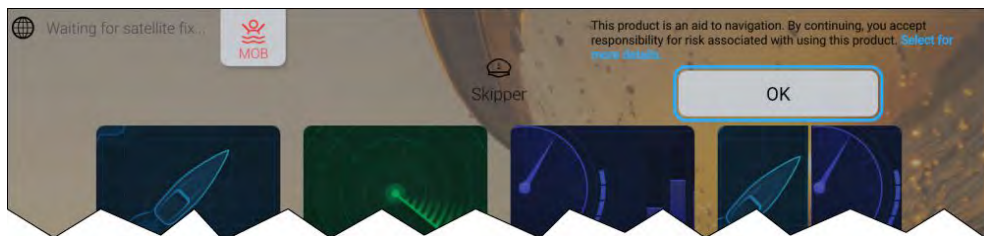

1. Before using the MFD you must accept the Limitations on Use (LoU) disclaimer. To view the full LoU Disclaimer, select the *[Select for more details]* link.

The LoU acknowledgment is displayed each time the display is powered on and for each new user profile. The full LoU text can be accessed at any time from the [Getting started] settings menu: [Homescreen > Settings > Getting started > View terms of use].

Note:

By selecting the OK button you are agreeing to the full terms of use.

6.2 Homescreen overview

All settings and apps are accessed from the Homescreen. The homescreen is split into 3 pages. The center page is shown by default.

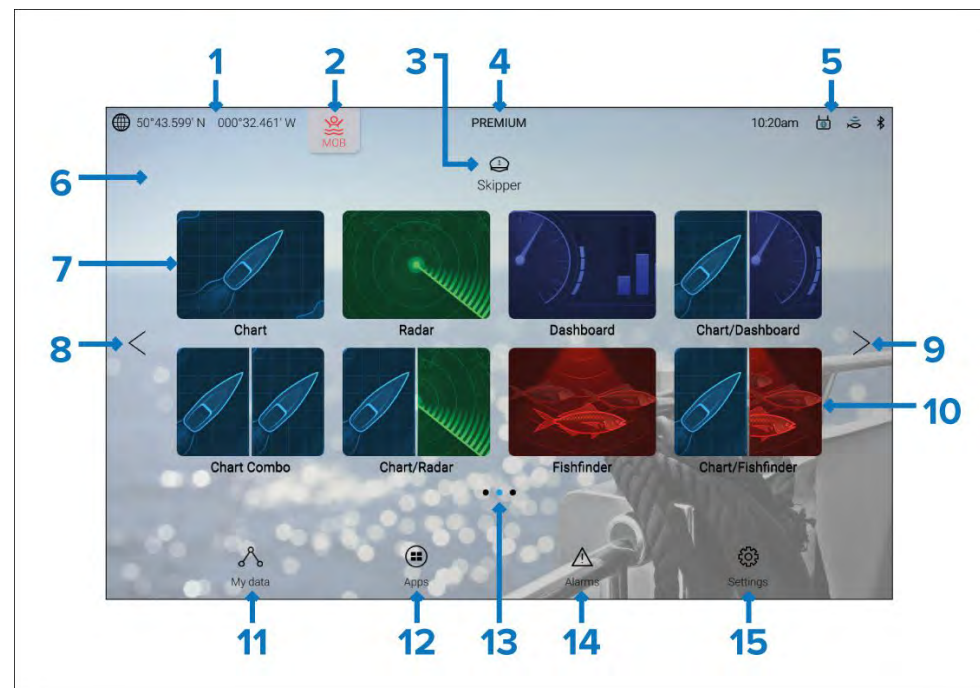

1. **GNSS position/fix details** — Select the text or icon to view GNSS settings and fix accuracy details. For details refer to: [p.99 — GNSS \(GPS\) Status](#)
2. **MOB (Man Over Board)** — Select and hold to activate the MOB alarm. For details refer to: [p.131 — Man Overboard \(MOB\)](#)
3. **Profiles** — Select the text or icon to access user and demo profiles. For details refer to: [p.108 — My profiles](#)
4. **Premium logo** — The premium logo identifies that you have a LightHouse™ chart card inserted that has a valid premium subscription. The logo is not displayed if your subscription has expired. For details refer to: [p.203 — LightHouse charts](#)
5. **External device connections and system time** — Icons are displayed to signify external device connections. Select this area to access Bluetooth and YachtSense™ Link settings, disengage your autopilot or to adjust the UTC time offset. For details refer to: [p.102 — Status area](#)

6. **Homescreen background image** — The default image is determined by the boating activity selected during the start up wizard. The background image can be customized from the *[This display]* settings menu: *[Homescreen > Settings > This display]*. For details refer to: [p.119 — Splashscreen and background images](#)
7. **Fullscreen app page icon** — Select an icon to open the relevant MFD app page. For available MFD apps refer to: [p.89 — MFD Apps](#)
8. **Homescreen page navigation** — Select the *[<]* (left) arrow, or swipe your finger from left to right across the homescreen to cycle through homescreen pages on the left.
9. **Homescreen page navigation** — Select the *[>]* (right) arrow, or swipe your finger from right to left across the homescreen to cycle through homescreen pages on the right.
10. **Splitscreen app page icon** — Select an icon to open the relevant MFD app page. App pages can contain more than 1 MFD app. For details on creating new homescreen app pages refer to: [p.95 — Creating an app page](#)
11. **My data** — Select to access my data (Waypoints, Routes and Tracks), the fuel manager and to view files on external storage. For details refer to: [p.104 — My data](#)
12. **App launcher** — Select to access installed Android apk apps and shortcuts to user interfaces for integrated partner hardware. For details refer to: [p.499 — App launcher](#)
13. **Homescreen page navigation** — Identifies the current homescreen page.
14. **Alarm manager** — Select to access the alarm manager and view alarm history. For details refer to: [p.126 — Alarms manager](#)
15. **Settings menus** — Select to access the MFD's settings menu. For details refer to: [p.110 — Settings](#)

Note:

When more than one display is connected to the same network, the Homescreen of the MFD designated as datamaster will be mirrored on all MFDs.

6.3 Homescreen app page icons

Two sets of Homescreen app page icons are available *[Classic icons]* and *[Mode icons]*. By default the *[Classic icons]* are used.

Example Homescreen using Mode icons

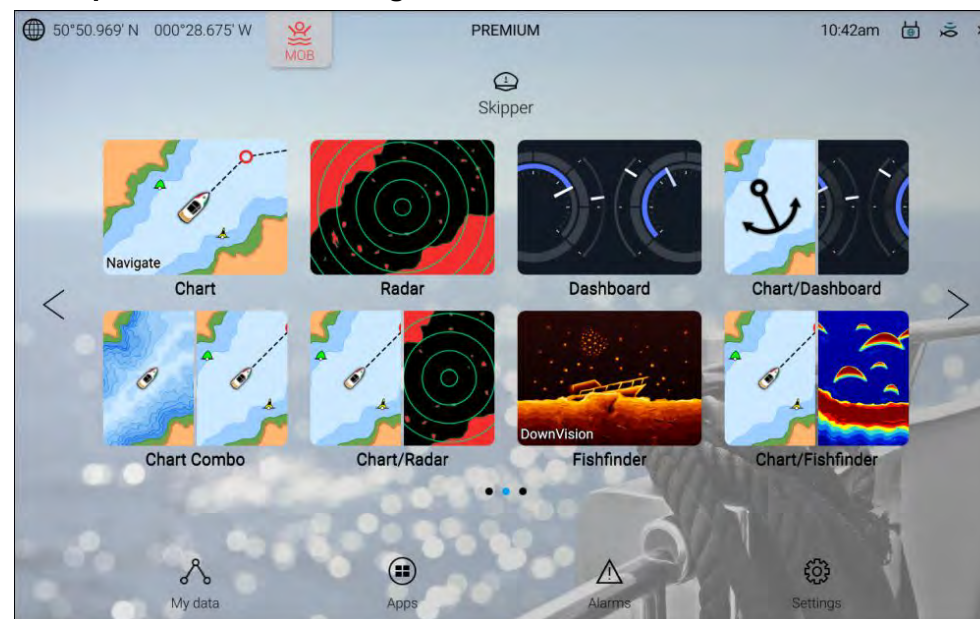

The mode icon style provide a clearer indication of the appearance of the app when in use.

Chart app and Fishfinder app icons will change dynamically to indicate which Chart mode or Fishfinder channel is in use.

The style of Homescreen icons can be selected from the *[Getting started]* menu: *[Homescreen > Settings > Homescreen]*

6.4 MFD Apps

MFD apps are displayed in app pages. App pages are accessed from the Homescreen. App pages can be fullscreen, containing only one app, or they can be splitscreen, containing up to 4 apps.

The apps that appear on the Homescreen by default are determined by the boating activity chosen during the initial start up wizard.

Some apps are only available with specific MFD configurations, or when required hardware is connected.

Not all apps appear on the Homescreen by default. If an app is not present on the Homescreen, you can create a new app page that includes the app.

Chart app

The Chart app displays electronic cartographic information from your Chart cards and when used in conjunction with a GNSS receiver, plots your vessel's position. The Chart app can be used to mark specific locations using Waypoints, build and navigate Routes, or keep a record of where you have been by recording a Track.

To use the chart app for navigation, as a minimum navigational electronic charts and a GNSS receiver are required.

For more information refer to [p.190 — Chart app - General](#)

Chart app icons

The following icons can be used on the Homescreen for Chart app pages:

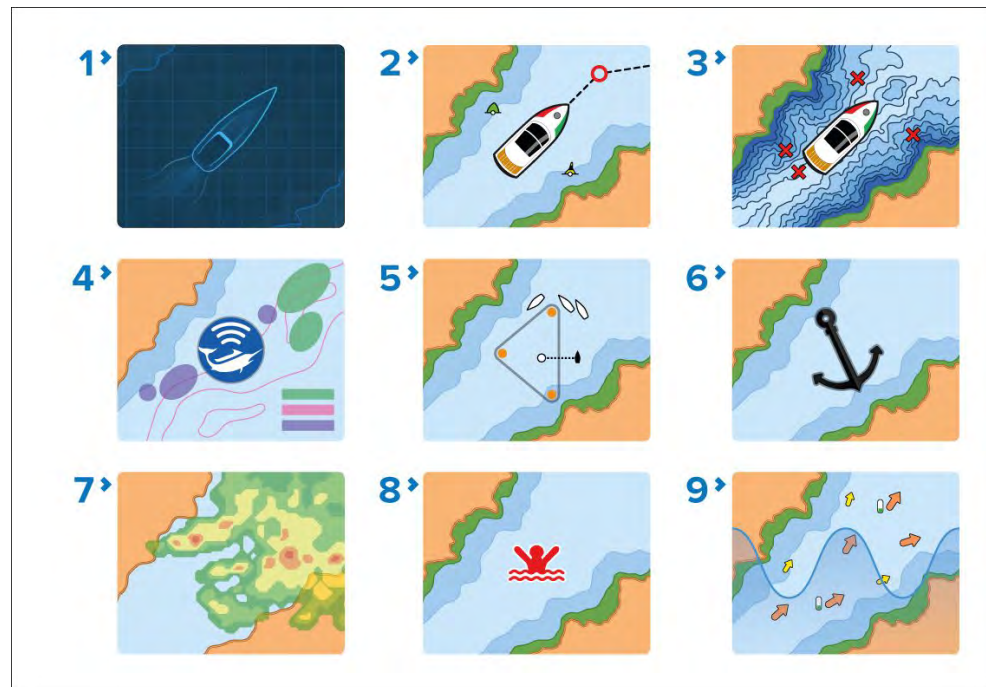

1. **Classic chart icon** — This is the icon used for all chart app pages when the Homescreen icons are set to the default *Classic icons*.

2. **Navigate mode icon** — When the Homescreen icons are set to *Mode icons*, this icon is used for charts app pages where the chart app is set to *[Navigate]* mode. The vessel icon will be updated dynamically to show your chosen vessel type.
3. **Fishing mode icon** — When the Homescreen icons are set to *Mode icons*, this icon is used for charts app pages where the chart app is set to *[Fishing]* mode. The vessel icon will be updated dynamically to show your chosen vessel type.
4. **Fish mapping mode icon** — When the Homescreen icons are set to *Mode icons*, this icon is used for charts app pages where the chart app is set to *[Fish mapping]* mode. When compatible hardware (e.g.: SR200) is detected, fish mapping mode will be available. Fish mapping mode also requires a valid SiriusXM subscription.
5. **Racing mode icon** — When the Homescreen icons are set to *Mode icons*, this icon is used for charts app pages where the chart app is set to *[Racing]* mode. Racing mode is available when the boating activity selected during the initial start up wizard was set to *Sailing*.
6. **Anchor mode icon** — When the Homescreen icons are set to *Mode icons*, this icon is used for charts app pages where the chart app is set to *[Anchor]* mode.
7. **Weather mode icon** — When the Homescreen icons are set to *Mode icons*, this icon is used for charts app pages where the chart app is set to *[Weather]* mode. When compatible hardware (e.g.: SR200) is detected, Weather mode will be available. Weather mode also requires a valid SiriusXM subscription.
8. **MOB mode icon** — When the Homescreen icons are set to *Mode icons*, this icon is used for charts app pages where the MOB alarm is currently active.
9. **Tides mode icon** — When the Homescreen icons are set to *Mode icons*, this icon is used for charts app pages where the chart app is set to *[Tides]* mode.

Radar app

The Radar app is a situational awareness aid that displays a graphical representation of your surroundings in relation to your vessel, using the echo/target returns from a connected Radar scanner. The Radar app allows you to track targets and measure distances and bearings.

To use the Radar app, a compatible radar scanner is required.

For more information, refer to: [p.327 — Radar app](#)

Radar app icons

The following icons can be used on the Homescreen for Radar app pages:

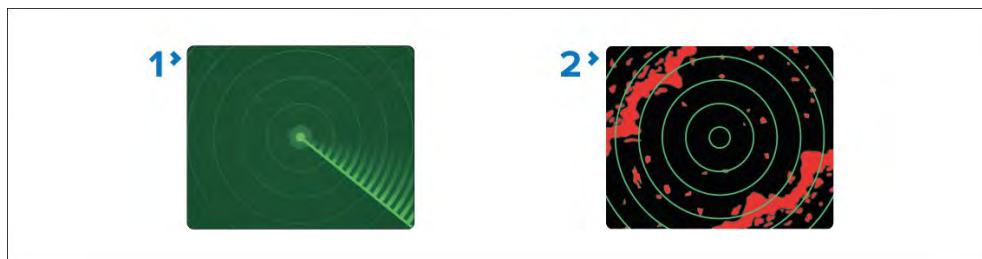

1. **Classic radar icon** — This is the icon used for all radar app pages when the Homescreen icons are set to the default *Classic icons*.
2. **Radar mode icon** — This is the icon used for all radar app pages when the Homescreen icons are set to *Mode icons*.

Fishfinder app

The Fishfinder app uses a connected sonar module and transducer to help you to find fish by building up an underwater view of bottom structure and targets in the water column covered by your transducer.

To use the Fishfinder app, a compatible sonar module and transducer is required.

For more information, refer to: [p.304 — Fishfinder app](#)

Fishfinder app icons

The following icons can be used on the Homescreen for Fishfinder app pages:

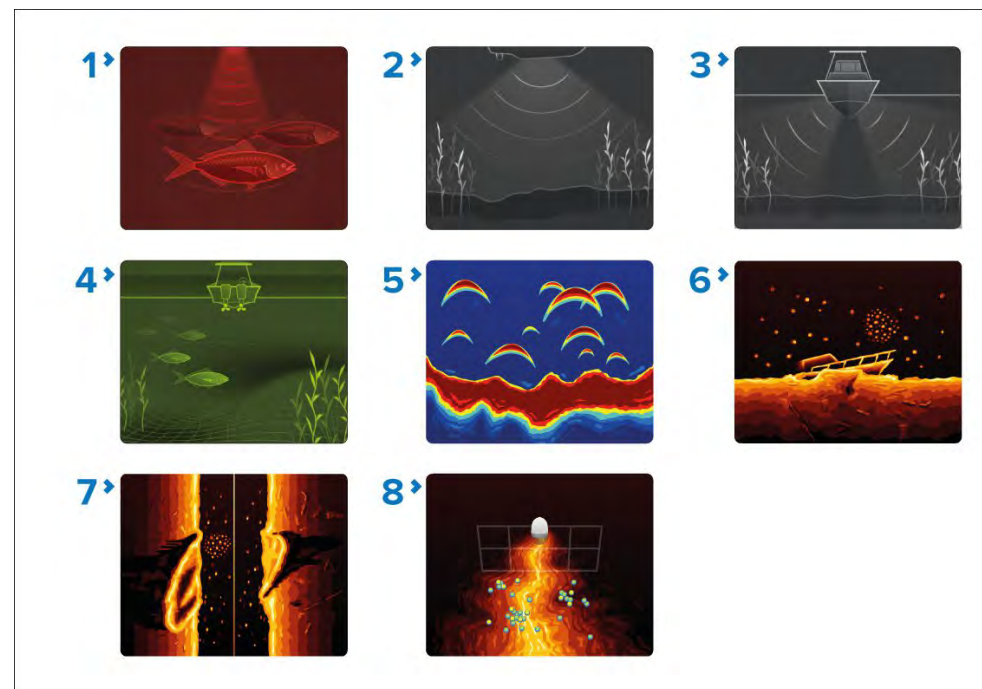

1. **Conical channel classic icon** — This is the icon used for fishfinder app pages when the Homescreen icons are set to the default *Classic icons* and the selected fishfinder channel has been set to a conical beam traditional or CHIRP sonar channel. The icon will look slightly differently depending on the chosen channel frequency. The icon will also change if *[Zoom]* mode is enabled.
2. **DownVision channel classic icon** — This is the icon used for fishfinder app pages when the Homescreen icons are set to the default *Classic icons* and the selected fishfinder channel has been set to DownVision. The icon will also change if *[Zoom]* mode is enabled.
3. **SideVision channel classic icon** — This is the icon used for fishfinder app pages when the Homescreen icons are set to the default *Classic icons* and the selected fishfinder channel has been set to SideVision.
4. **3D Vision channel classic icon** — This is the icon used for fishfinder app pages when the Homescreen icons are set to the default *Classic icons* and the selected fishfinder channel has been set to 3D Vision.
5. **Conical channel mode icon** — This is the icon used for fishfinder app pages when the Homescreen icons are set to the default *Mode icons*

and the selected fishfinder channel has been set to a conical beam traditional or CHIRP sonar channel. The icon will look slightly differently depending on the chosen channel frequency. The icon will also change if *[Zoom]* mode is enabled.

6. **DownVision channel mode icon** — This is the icon used for fishfinder app pages when the Homescreen icons are set to the default *Mode icons* and the selected fishfinder channel has been set to DownVision. The icon will also change if *[Zoom]* mode is enabled.
7. **SideVision mode icon** — This is the icon used for fishfinder app pages when the Homescreen icons are set to the default *Mode icons* and the selected fishfinder channel has been set to SideVision.
8. **3D Vision channel mode icon** — This is the icon used for fishfinder app pages when the Homescreen icons are set to the default *Mode icons* and the selected fishfinder channel has been set to 3D Vision.

Dashboard and Engine apps

The Dashboard app and Engine apps enable you to view data transmitted by compatible sensors and engines or engine gateways.

The Dashboard app is always available and can be used to view data transmitted by compatible sensors and engines or engine gateways. The Dashboard app is also used for controlling, configured, compatible, third-party Digital Switching hardware. For more information about the Dashboard app, refer to: [p.389 — Dashboard app](#)

The following engine-specific apps are available:

- Mercury app. For more information about the Mercury app, refer to: [p.413 — Mercury app](#)
- Yamaha app. For more information about the Yamaha app, refer to: [p.429 — Yamaha app](#)
- Yamaha HDMI app. For more information about the Yamaha HDMI app, refer to: [p.429 — Yamaha app](#)

Dashboard app page icons

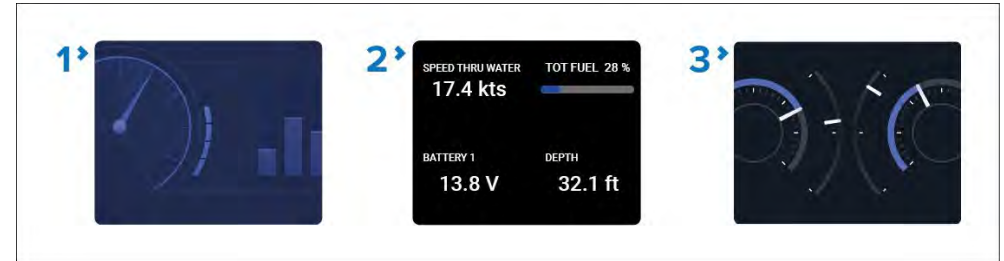

1. **Classic Dashboard icon** — This is the icon used for all Dashboard app pages when the Homescreen icons are set to the default *Classic icons*.
2. **Dynamic tile** — The Dynamic tile is available in both Homescreen icon modes and shows live data directly on the Homescreen. For more information about Dynamic tile, refer to: [p.96 — Dynamic tile](#).
3. **Dashboard mode icon** — This is the icon used for all Dashboard app pages when the Homescreen icons are set to *Mode icons*.

Engine app page icons



1. **Mercury app icon** — This icon is used in both *classic* icon and *mode* icon Homescreen modes. The Mercury app is only available when *Mercury* has been selected as the engine manufacturer from the *[Boat details]* settings menu. The app requires a compatible Mercury SmartCraft system.

2. **Classic Yamaha app icon** — This is the icon used for all Yamaha app pages when the Homescreen icons are set to the default *Classic icons*. The Yamaha app is only available when *Yamaha* has been selected as the engine manufacturer from the *[Boat details]* settings menu. The app requires a compatible Yamaha gateway.
3. **Classic Yamaha HDMI** — This is the icon used for all Yamaha HDMI app pages when the Homescreen icons are set to the default *Classic icons*. The Yamaha HDMI app is only available when *Yamaha HDMI* has been selected as the engine manufacturer from the *[Boat details]* settings menu. The app requires a compatible Yamaha HDMI interface.
4. **Yamaha mode icon** — This is the icon used for both the Yamaha or Yamaha HDMI app pages when the Homescreen icons are set to the *Mode icons*. The app is only available when *Yamaha* or *Yamaha HDMI* has been selected as the engine manufacturer from the *[Boat details]* settings menu. The app requires a compatible Yamaha gateway or Yamaha HDMI interface.

Entertainment apps

Entertainment apps are apps that can be used to view or listen to audio and visual sources on the display screen.

The following entertainment apps are available:

- **Audio app** — The Audio app allows you to control audio from a connected compatible entertainment system. For more information, refer to: [p.474 — Audio app](#)
- **Video app** — The Video app allows you to view and record feeds from connected compatible video equipment, such as an IP camera or Thermal camera. For more information, refer to: [p.440 — Video app](#)
- **PDF viewer** — The PDF Viewer app allows you to open PDF files located on external storage devices. For more information, refer to: [p.486 — PDF Viewer app](#)
- **YouTube TV** — The YouTube TV app allows you to watch live sports, shows and news directly on your MFD. For more information refer to: [p.471 — YouTube & YouTube TV](#)
- **YouTube** — The YouTube app allows you to watch YouTube content directly on your MFD. For more information refer to: [p.471 — YouTube & YouTube TV](#)

Entertainment app page icons

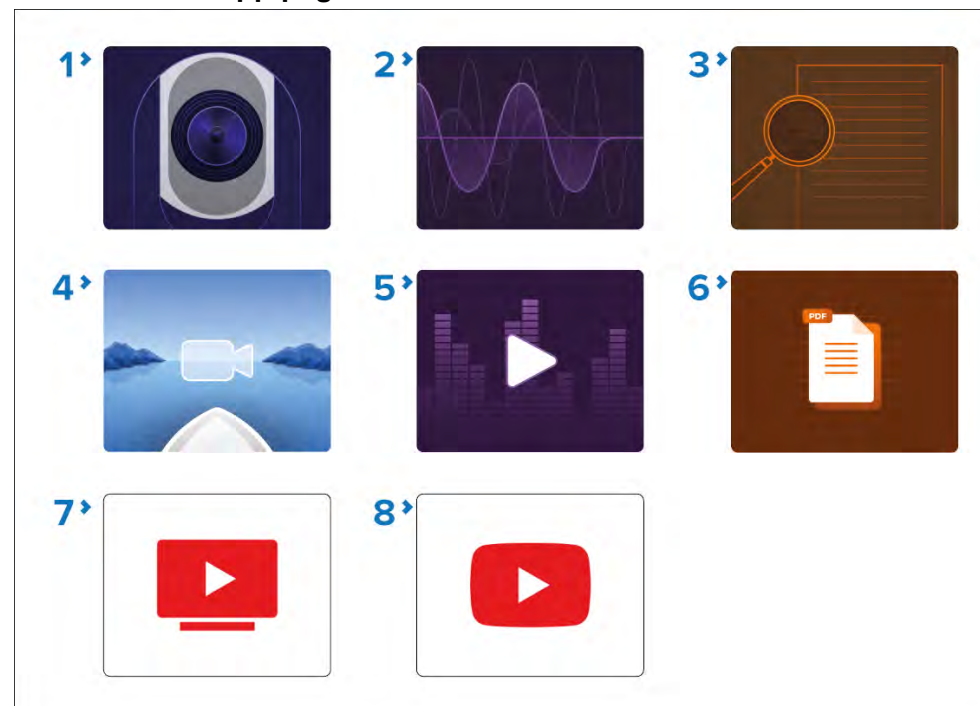

1. **Classic Video icon** — This is the icon used for all Video app pages when the Homescreen icons are set to the default *Classic icons*.
2. **Classic Audio icon** — This is the icon used for all Audio app pages when the Homescreen icons are set to the default *Classic icons*.
3. **Classic PDF viewer icon** — This is the icon used for all PDF viewer app pages when the Homescreen icons are set to the default *Classic icons*.
4. **Video mode icon** — This is the icon used for all Video app pages when the Homescreen icons are set to the default *Mode icons*.
5. **Audio mode icon** — This is the icon used for all Audio app pages when the Homescreen icons are set to the default *Mode icons*.
6. **PDF viewer mode icon** — This is the icon used for all PDF viewer app pages when the Homescreen icons are set to the default *Mode icons*.
7. **YouTube TV** — This icon is used for all YouTube TV app pages regardless of Homescreen icon setting.
8. **YouTube** — This icon is used for all YouTube app pages regardless of Homescreen icon setting.

YachtSense and DockSense apps

The YachtSense app is used for monitor and control of Raymarine's YachtSense™ Digital Control Systems. The DockSense™ app is used to control Raymarine's DockSense™ Alert or DockSense™ Control systems.

DockSense app

Requires a fully-commissioned DockSense system.

- For DockSense™ Alert, refer to separate operation instructions — document number 81393.
- For DockSense™ Control, refer to separate operation instructions — document number: 81398.

YachtSense app

Requires a fully-commissioned YachtSense Digital Control System.

The YachtSense app will be bespoke for each installation.

DockSense and YachtSense app page icons



1. **Classic YachtSense app icon** — This is the icon used for all YachtSense app pages when the Homescreen icons are set to the default *Classic icons*.
2. **Classic DockSense app icon** — This is the icon used for all DockSense app pages when the Homescreen icons are set to the default *Classic icons*.
3. **YachtSense mode icon** — This is the icon used for all YachtSense app pages when the Homescreen icons are set to the default *Mode icons*.

4. **DockSense mode icon** — This is the icon used for all DockSense app pages when the Homescreen icons are set to the default *Mode icons*.

Other apps

- **Messages app** — The First responder boating activity profile includes a Messages app. For details, refer to: [p.384 — Messaging app](#) The Messages app also requires STEDS-compatible AIS hardware.
- **NeuBoat Dock app** — The NeuBoat dock app requires a fully commissioned Avikus NeuBoat system. The *[NeuBoat Dock app]* combines a top down, bow up surround view around your vessel with up to 6 additional splitscreen camera views to provide assistance when performing docking maneuvers. For NeuBoat Dock operation, refer to separate operation instructions — document number 81418.

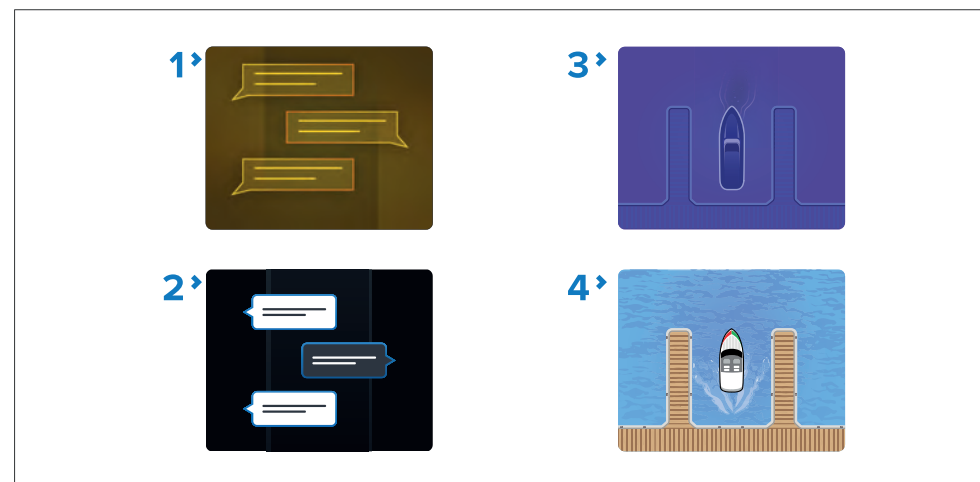

1. **Classic Messages icon** — This is the icon used for all Messages app pages when the Homescreen icons are set to the default *Classic icons*.
2. **Messages mode icon** — This is the icon used for all Messages app pages when the Homescreen icons are set to the default *Mode icons*.
3. **Classic NeuBoat Dock icon** — This is the icon used for all NeuBoat Dock app pages when the Homescreen icons are set to the default *Classic icons*.
4. **NeuBoat Dock mode icon** — This is the icon used for all NeuBoat Dock app pages when the Homescreen icons are set to the default *Mode icons*.

6.5 Creating an app page

New app pages can be created in the empty slots available on the homescreen.

App pages can include MFD apps (e.g.: Chart app, Radar app etc.) and also shortcuts to the user interface of 3rd party integration partner's hardware, if connected.

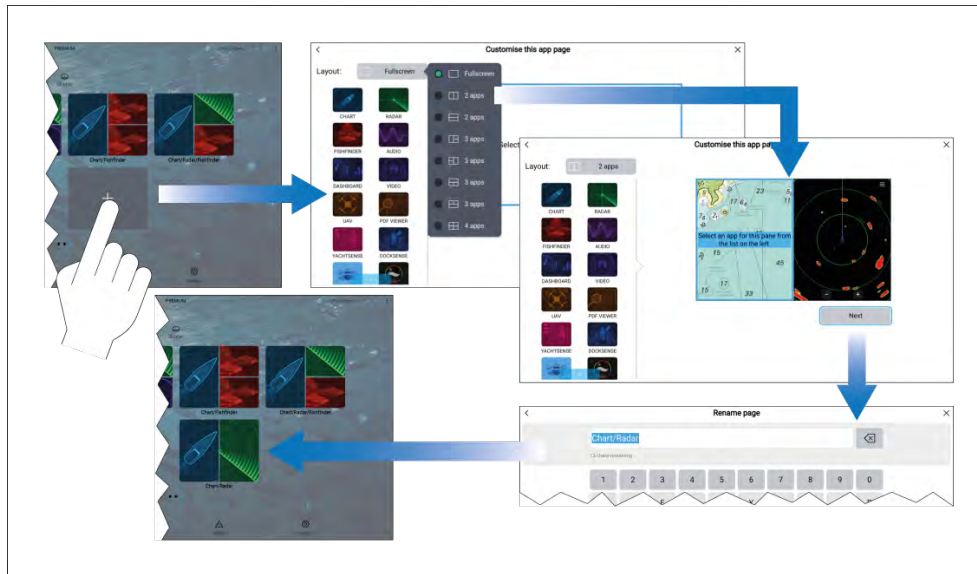

1. Press and hold on an empty slot on the homescreen.
2. Select the *[Layout:]* option and choose the desired page layout.
Some apps are restricted to certain layouts.
3. Select the icons for the Apps that you want to be displayed on the page.
4. Select *[Next]*.
5. Enter a name for your new app page.

A default name will be suggested.

6. Select *[Save]*.

The app page is saved and the new app page icon will be shown on the homescreen.

Additional mode icon steps

When the Homescreen is set to use Mode icons there are additional steps required when creating an app page which includes the Chart app or Fishfinder app.

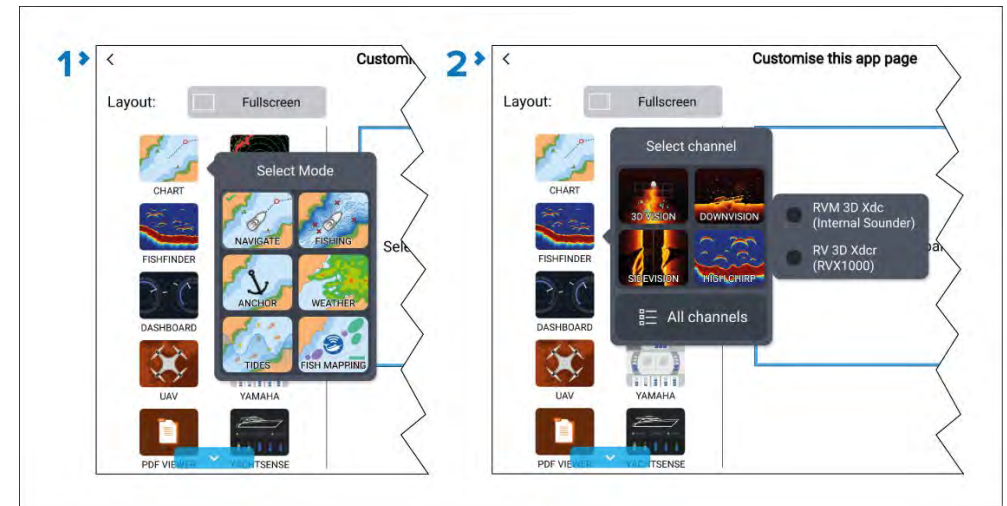

1. When creating a Chart app page you will need to also select the chart app mode that you want to use.
2. When creating a Fishfinder app page you will need to also select the channel and if applicable the transducer that you want to use.

Customizing an existing app page

You can rename, change the apps or delete existing app pages.

1. Select and hold on an existing app page icon on the homescreen.
2. Select from the following options:
 - *[Customize]*— Selecting Customize will open the page creation page where you can select the layout and which apps you want on the app page.
 - *[Delete]*— Selecting delete will delete the page from the homescreen. The delete action cannot be undone.
 - *[Rename]*— Selecting Rename will open the onscreen keyboard so that you can change the name of the app page.

Editing the splitscreen ratio

The size of the apps in a splitscreen app page can be changed.

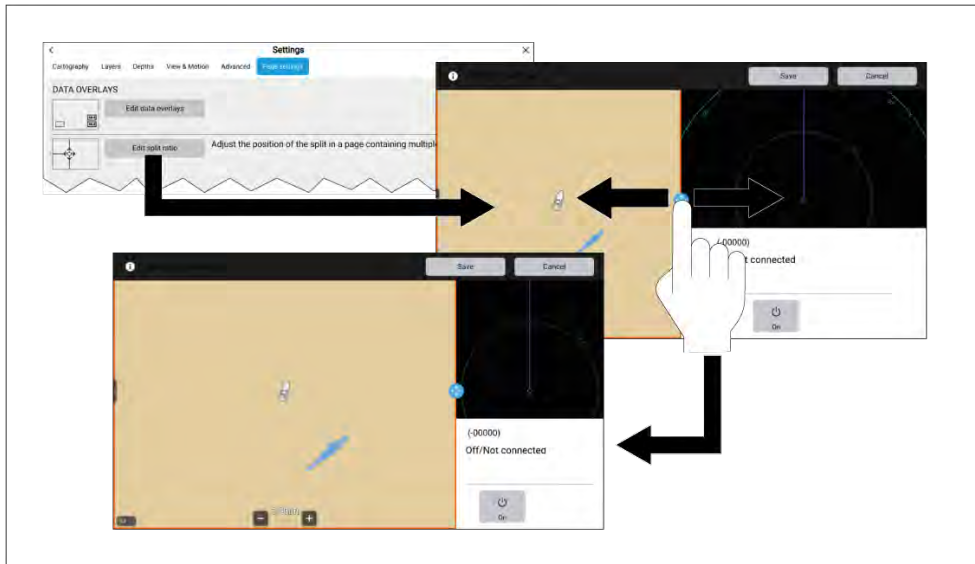

With a Splitscreen app page displayed:

1. Select *[Edit split ratio]* from the *[Page settings]* menu: *[Menu > Settings > Page settings > Edit split ratio.]*
2. Drag the Resize icon to create the desired split ratio.
3. Select *[Save]*.

6.6 Homescreen Dynamic tile

The app page icon used for the fullscreen Dashboard app on the homescreen can be changed to a *[Dynamic tile]*.

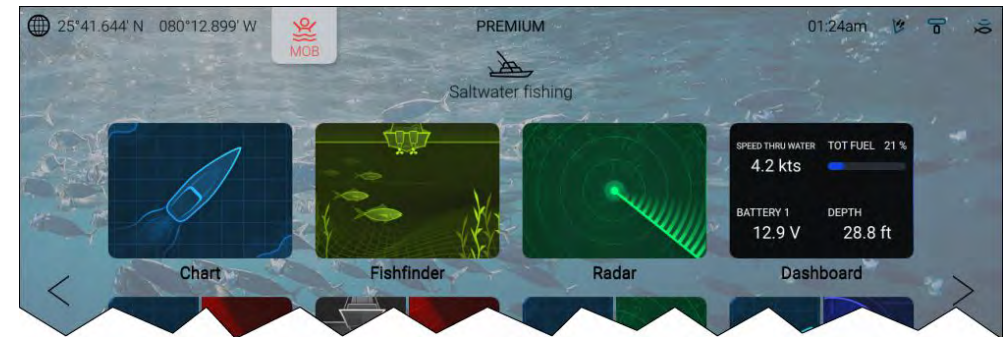

The *[Dynamic tile]* can display up to 4 live data items.

The *[Dynamic tile]* can be selected to open the Dashboard app.

To enable or customize a Dynamic tile, press and hold on a fullscreen Dashboard app page icon and use the pop-over options.

Enabling and configuring the Dynamic tile

You can enable and configure *[Dynamic tile]* by following the steps below.

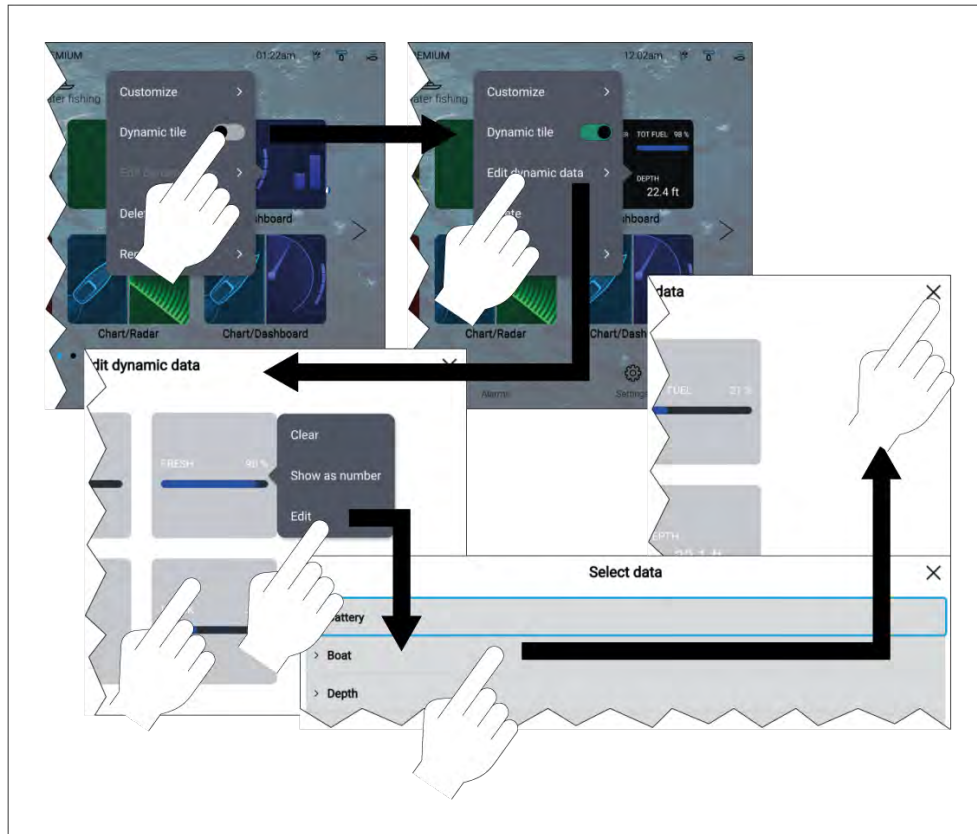

From the Homescreen:

1. Press and hold on the fullscreen Dashboard app page icon.
2. Enable the *[Dynamic tile]* toggle switch.
3. Select *[Edit dynamic data]*.
4. Select a data item.
5. Select *[Edit]* from the pop-over menu.
6. Select the type of data item you want to display.

The data items are sorted by number data items and graphical bar data items.

7. Select the relevant data item category and then select the data item.

Homescreen

8. Select the *[<]* (Back) or *[X]* (Close).
9. Follow steps 4 to 8 for each of the data items.
10. Select the *[<]* (Back) or *[X]* (Close) to return to the Homescreen.

6.7 Global positioning

Global Navigation Satellite System (GNSS) constellations

A GNSS constellation is a system of satellites that provides autonomous geospatial positioning that allows electronic devices with compatible receivers to determine their location (longitude, latitude and altitude).

Available GNSS constellations

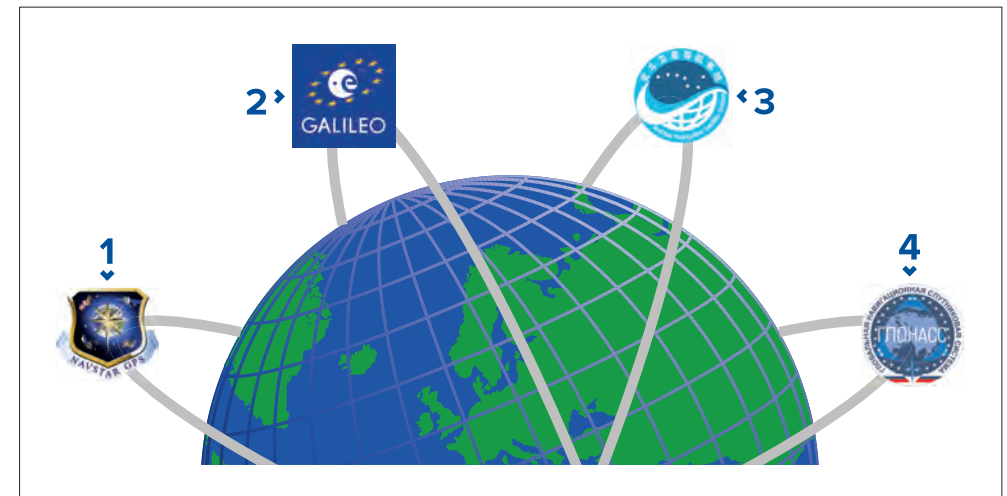

1. **GPS** — (NAVSTAR) Global Positioning System is the US owned constellation of satellites that became fully operational in 1995. GPS is the most widely used GNSS constellation and the term GPS has become synonymous with GNSS.
2. **Galileo** — EU owned satellite constellation that became fully operational in 2019.
3. **BeiDou** — Chinese Regional Navigation Satellite System, currently in its third generation, became fully operational in 2020.

4. **GLONASS** — (*GLO*balnaya *NA*avigatsionnaya *S*putnikovaya *S*istema" or "Global Navigation Satellite System") is the Russian owned constellation of satellites that has offered global coverage since 2010.

GNSS Constellations:

The GPS constellation (USA) is always enabled and cannot be disabled. The Galileo constellation can be enabled along with one other constellation. BeiDou and GLONASS cannot be enabled at the same time.

The GNSSs available are:

- *BeiDou* (China)
- *Galileo* (EU)
- *GLONASS* (Russia)

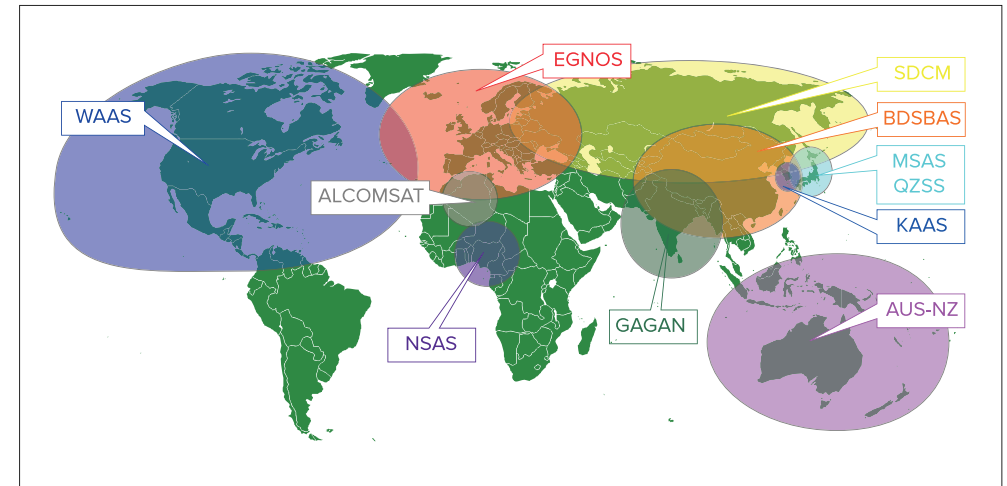

1. **ALCOMSAT** (Algeria)
2. **AUS-NZ** (Australia / New Zealand)
3. **BDSBAS** (China)
4. **EGNOS** (Europe)
5. **GAGAN** (India)
6. **KAAS** (Korea)
7. **MSAS** (Japan)
8. **NSAS** (Nigeria)
9. **SDCM** (Russia)
10. **WAAS** (USA)
11. **QZSS** (JAPAN)

Note:

GNSS constellation selection is only available when using a compatible GNSS (GPS) receiver. **Not all MFD and GNSS receiver variants support the same range of constellations:**

- For a list of compatible GNSS receivers refer to: [p.101 — GNSS constellation selection compatible receivers](#)
- For the settings available on incompatible receivers refer to: [GNSS settings for incompatible GNSS receivers](#)

Satellite based augmentation systems (SBAS)

Satellite based augmentation systems (SBAS) are systems that are used to complement existing GNSS by providing differential corrections that improve GNSS performance, including accuracy, availability and reliability.

The image below shows approximate coverage of the SBASs available on the MFD:

GNSS (GPS) Status

Your vessel's GNSS (GPS) position is displayed in the top left corner of the Homescreen. The status of the position fix and the satellites in use is displayed in the Fix menu.

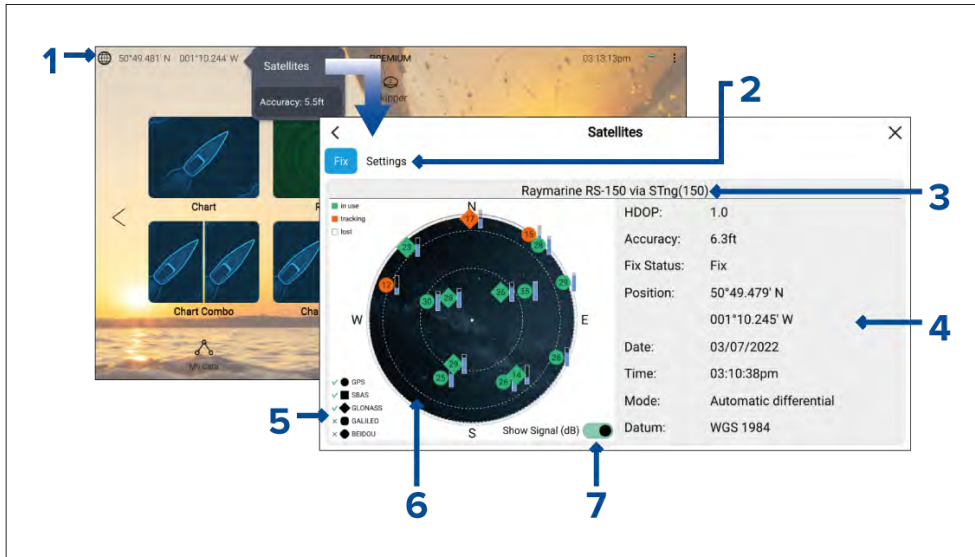

1. If latitude and longitude is displayed on the Homescreen, you have a valid position fix. If the text turns red, your fix accuracy is low. To access the *[Fix]* menu, select the Position details area on the Homescreen and then select *[Satellites]* from the Pop-over menu.
2. Select to access settings related to the GNSS (GPS) receiver.
3. The name of the GNSS (GPS) receiver currently being used to provide position data to the system is displayed centered at the top of the screen.
4. Position fix and fix accuracy data is displayed.

Note: When using a display's internal GNSS (GPS) receiver, only the Axiom[®]+, Axiom[®] Pro, Axiom[®] 2 Pro, Axiom[®] XL and Axiom[®] 2 XL show *Accuracy* information.

5. The shape of the satellite symbols identify which GNSS constellation they belong to.

Note: When using a compatible GNSS receiver, ticks are shown next to the symbols to indicate which constellations are currently selected for positioning. For a list of compatible GNSS receivers refer to: [p.101 – GNSS constellation selection compatible receivers](#)

6. The sky view on the left side of the page shows the position of navigation satellites. The color of the satellite identifies its status:
 - Green = satellite in use
 - Orange = tracking satellite (not currently used for position fix)
 - Gray = searching for satellites
7. The signal strength indicator for the satellites can be enabled and disabled using the *[Show Signal (dB)]* toggle switch.

GNSS settings

The settings for your GNSS (GPS) receiver (internal or external) can be accessed from the *[Satellites]* menu: *[Homescreen > GNSS pop-over > Satellites > Settings]*.

Settings displayed are for the GNSS (GPS) receiver currently in use. The name of the GNSS (GPS) receiver currently being used by the system is displayed in the *[Fix]* menu.

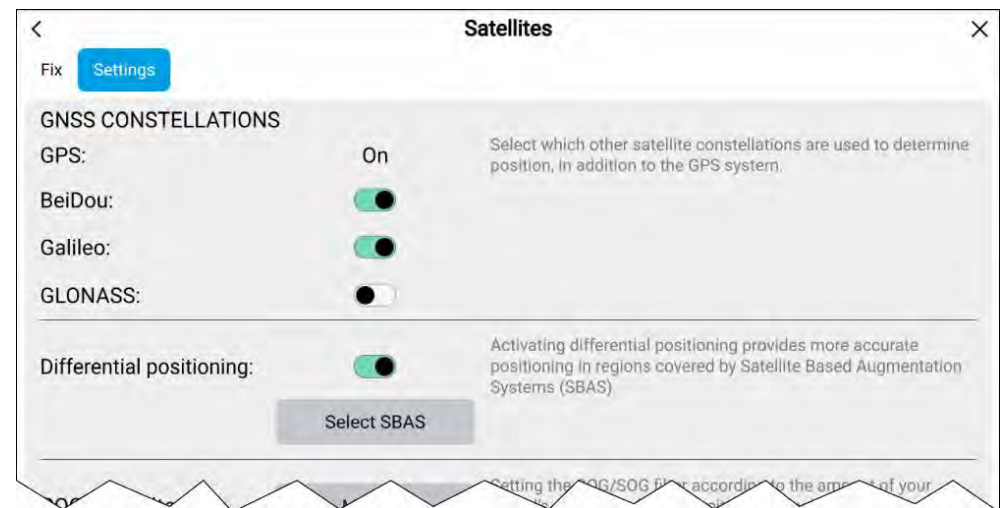

GNSS Constellations:

The GPS constellation (USA) is always enabled and cannot be disabled. The Galileo constellation can be enabled along with one other constellation. BeiDou and GLONASS cannot be enabled at the same time.

The GNSSs available are:

- *BeiDou* (China)
- *Galileo* (EU)
- *GLONASS* (Russia)

Note:

GNSS constellation selection options will be disabled 'grayed out' when using an incompatible GNSS (GPS) receiver.

- For a list of compatible GNSS receivers, refer to: [p.101 – GNSS constellation selection compatible receivers](#)
- For the settings available on incompatible receivers, refer to: [GNSS settings for incompatible GNSS receivers](#)

Differential positioning:

- Enable and disable the use of *[Differential positioning]* (SBAS) using the toggle switch. Enabling differential positioning provides more accurate positioning in regions covered by Satellite Based Augmentations Systems (SBAS).
- Select *[Select SBAS]* to view a list of supported SBASs used for differential positioning. The SBASs being used can be enabled and disabled using the relevant check boxes

Note:

SBAS selection options will be disabled 'grayed out' when using an incompatible GNSS receiver.

- For a list of compatible GNSS receivers, refer to: [p.101 – GNSS constellation selection compatible receivers](#)
- For the settings available on incompatible receivers, refer to: [GNSS settings for incompatible GNSS receivers](#)

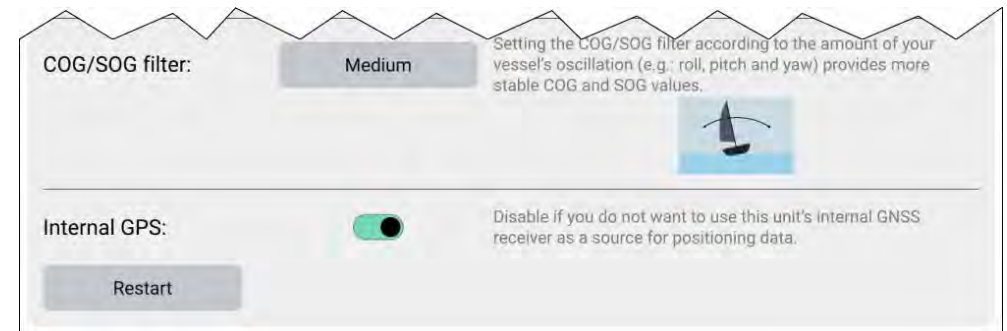

COG / SOG filter

Setting the COG / SOG filter according to the amount of your vessel's oscillation (e.g.: roll, pitch and yaw) provides more stable COG and SOG values.

The data reported by your GNSS receiver provides an instantaneous measure of the receiver's speed and direction. Under certain conditions the data can become erratic. (e.g.: a slow moving sailing vessel in rough seas will have a high oscillations and will benefit from a High setting, whereas a power boat that can quickly change speed and direction will have a low oscillation and will benefit from a low settings.)

The available options are:

- *High*
- *Medium (default)*
- *Low*

Note:

The filter does not affect your GNSS receiver's reported position.

Internal GPS

If applicable, you can enable and disable the MFD's internal receiver using the toggle switch.

Disable if you do not want to use the MFD's internal GNSS receiver as a source for positioning data.

For troubleshooting purposes you can also *[Restart]* the active GNSS receiver.

GNSS constellation selection compatible receivers

GNSS constellation selection and SBAS selection is only available on supported Raymarine GNSS receivers.

Compatible receivers

The following GNSS receivers support GNSS constellation selection and SBAS selection:

- Axiom®+ display's internal GNSS receiver running LightHouse™ version 4.0 or later or LightHouse™ version 3.14 or later.
- Axiom® Pro display's internal GNSS receiver running LightHouse™ version 4.0 or later or LightHouse™ version 3.14 or later.
- Axiom® XL display's internal GNSS receiver running LightHouse™ version 4.0 or later or LightHouse™ version 3.14 or later.
- Axiom® 2 Pro display's internal GNSS receiver running LightHouse™ version 4.3 or later.
- Axiom® 2 XL display's internal GNSS receiver running LightHouse™ version 4.4 or later.
- RS150 external GNSS receiver running software version 1.28 or above.
- YachtSense Link router's internal GNSS receiver.

Incompatible receivers

The following GNSS receivers do NOT support GNSS constellation selection and SBAS selection:

- Axiom™ display's internal GNSS receiver.
- Axiom®+ display's internal GNSS receiver running LightHouse™ version 3.13 or below.
- Axiom® Pro display's internal GNSS receiver running LightHouse™ version 3.13 or below.
- Axiom® XL display's internal GNSS receiver running LightHouse™ version 3.13 or below.
- RS150 external GNSS receiver running software below version 1.28.
- AR200 Augmented reality sensor.

GNSS settings for incompatible GNSS receivers

Available settings when using a GNSS receiver that does NOT support GNSS constellation selection and SBAS selection.

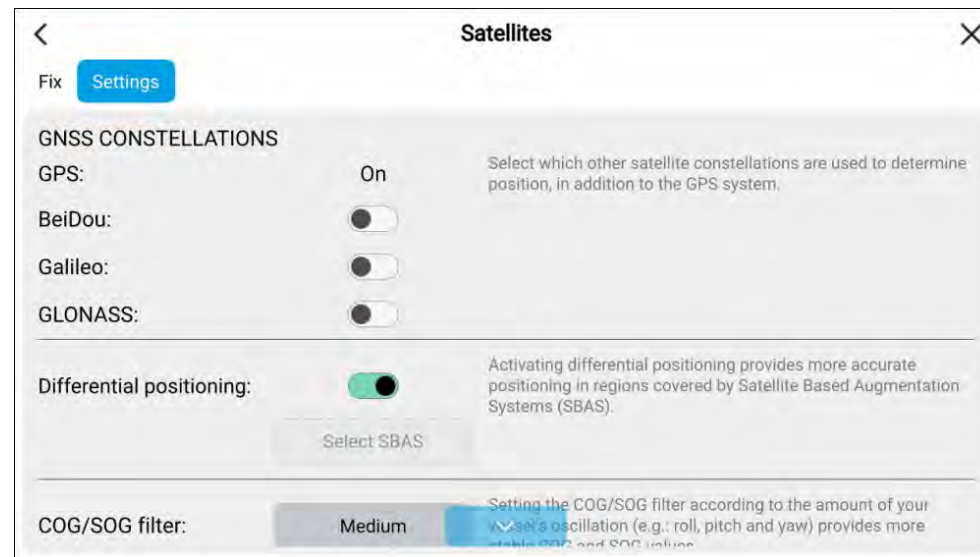

Note:

GNSS constellation selection is not supported and the options will be disabled when using an incompatible GNSS receiver.

Differential positioning:

- Enable and disable the use of *[Differential positioning]* (SBAS) using the toggle switch. Enabling differential positioning provides more accurate positioning in regions covered by Satellite Based Augmentations Systems (SBAS).

Note:

Differential positioning can be enabled and disabled, but individual SBAS selection is not supported. The option will be disabled when using an incompatible GNSS receiver.

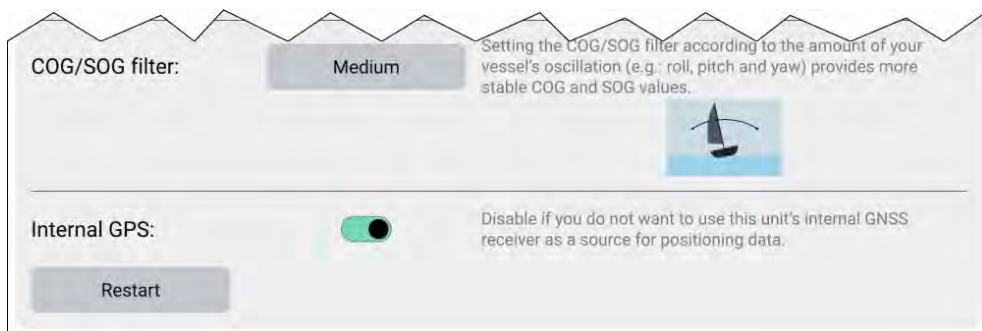

COG / SOG filter

Setting the COG / SOG filter according to the amount of your vessel's oscillation (e.g.: roll, pitch and yaw) provides more stable COG and SOG values.

The data reported by your GNSS receiver provides an instantaneous measure of the receiver's speed and direction. Under certain conditions, the data can become erratic. For example, a slow moving sailing vessel in rough seas will have a high oscillation, and will benefit from a *[High]* setting, whereas a power boat that can quickly change speed and direction will have a low oscillation and will benefit from a *[Low]* setting.

The available options are:

- *High*
- *Medium (default)*
- *Low*

Note:

The filter does not affect your GNSS receiver's reported position.

Internal GPS

If applicable, you can enable and disable the MFD's internal GNSS receiver using the toggle switch.

Disable if you do not want to use the MFD's internal GNSS receiver as a source for positioning data.

For troubleshooting purposes you can also *[Restart]* the active GNSS receiver.

6.8 Status area

You can view the status of certain connected devices using the MFD's Status area, located at the top right of the Homescreen. The status area also includes the *[Time]* received from an internal or external GNSS receiver, and identifies when an Axiom™ Pro MFD is in *[Touchlock]* mode.

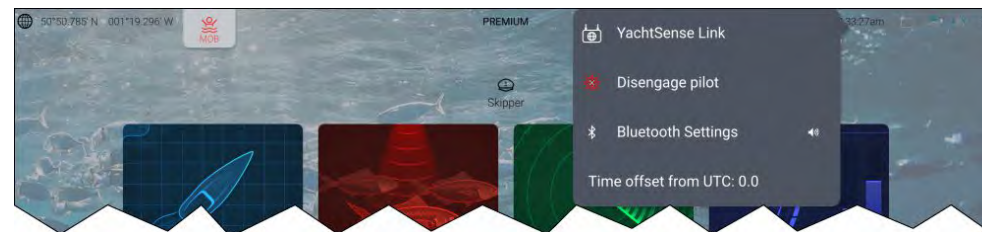

Device status

The status of the following devices is shown in the status area: Autopilot, AIS, Radar, Sonar transducer, YachtSense Link router, and Bluetooth connection.

Pop-over menu options

From the pop-over menu the following options are available:



- *[YachtSense Link]*— Select to access the YachtSense Link router's user interface.
- *[Disengage pilot]*— Select to disengage your autopilot.
- *[Bluetooth Settings]*— Select to access Bluetooth connection settings. Select the speaker icon to access Bluetooth volume controls.
- *[Time offset from UTC]*— Select to adjust the Time offset from UTC.

MFDs that are configured using the *First Responder* boating activity include additional *[AIS mode]* and *[SITREP]* options, and also provide Data logging status. For details, refer to: [p.359 — First Responder](#)



Status area icons

The icons displayed in the Status area signify the current status of certain connected devices.

YachtSense™ Link

Icon	Status	Icon	Status
	YachtSense™ Link connected		YachtSense™ Link connected and internet available.

AIS

Icon	Status	Icon	Status
	AIS transmitting and receiving		AIS receive only (e.g. Silent Mode)
	AIS Error		



Note:

The First responder boating activity profile includes an additional AIS icon. For details refer to: [p.359 – First responder](#)



Autopilot

Icon	Status	Icon	Status
	Autopilot engaged		



Bluetooth

Icon	Status	Icon	Status
	Bluetooth on / not connected		Bluetooth connected / paired

Radar

Icon	Status	Icon	Status
	Radar transmitting		Radar standby
	Radar error		

Sonar / Transducer

Icon	Status	Icon	Status
	Sonar pinging		Sonar not pinging
	Sonar error		

Touchlock

Icon	Status	Icon	Status
	Touchlock active		

Note:

The First responder boating activity profile also includes Data logging status icons. For details refer to: [p.359 — First responder](#)

6.9 My data

Selecting *[My data]* from the homescreen provides access to user data such as waypoints, routes and tracks. You can also access the fuel manager, file browser and the data import and exports settings.



1. *[Waypoints]*— Select to access the waypoints list to manage your waypoints.

2. *[Routes]*— Select to access the routes list to manage your routes.
3. *[Tracks]*— Select to access the tracks list to manage your tracks.
4. *[Fuel/Trip]*— Select to access and set up the fuel manager and view trip data.
5. *[Files]*— Select to access the file browser.
6. *[Mobile sync]*— Select to cancel synchronisation with the Raymarine app.
7. *[Import/export]*— Select to access back up and restore settings.
8. *[Eject SD card]*— Select before ejecting a memory card to ensure it is removed safely.

Note:

MFDs configured with the First responder boating activity profile include a Messages icon on the My data page which allows access to the Messages app. For details refer to: [p.384 — Messaging app](#)

The Messages app also requires STEDS compatible AIS hardware.

Related topics:

- [p.253 — Navigate mode main menu](#)
- [p.255 — Fishing chart mode main menu](#)
- [p.286 — Racing mode main menu](#)
- [p.259 — Fish mapping mode main menu](#)

Fuel/trip manager

The fuel/trip manager collects trip data automatically based on distance travelled and provides an estimate of how much fuel you have remaining based on user inputted fuel refill data.

The Fuel/trip manager can be accessed by selecting *[Fuel/Trip]* from the *[My Data]* page: *[Homescreen > My Data > Fuel/Trip]*.



1. Estimated fuel remaining
2. *[Set all tanks full]*— Select when you have filled up all tanks.
3. *[Add partial fuel fill]*— Select to enter a specific volume of fuel during a partial tank fill.

Note: If you enter the wrong amount of fuel this can be corrected by entering a minus value as a partial fuel fill, this will reduce the total amount of fuel remaining by the amount entered.

4. Trip (Manual) — accumulates data until reset.
5. Trip (Day) — resets automatically when local time passes midnight.
6. Trip (Month) — resets automatically on the 1st day of the month.
7. Trip (Season) — accumulates data until reset.
8. *[Reset trip]*— The *[Trip (Manual)]* and *[Trip (Season)]* logs can be reset by selecting the relevant *[Reset Trip]* button.

Note:

- The Fuel manager estimates the amount of fuel remaining onboard based on logging each time you fill up, your vessel's total fuel capacity, and how much fuel is burned by your engine(s). Incorrect entries will affect the fuel calculations which could result in a shortage of fuel.
- The Fuel remaining calculation is an estimate and will be inaccurate if fuel fills are not entered, entered incorrectly, or if fuel is used by other sources (e.g.: generators).
- Distance to Empty and Time to Empty values are based on estimated fuel remaining calculations which do not take into account the effects of weather and tide on fuel usage.
- This system is not a substitute for other fuel calculations. You should not rely on the Fuel manager calculations for accurate voyage planning or in emergency and safety critical situations.

Fuel set up

The fuel manager can be enabled and configured from the *[Fuel set up]* menu.

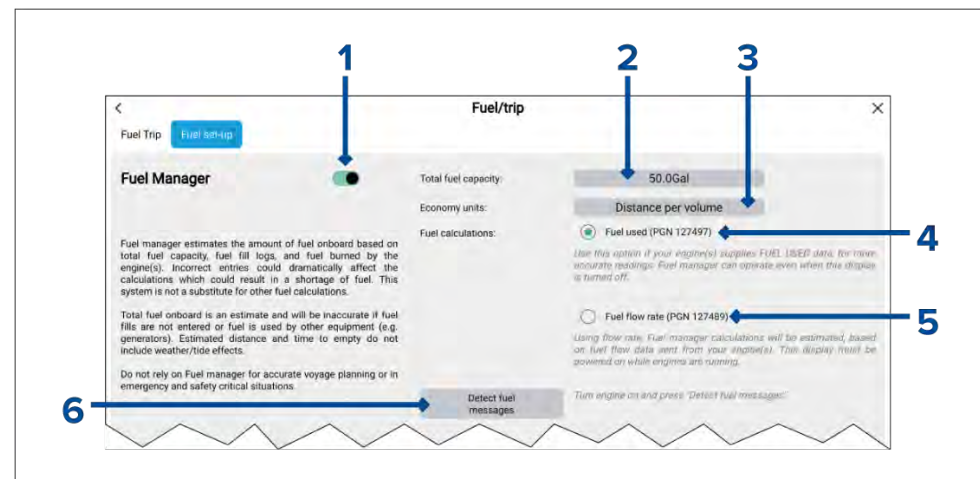

1. *[Fuel Manager]*— Select to enable or disable the fuel manager.
2. *[Total fuel capacity]*— Sum of total capacity of all your fuel tanks.
3. *[Economy units]*— Economy units used in data overlays, Side bars or the Dashboard app.

4. *[Fuel used (PGN 127497)]*— Use this option if your engine(s) supply Fuel used data. When Fuel used is selected the Fuel manager will continue to operate when the MFD is switched off. This option usually provides more accurate readings.
5. *[Fuel flow rate (PGN 127489)]*— this option estimates fuel calculations based on fuel flow rate data sent by your engine(s). Your MFD must remain switched on, whilst engines are running.
6. *[Detect fuel messages]*— If you are unsure which engine messages your engine provides, select this option to determine the correct message.

Setting up the fuel manager

To start using the fuel manager you must first specify the total capacity of your fuel tanks, and then fill the tanks to set a reference level for the fuel manager.

From the *[Fuel set-up]* page: *[Homescreen > My Data > Fuel/Trip > Fuel set-up]*.

1. Select the box next to *[Total fuel capacity:]* and enter the total capacity of all of your fuel tanks.
2. Select the *[Fuel manager]* toggle switch to enable the fuel manager.
3. Select the box next to *[Economy units:]* and select either: *Distance per volume*, *Volume per distance*, or *Litres per 100km*.
4. Select either *[Fuel used (PGN 127497)]* or *[Fuel flow rate (PGN 127489)]*. If you are unsure, select *[Detect fuel messages]* to detect which messages are available to your MFD.
5. Fill up your fuel tanks.
6. Once the tanks are full, select *[Set all tanks full]* from the *[Fuel Trip]* menu.
7. Log each subsequent fuel fill whether partial or full.

Files

The file browser can be used to *[Open]* and *[Delete]* photos / images and PDF documents, saved to external storage, and can also be used to *[Import]* or *[Delete]* user data and MFD settings files) saved to external storage.

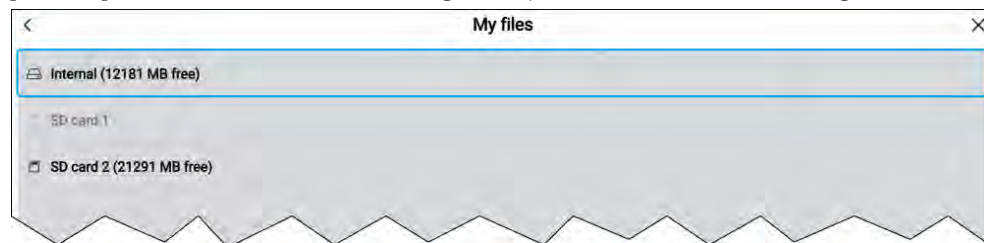

Selecting a storage device expands its contents, allowing you to browse the contents.

The following file type can be viewed:

- **PDF files** — Selecting a PDF document will open a pop-over menu where you can choose to *[Open]* or *[Delete]* the file.
- **Image files** — Selecting an image file will open a pop-over menu where you can choose to *[Open]* or *[Delete]* the file.
- **Video files** — Selecting an MPEG4 video file will open a pop-over menu where you can choose to *[Open]* or *[Delete]* the file.
- **gpx** — Selecting a gpx file (user data file which can contain waypoint, routes and tracks) will open a pop-over menu where you can choose to *[Import]* or *[Delete]* the file.
- **lh3** — Selecting a lh3 (MFD settings backup) file will open a pop-over menu where you can choose to *[Restore]* or *[Delete]* the file.
- **Lighthouse_id.txt** — Selecting the Lighthouse_id.txt file will open a pop-over where you can *[Open]* the file so that you can scan the QR code when installing LightHouse Charts via the Raymarine app.
- **apk** — Android apk apps downloaded from the Raymarine website can be installed from the file browser.

Note:

Only file types that are supported by your MFD will be visible in the browser.

Import/export

User data and MFD settings can be imported and exported from your MFD. User data (Waypoint, Routes and Tracks) is saved in the common .gpx file format. MFD settings will be saved in .lh3 format.

The Import/export page can be accessed from the My data page: *[Homescreen > My data > Import/export]*.

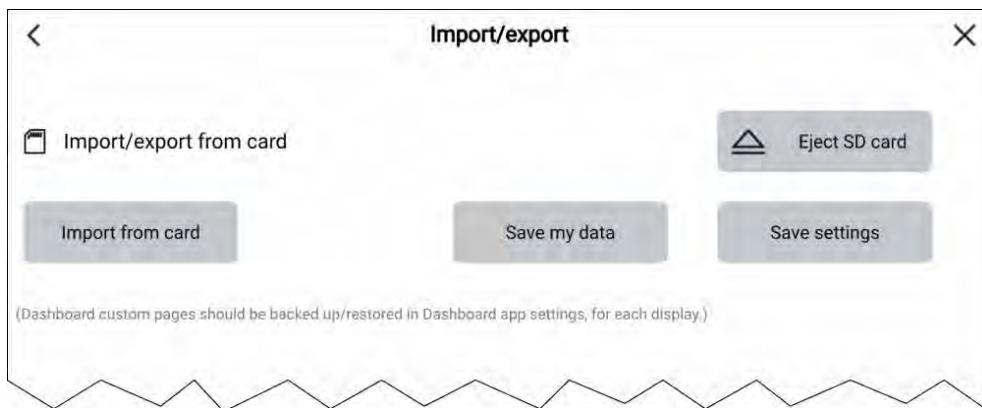

Saving user data

You can backup your user data (waypoints, routes and tracks) to a MicroSD card.

Note:

The LightHouse 3 and LightHouse 4 operating systems allow multiple waypoints to be created with the same waypoint name. If you intend to import the saved waypoints to a different system ensure that all waypoint names are unique or that the system you are importing them onto supports non-unique waypoint names.

Example: If more than 1 waypoint with the same waypoint name is imported into a LightHouse 2 MFD only 1 waypoint with that waypoint name will be imported as the LightHouse 2 operating system requires waypoint names to be unique.

1. Insert a memory card into your display's card reader.
2. Select *[Save my data]* from the *[Import/export]* page: *[Homescreen > My data > Import/export]*.
A pop-over menu is displayed.
3. Select the desired option:
 - *[Save all data]* to save (export) all waypoints, routes and tracks.
 - *[Save waypoints]* to save (export) all waypoints.
 - *[Save routes]* to save (export) all routes.
 - *[Save tracks]* to save (export) all tracks.

4. Select the relevant card slot from the Info dialog, or for display's with only 1 card reader slot select *[Save]*.
5. Select *[Save]* to accept the default filename, or use the onscreen keyboard to enter your own filename and then select *[Save]*.
6. Select *[OK]* to return to the Import/export page, or select *[Eject card]* to safely remove the memory card.

The user data file is saved to the 'Raymarine\My Data' directory of your memory card in gpx format.

Saving display settings

You can backup your display's settings to memory card.

Important:

- Saving your display settings will also save any new or customized dashboard pages.
- Digital switching dashboard pages will not be saved when saving your display's settings.

1. Insert a memory card into your display's card reader.
2. Select *[Save settings]* from the *[Import/export]* page: *[Homescreen > My data > Import/export]*.
3. Select the relevant card slot from the Info dialog, or for display's with only 1 card reader slot select *[Save]*.
4. Select *[Save]* to accept the default filename, or use the onscreen keyboard to enter your own filename and then select *[Save]*.
5. Select *[OK]* to return to the Import/export page, or select *[Eject card]* to safely remove the memory card.

The settings file is saved to the 'Raymarine\My Data' directory of your memory card with a .lh3 file extension.

Importing user data or settings from a memory card

You can restore user data (waypoints, routes and tracks) and settings that have been exported to a memory card.

Important:

- Restoring your settings will also restore any new or customized Dashboard app pages.
- Digital switching Dashboard app pages will not be restored when importing your settings. The original configuration will need to be re-installed..

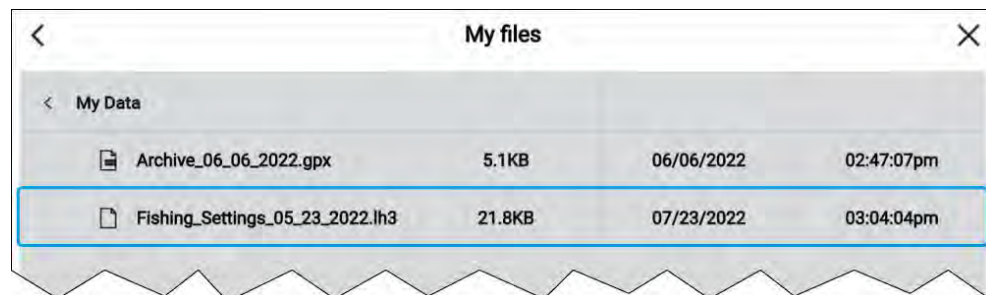

1. Insert the memory card containing your saved data into a card reader slot.
2. Select *[Import from card]* from the Import/export page: *[Homescreen > My data > Import/export]*.
The file browser is displayed
3. Navigate to the gpx or lh3 file that you want to import.

User data and settings files will be located in the |Raymarine|My Data| folder on your memory card.

4. Select the file.
The import process will start.
5. If importing a gpx file, select *[OK]* when complete.
6. If importing settings, select *[Yes]* to confirm the settings restore.

Your MFD will reboot to complete the process.

6.10 My profiles

You can share your MFD with other users by creating user profiles on your MFD. Profiles enable you to retain your own personal settings whilst letting other users personalize the MFD's settings to their preference.

Note:

User data such as waypoints, routes, tracks, images and video recordings etc. will be available to all users, and are shared by all users. This means that, for example, if you add or delete a waypoint while using one user profile, the change will also be reflected in all other profiles on the MFD, including demo profiles.

You can access the profiles page by selecting the profile icon on the homescreen.

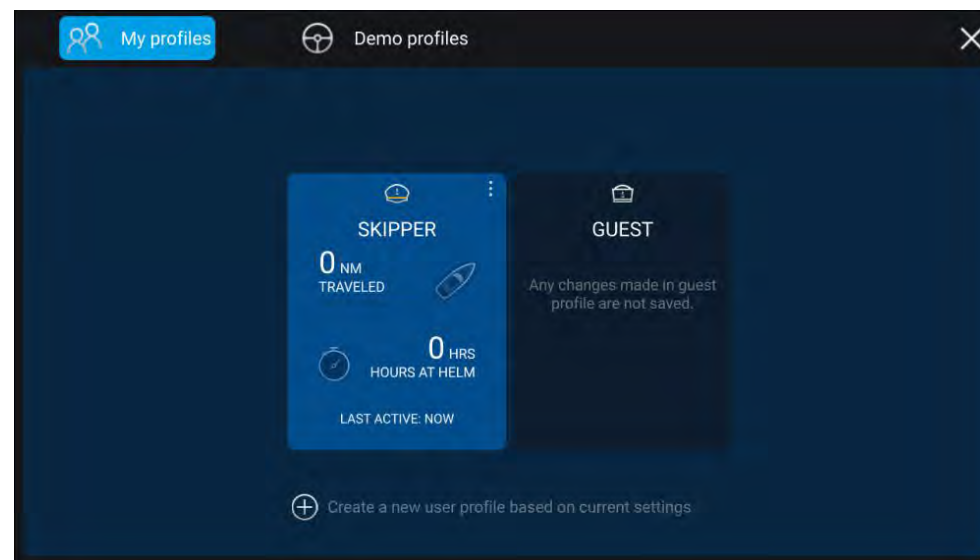

Selecting the *[+]*(plus) icon will create a new profile based on the profile that is currently in use.

MFD settings changes are unique to the profile in use and are retained the next time the profile is used.

The distance and time that a profile has been active is displayed for each profile.

Profile names and icons can be customized. You can also reset the distance and time for each profile.

A Guest profile is available for temporary users. Setting changes to the Guest profile are not retained. Each time the guest profile is activated the settings are based on the last used profile.

When the MFD is rebooted the last used profile will be active.

Demo profiles are also available to help you practice operating your MFD with simulated data.

Demo profiles

Profiles are available for simulation and demonstration purposes. A demo movie, stored on external storage, can also be set to play when a demo profile is activated and inactivity has been detected for 60 seconds.

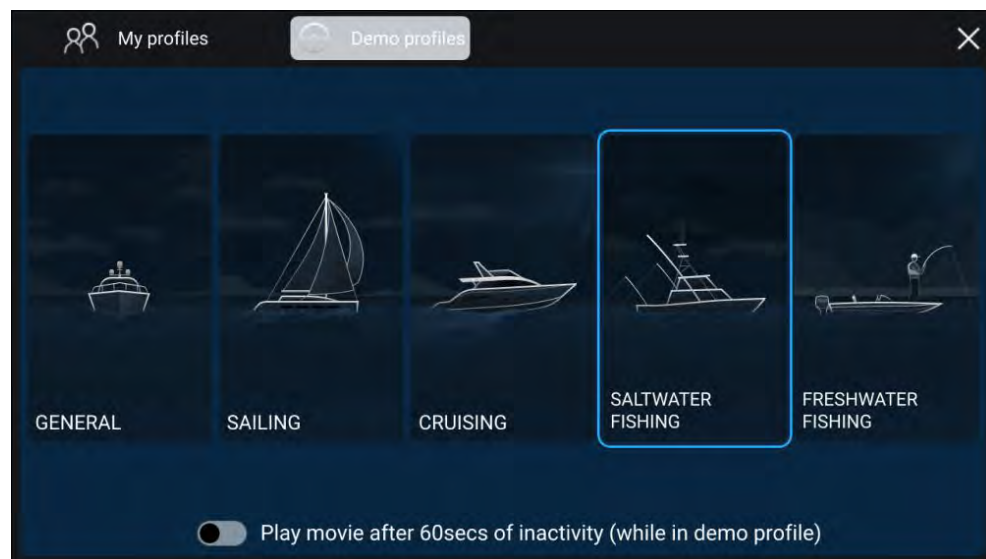

Selecting a demo profile will provide your MFD with simulated data to help you practice operating your display.

Important:

- It is recommended that demo profiles are NOT activated whilst navigating.
- User **data** such as waypoints, routes, and tracks is shared with all the other user profiles on the MFD. This means that, for example, if you add or delete a waypoint while using a demo profile, the change will also be reflected in all other user profiles on the MFD.
- Demo profiles will NOT display any real data, including safety warnings and messages.
- Any **settings** changes made will not affect User profiles.

Demo movie requirements

A demo movie file can be set to play when a demo profile is active and the MFD has not been used for 60 seconds.

Demo movie files must be in the .mov file format and encoded using the H.264 video codec standard. The Demo movie files must be saved to an external storage device connected to the MFD. Demo movies are not shared across networked MFDs.

When the Demo movie feature is activated the system will search for a demo movie file associated with the active demo profile. If an associated file cannot be found then the generic demo.mov is played. See below for filename details.

Demo profile	Associated filename
[General]	demo_general.mov
[Sailing]	demo_sailing.mov
[Cruising]	demo_cruising.mov
[Saltwater fishing]	demo_salt.mov
[Freshwater fishing]	demo_fresh.mov
Plays in all demo profiles if an associated demo file is not found.	demo.mov

If an MFD is powered off with the demo movie active then the next time the MFD is powered on the demo movie will play immediately after boot up.

Any interaction with the Touchscreen or physical buttons will stop the movie playing and return you to the active demo profile.

CHAPTER 7: SETTINGS

CHAPTER CONTENTS

- 7.1 Homescreen settings menus — page 111
- 7.2 Selecting display language — page 112
- 7.3 Boat details — page 112
- 7.4 Battery configuration — page 114
- 7.5 Generator configuration — page 114
- 7.6 Tanks — page 115
- 7.7 Calibrating tanks — page 116
- 7.8 Setting fuel tanks as not for propulsion — page 117
- 7.9 Units settings menu — page 118
- 7.10 Splashscreen and background images — page 119
- 7.11 Shared Brightness — page 121
- 7.12 Datamaster — page 122
- 7.13 Switching off sensor LEDs — page 122
- 7.14 Find me — page 123
- 7.15 IP device user interface access — page 123
- 7.16 Connecting to a wireless display — page 124
- 7.17 NMEA 0183 settings — page 125

7.1 Homescreen settings menus

The display's settings are accessed by selecting the *[Settings]* icon located at the bottom of the Homescreen.

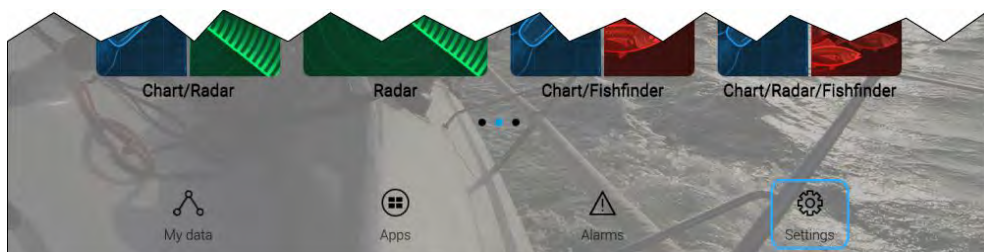

The *[Settings]* are divided into different menus which can be accessed by selecting the tabs at the top of the screen. The following menus are available:

Menu	Settings
<i>[Getting started]</i>	<ul style="list-style-type: none"> • View hardware and software information about your MFD. • Update MFD software • View the terms of use disclaimer. • View the Regulatory approvals. • Change the user interface language. • Select Homescreen icon types.
<i>[Boat details]</i>	<ul style="list-style-type: none"> • Set boat icon and name. • Configure Sailing features (Sailing vessels only). • Configure Minimum safe depth, height and width. • Add distances for anchoring mode. • Configure engines. • Configure batteries. • Configure generators. • Configure fuel tanks. • Configure environment sensors.

Menu	Settings
<i>[Units]</i>	<ul style="list-style-type: none"> • Configure preferred units of measurement. • Configure Bearing mode. • Configure variation. • Configure GNSS (GPS) system datum. • Set time differentials for Loran-C.
<i>[This display]</i>	<ul style="list-style-type: none"> • Color theme (day mode). • Assign a Homescreen page or app to start on power up. • Select save location for screenshots. • User Configurable key(s) (Axiom® Pro and Axiom® 2 Pro displays only). • Keypad type selection (Axiom® 2 Pro displays only). • Configure Shared Brightness. • Configure helm grouping for Mercury® VesselView integration. • Change or reset splashscreen graphic. • Change or reset homescreen background image. • Pair / unpair connected RMK external keypads. • Enable / disable external alarm output. (Axiom® XL and Axiom® 2 XL displays only). • Connect to a wireless display. • Configure Wi-Fi Sharing, pair with a wireless Quantum Radar scanner, configure Wi-Fi settings and set up mobile app access. • Connect to a Bluetooth device. • Perform a Settings or Factory reset.

Menu	Settings
[Autopilot]	<ul style="list-style-type: none"> • Enable / Disable Autopilot control. • Set autopilot response. • Access advanced autopilot settings. • Configure route automatic turn.
[Network]	<ul style="list-style-type: none"> • View list of networked MFDs. • Assign the MFD datamaster. • View software and network details for the MFD you are using. • Rename connected network devices. • Save or Erase diagnostics logs to external storage. • View and Save Diagnostic information about products connected to your MFD. • Enable Sonar recording for troubleshooting purposes. • Set up NMEA 0183 options on an Axiom Pro. • Assign your preferred data sources (datamaster only). • Refresh network list. • Enable and disable the MFD's DHCP server. • Keep the display's network connections active when the display is in standby (Axiom® 2 displays only).
[Responder]	<p>The Responder menu tab is only available when [First responder] is selected as the 'Boating activity' during step 2 of the MFD's initial startup wizard. The Responder menu includes settings for STEDS-specific features, which require an AIS5000 to be connected to the system. For details, refer to: p.360 – First responder features</p>

7.2 Selecting display language

You can choose which language you want the display's user interface to use.

1. Select the [Language] button from the [Getting started] menu:
[Homescreen > Settings > Getting started > Language:].

2. Select your desired language.

Languages

The following user interface languages are available:

Arabic (ar-AE)	Bulgarian (bg-BG)	Chinese (Simplified) (zh-CN)	Chinese (Traditional) (zh-TW)
Croatian (hr-HR)	Czech (cs-CZ)	Danish (da-DK)	Dutch (nl-NL)
English (en-GB)	English (en-US)	Estonian (et-EE)	Finnish (fi-FI)
French (fr-FR)	German (de-DE)	Greek (el-GR)	Hebrew (he-IL)
Hungarian (he-IL)	Icelandic (is-IS)	Indonesian (Bahasa) (id-ID)	Italian (it-IT)
Japanese (ja-JP)	Korean (ko-KR)	Latvian (lv-LV)	Lithuanian (lt-LT)
Malay (Bahasa) (ms-MY ZSM)	Norwegian (nb-NO)	Polish (pl-PL)	Portuguese (Brazilian) (pt-BR)
Russian (ru-RU)	Slovenian (sl-SI)	Spanish (es-ES)	Swedish (sv-SE)
Thai (th-TH)	Turkish (tr-TR)	Vietnamese (vi-VN)	

The selected language also determines the display's default units of measure.

7.3 Boat details

LightHouse 4 can be configured with the specific characteristics of your vessel. To ensure correct operation and display of vessel data, you should provide your relevant vessel details, as described below.

Boat details can be accessed from the [Settings] menu: [Homescreen > Settings > Boat Details]

Option	Description
[Boat type:]	<p>Selection determines the icon used to represent your vessel's position in the Chart app.</p> <p>Note:</p> <p>When the MFD is using the Sailing boating activity, selecting one of the sailing vessels can also improve accuracy of leeway calculations.</p>
[Boat Name:]	Configures your system with your vessel's name.
[Sail performance:]	<p>The following options are available:</p> <ul style="list-style-type: none"> • <i>Mirrored TWA (default)</i> • <i>Fixed Angles</i> • <i>Polar</i> <p>Note:</p> <p>The [Sail performance] option is only available when the <i>Sailing</i> activity has been selected during the display's initial startup wizard.</p> <p>For further details refer to: p.286 – Laylines</p>
[Upwind angle:]	This setting is available when the <i>Fixed Angles</i> Sail performance setting has been selected, and allows you to specify the fixed angle for upwind layline calculations.
[Downwind angle:]	This setting is available when the <i>Fixed Angles</i> Sail performance setting has been selected, and allows you to specify the fixed angle for downwind layline calculations.
[Polar:]	This setting is available when the <i>Polar</i> Sail performance setting has been selected, and allows you to select a polar table, or import your own polar table. For more information on Polars, refer to: p.289 – Polar laylines

Option	Description
[Sail plan:]	<p>This setting allows you to import and manage sail plans. For details, refer to: p.294 – Sail plan recommendations</p> <p>Note:</p> <p>The [Sail plan] option is only available when the <i>Sailing</i> activity has been selected during the display's initial startup wizard.</p>
[Min safe height:]	Enter your vessel's maximum unladen height from the waterline. To ensure adequate clearance, it is recommended that you add a safety margin to this figure to allow for variation caused by vessel movements.
[Min safe width:]	Enter your vessel's maximum width at its widest point. To ensure adequate clearance on both sides, it is recommended that you add a safety margin for port and starboard to this figure to allow for variation caused by vessel movements.
[Min safe depth:]	Enter your vessel's maximum depth when fully laden. This is the depth from the waterline to the lowest point on the vessel's keel. To ensure adequate clearance, it is recommended that you add a safety margin to this figure to allow for variation caused by vessel movements.
[Boat length:]	Enter your vessel's length from bow to stern. Boat length is used for Anchor mode and the Anchor drag alarm in the Chart app.
[Bow to GPS:]	Enter the distance that your GNSS (GPS) receiver is from your vessel's bow. This measurements is used in Anchor mode and the Anchor drag alarm in the Chart app.
[Num of engines:]	Select the number of engines on your vessel. When connected to a compatible system, your MFD can monitor engine data.
[Identify engines:]	Once you have selected the number of engines, select [Identify engines] and follow the onscreen instructions to configure your engines. May require an extra hardware interface to enable engine data to be displayed.

Option	Description
[Engine manufacturer:]	To interface with [Yamaha], [Yamaha HDMII] and [Mercury] gateways, select the relevant manufacturer from the list. Otherwise, select [Other].
[[Num of engines 2 only]] [Configure Yamaha Quad display:]	Select whether your MFD is displaying engine data for a twin engine system, or for the port or starboard side of a quad engine system.
[Num of batteries:]	Configures detected batteries.
[Num of generators:]	Configures detected generators.
[Tanks:]	Calibrate your vessel's tanks.
[Num of interior environment sensors:]	Allows the display of interior temperature and humidity data from multiple sensors. Up to 10 sensors can be used.

7.4 Battery configuration

The MFD will automatically detect the number of batteries in your system when the information is transmitted using standard NMEA 2000 PGNs 127506 & 127508, or via other supported systems. Detected batteries can be viewed and customized from the battery configuration table.

The battery configuration table can be accessed from the [Boat details] settings menu: [Homescreen > Settings > Boat details > Configure batteries].

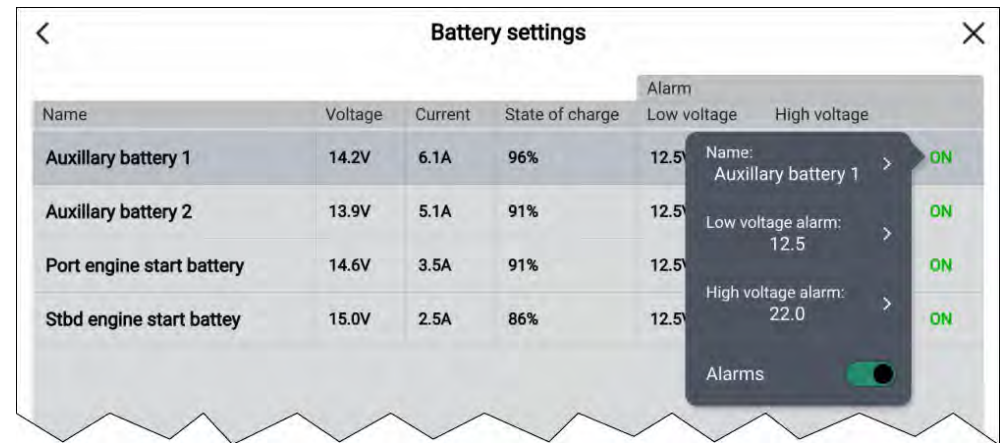

The battery configuration table lists all detected batteries and provide details and status for each. Default battery names are based on device name plus battery number (instance).

Selecting a battery from the table displays a pop-over menu where you can rename or set up a low and high voltage alarm for the selected battery. Changed battery names will appear in battery data items for sidebars, Dashboard app and app data overlays.

The battery configuration table can also be accessed from the alarms settings: [Homescreen > Alarms > Settings > Configure batteries].

7.5 Generator configuration

The display will automatically detect compatible generators.

Before a generator can transmit data to a Raymarine multifunction display, it must be:

- connected to the same SeaTalkng[®]/NMEA 2000 network as the display (typically, via the generator manufacturer's NMEA 2000 interface/gateway, which must be running an appropriate software version — refer to the generator manufacturer), and:
- transmit the supported NMEA 2000 PGNs onto the same SeaTalkng[®]/NMEA 2000 network.

For information on compatible interfaces, refer to your generator's manufacturer.

Note:

Each generator/generator’s NMEA 2000 interface must be configured with an instance number that is unique to the boat system to which it is connected. For example, if an interface uses the same instance number as a propulsion engine, there will be a data conflict. In this case, refer to the generator manufacturer for advice on configuring instance numbers, if necessary.

Detected generators can be viewed by selecting *[Configure generators]* from the *[Boat details]* settings menu: *[Homescreen > Settings > Boat details > Configure Generators]*.

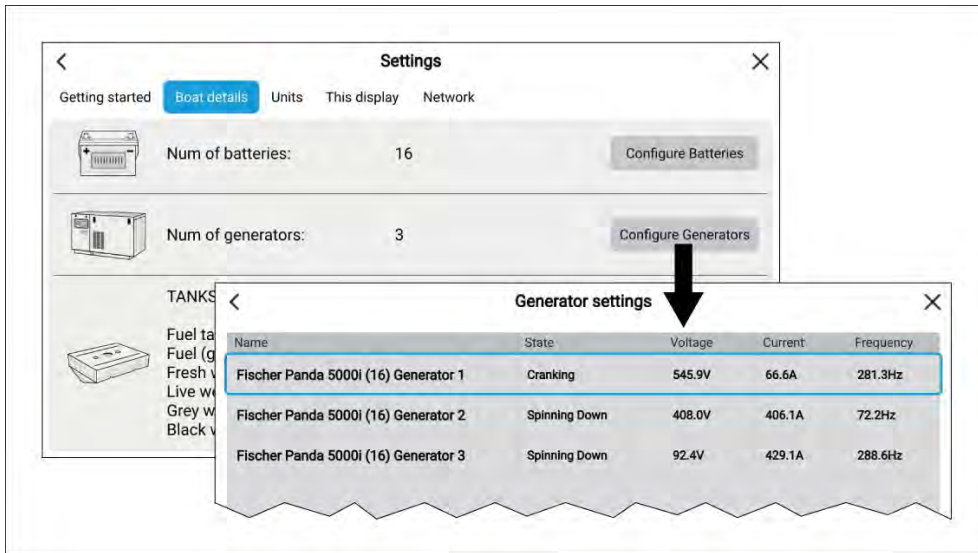

The generator name is derived automatically by the generator interface. You can rename each generator to give it a more appropriate name by selecting a generator from the list and then selecting the *[Name:]* option from the pop-over menu.

Generators that are no longer detected can be removed from the list by selecting the **Not found** generator and selecting *[Remove]* from the pop-over menu.

Detailed data for generators can be viewed on pre-configured pages in the Dashboard app. For details, refer to: [p.404 – Generators page](#)

7.6 Tanks

The MFD can monitor the status of vessel tanks that use a compatible tank sender or have a compatible tank sender adaptor fitted.

The following types of tank can be monitored:

- Fuel tanks — up to 5 tanks
- Fuel (gasoline) tanks — up to 2 tanks
- Fresh water tanks — up to 2 tanks
- Live well tanks — up to 2 tanks
- Grey water tanks — up to 2 tanks
- Black water tanks — up to 2 tanks

Important:

The number of each tank should be selected during step 3 of the MFD’s initial start up wizard.

The number of each type of tank can be viewed from the Boat details settings menu. Selecting *[Configure Tanks]* will display a list of all detected tanks.

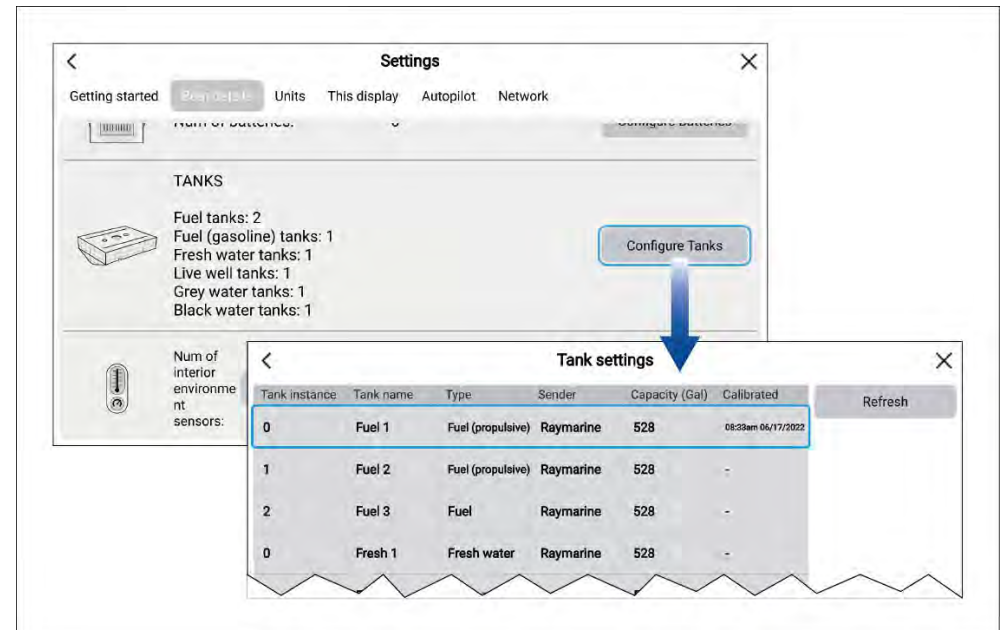

The details shown in the list of tanks are automatically detected.

Note:

If the number of tanks shown in the Boat details settings menu does not match the number of tanks listed when Configure tanks is selected then either:

- The number of tanks selected during the MFD's initial start up wizard may have been incorrect.
- The tank may not have a compatible sender or sender adaptor.
- There is a problem with the data connection or the tank's sender / sender adaptor.

7.7 Calibrating tanks

When displaying tank levels on your MFD it's important to ensure the levels are correctly calibrated. Failure to do so may result in inaccurate level readings.

Tanks can be calibrated and edited on the Boat details settings menu: *[Homescreen > Settings > Boat details]*.

Tanks can be calibrated with the following Oceanic Systems tank senders:

- 3271 Volumetric Fuel Sender
- 3281 Water Level Senders
- 3125 Tank Sender Adapter
- 4291 Tank Level Adapter

Note:

- Ensure tanks are empty before calibration.
- Completing calibration will overwrite any existing calibration already recorded.

From the *[Boat details]* menu:

1. Select *[Configure tanks]*.
2. Select the tank you want to calibrate.
The Pop-over menu is displayed.

3. If required, adjust the tank's capacity

4. Select *[Calibrate]* and then select either *[Run wizard]*, or *[Import calibration]*.

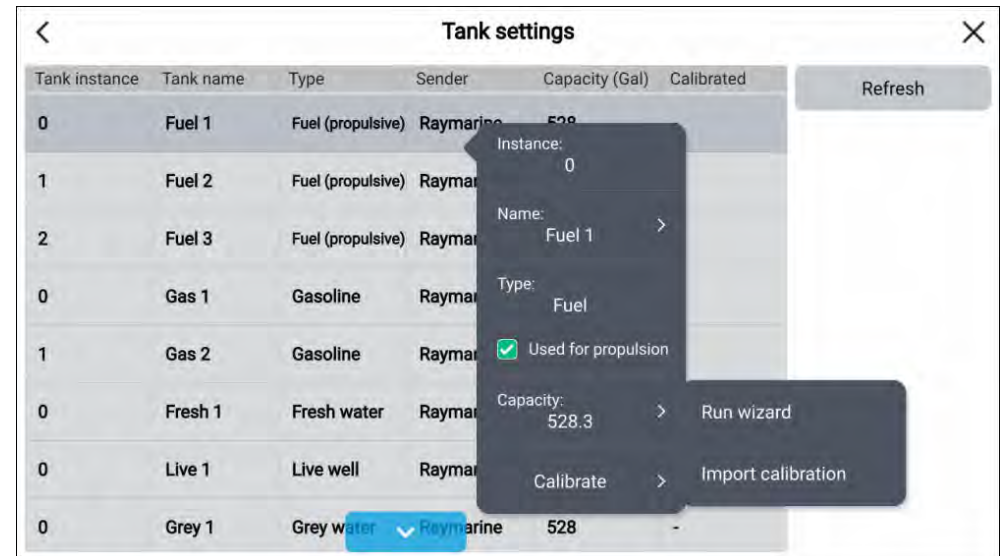

Run wizard calibration

You can calibrate your tank by setting a series of *[calibration points]* and filling your tank in intervals.

The shape of your tank determines how many calibration points you should enter for calibration. 2 calibration points are required as a minimum, but up to 101 points can be entered. Generally, the more calibration points entered the more precise tank readings will be.

Additional calibration points are used to account for changes in tank volume at different parts of an irregularly shaped tank. Depending on the size and shape of your tank it is recommended that you enter calibration points to mark each change in the shape of the fuel tank; for example, straight corners require an additional point, and slopes require 2 points.

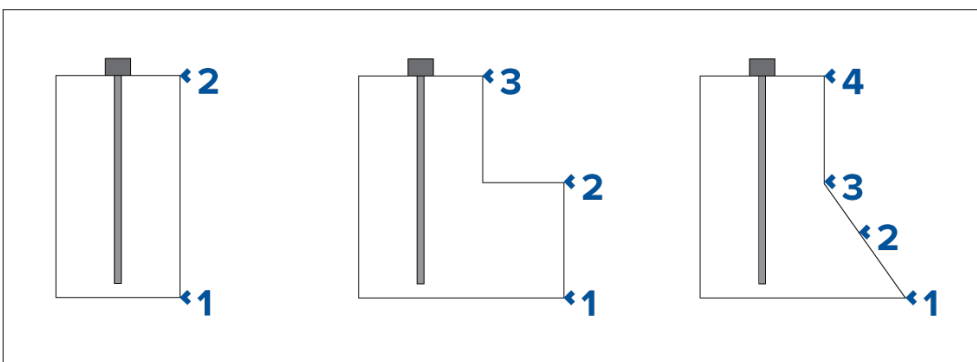

The illustration above shows the minimum number of calibration points recommended for some typical tank shapes:

1. The tank shown on the left is rectangular and symmetrical; it only requires 2 calibration points to define the bottom and top of the tank.
2. The tank shown in the center has a greater volume at the bottom; 3 points are required to define the bottom, top and corner of the fuel tank.
3. The tank shown on the right has a greater volume at the bottom and is sloped. 4 points are required to define the slope of the tank, the top, and a further 2 points to define the slope.

[Wizard Calibration]

1. Select the number of calibration points (minimum of 2) and press [next].
2. Fill the tank to the units displayed on screen and press [Ok].
3. To complete the calibration process, repeat step 2 until the tank has been filled.

Import calibration

You can calibrate your tanks by importing CSV files that contain specific tank calibration data. These files are typically supplied by tank manufacturers or dealers.

Note: CSV files used for import calibration must start with: '0,0' and end in: '100,100'

To [Import calibration] via CSV file:

1. Select the appropriate CSV file from the file explorer.
2. Press [Yes].

Settings

7.8 Setting fuel tanks as not for propulsion

By default all fuel tanks will be used for fuel economy calculations. If required, you can configure specific fuel tanks so that they are not used in fuel economy calculations.

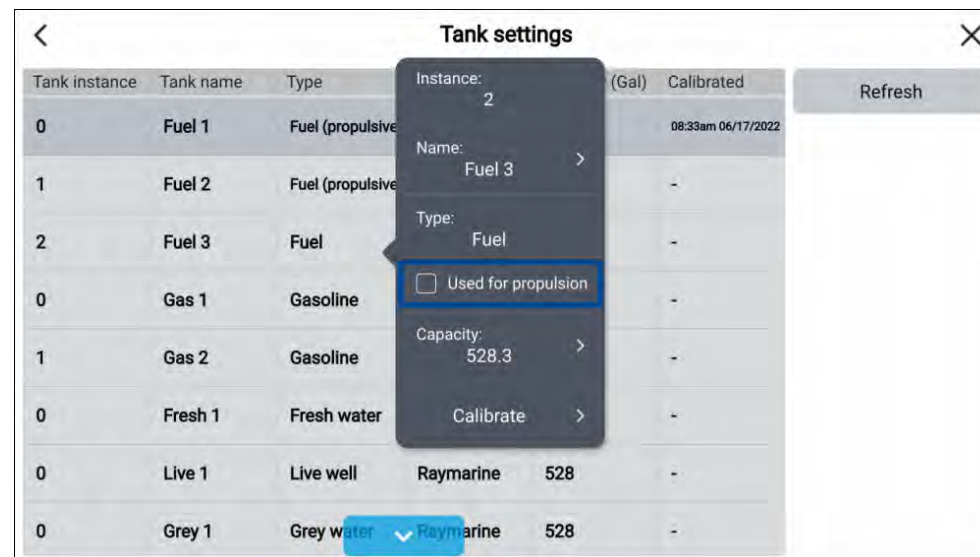

Note:

- Fuel tanks currently being included in fuel economy calculations will be listed as **Fuel (propulsive)**.
- Fuels tanks listed as **Fuel** will not be included in fuel economy calculations.
- Fuel tanks listed as **Gasoline** will never be included in fuel economy calculations.

From the [Boat details] settings menu ([Homescreen > Settings > Boat details]):

1. Select [Configure tanks].
2. Select the relevant fuel tank from the list.
3. Select the [Used for propulsion] tick box so that the tick is removed.

With the tick removed the selected fuel tank will no longer be used for fuel economy calculations.

7.9 Units settings menu

The Units [/]menu is used to specify your preferred units of measure for data readings. The Units menu can be accessed from the Homescreen: [*Homescreen > Settings > Units*] or from the Dashboard app: [*Menu > Settings > Units*].

Units

Measurement	Units
<i>[Distance units]</i>	<ul style="list-style-type: none"> • <i>[NM & ft]</i>— Nautical miles & Feet • <i>[NM & m]</i>— Nautical miles & Meters • <i>[mi & ft]</i>— Miles & Feet • <i>[km & m]</i>— Kilometers and Meters • <i>[NM & yd]</i>— Nautical miles & Yards
<i>[Speed units]</i>	<ul style="list-style-type: none"> • <i>[Kts]</i>— Knots • <i>[MPH]</i>— Mile per hour • <i>[KPH]</i>— Kilometers per hour
<i>[Depth units]</i>	<ul style="list-style-type: none"> • <i>[Meters]</i>— m • <i>[Feet]</i>— ft • <i>[Fathoms]</i>— Fm
<i>[Temperature units]</i>	<ul style="list-style-type: none"> • <i>[Celsius]</i>— C • <i>[Fahrenheit]</i>— F
<i>[Date format]</i>	<ul style="list-style-type: none"> • MM : DD : YYYY • DD : MM : YYYY • MM : DD : YY • DD : MM : YY

Measurement	Units
<i>[Lat/Long format]</i>	<ul style="list-style-type: none"> • DD°MM'.MMM • DD:MM:SS • DD:MM:SS.S • DD:MM.MMM • DD°MM'SS • DD°MM.MMM'
<i>[Volume units]</i>	<ul style="list-style-type: none"> • <i>[US Gallons]</i>— Gsl • <i>[Imperial Gallons]</i>— Gal • <i>[Liters]</i>— Ltr
<i>[Economy units]</i>	<ul style="list-style-type: none"> • Distance per Volume • Volume per Distance • Liters per 100 km
<i>[Wind speed units]</i>	<ul style="list-style-type: none"> • <i>[Knots]</i>— kts • <i>[Meters per Second]</i>— m/s
<i>[Pressure units]</i>	<ul style="list-style-type: none"> • <i>[Bar]</i> • <i>[PSI]</i> • <i>[Kilopascals]</i>— KPa
<i>[Time format]</i>	<ul style="list-style-type: none"> • 12hr • 24hr

Bearing and variation

Menu item/description	Options
<i>[Bearing mode]</i> Determines how bearing and heading data is displayed.	<ul style="list-style-type: none"> • True • Magnetic
<i>[System Datum]</i> Determines the datum used by your display. This should be set to the same datum used by your paper charts.	List of available datums.
<i>[Variation]</i> When set to <i>[Auto]</i> the display will automatically compensate for the naturally-occurring offset of the Earth's magnetic field.	<ul style="list-style-type: none"> • Auto • Manual
<i>[Manual variation]</i> When <i>[Variation]</i> is set to <i>[Manual]</i> , you can specify an offset.	30° W to 30° E

Time differentials

Time differentials are used for Loran positioning.

Measurement	Units
<i>[Chain]</i>	List of available Loran 'master' chains.
<i>[Slave 1]</i> Cannot be set to the same as Slave 2	Filtered list of slave stations based on selected chain..
<i>[Slave 2]</i> Cannot be set to the same as Slave 1	Filtered list of slave stations based on selected chain..
<i>[ASF 1]</i> Additional Secondary Factors	-9.9 to +9.9
<i>[ASF 2]</i> Additional Secondary Factors	-9.9 to +9.9

7.10 Splashscreen and background images

During boot up the display will show the splashscreen logo. Once booted the Homescreen will use a preset background image, based on the Boating activity chosen during the start up wizard. You can configure your display to use custom images for the splashscreen and the Homescreen background.

Your custom images must meet the following requirements:

Note:

- Custom images must be in .png, .bmp or .jpg format.
- You cannot use copyrighted images without permission from the copyright owner.
- Custom images cannot exceed the maximum resolution supported by your display.
- For optimum image quality, the resolution of the image should match the resolution of your display.

Your display's resolution can be found in the Splashscreen and Homescreen background image settings: *[Homescreen > Settings > This display]*. Refer to the following table for a full list of screen resolutions: [Screen resolutions](#).

Custom images are unique to each display and are not shared across the network. You can reset the Splashscreen and Homescreen images to use default images.

Performing a factory reset will also remove any custom images.

Screen resolutions

The screen resolutions for Axiom and Axiom 2 displays are shown below.

MFD variant	(W x H)	DPI
Axiom+ 7	1024 x 600	170.77 (Pixels not square)
Axiom+ 9	1280 x 720	163.45
Axiom+ 12	1280 x 800	124.5
Axiom 7	800 x 480	134.31 (Pixels not square)

MFD variant	(W x H)	DPI
Axiom 9	800 x 480	104.24 (Pixels not square)
Axiom 12	1280 x 800	124.5
Axiom Pro 9 / Axiom 2 Pro 9	1280 x 720	163.45
Axiom Pro 12 / Axiom 2 Pro 12	1280 x 800	124.5
Axiom Pro 16 / Axiom 2 Pro 16	1920 x 1080	141.7
Axiom XL 16 / Axiom 2 XL 16	1920 x 1080	141.7
Axiom XL 19 / Axiom 2 XL 19	1920 x 1080	119.25
Axiom XL 22 / Axiom 2 XL 22	1920 x 1080	102.44
Axiom XL 24 / Axiom 2 XL 24	1920 x 1200	94.07

Customizing the splashscreen

The standard Axiom® logo splashscreen that is displayed during boot up can be customized.

Note:

Images that are not the correct resolution are automatically stretched to fill the screen.

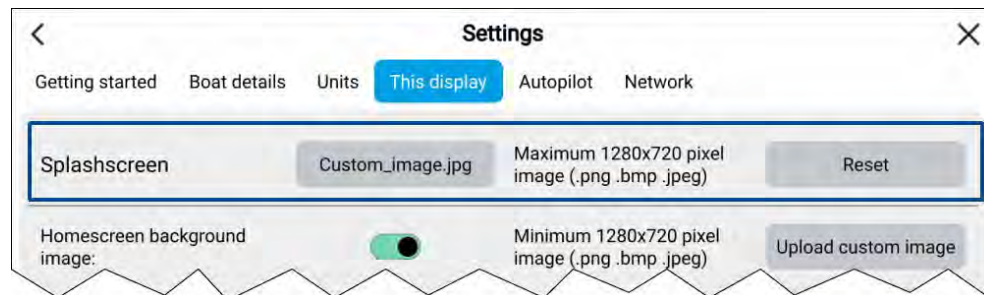

1. Save your custom image to a MicroSD card and insert the card into a card reader slot on your display.
2. Select *[This display]* from the *[Settings]* menu: *[Homescreen > Settings > This display]*.

3. Select the *[Splashscreen]* field containing the image name (default image is Axiom.jpg or Axiom.png).
The file browser is displayed.
4. Browse to your custom image and select it.
5. Select *[Yes]* on the notification popup.
The image is imported to your display.

The next time your display switches on, your custom image will be displayed. You can reset the image at anytime by selecting *[Reset]*.

Customizing the homescreen background

The homescreen background can be configured to display a custom image.

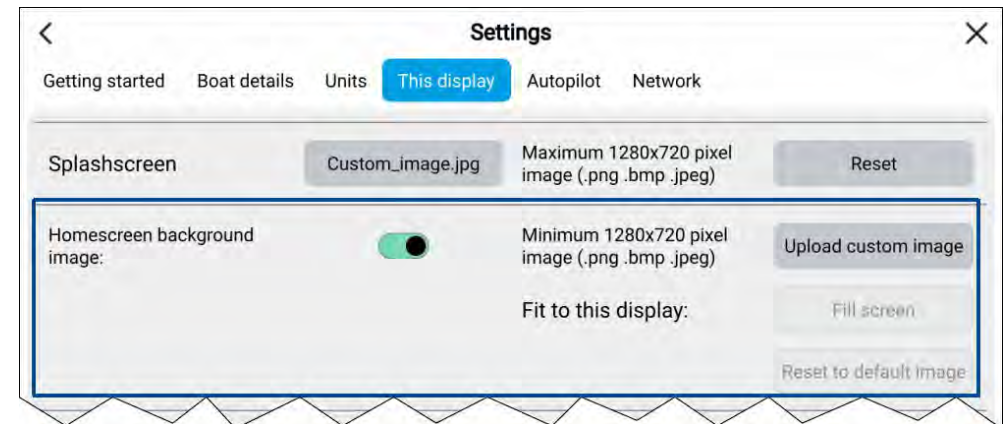

1. Save your custom image to a MicroSD card and insert the card into a card reader slot on your MFD.
2. Select *[This display]* from the *[Settings]* menu: *[Homescreen > Settings > This display]*.
3. Ensure *[Homescreen background image]* toggle switch is enabled.
4. Select *[Upload custom image]*.
The file browser is displayed.
5. Browse to your custom image and select it.
6. Select *[Use as background]* from the pop-over menu.
The Homescreen will be displayed using your custom image as the background

If the image is not the same resolution as your MFD then you can stretch the image by selecting *[Fill screen]* from the *[Fit to this display]* menu option: *[Homescreen > Settings > This display > Fit to this display]*. By default this setting will be set to *[Fill screen]*.

You can reset the image at anytime by selecting *[Reset to default image]*.

7.11 Shared Brightness

Shared brightness enables simultaneous brightness adjustment of all products that are part of the same group.

The following products are compatible with shared brightness:

- Alpha Performance Displays
- LightHouse 4 MFDs.
- LightHouse 3 MFDs using software v3.4.102 or later.
- SeaTalk NG Instrument displays and Pilot controllers.
- SeaTalk NG VHF DSC Radios.
- RMK-9 and RMK-10 remote keypads.

Any adjustments to the shared brightness level will be applied to all products assigned to the same group.

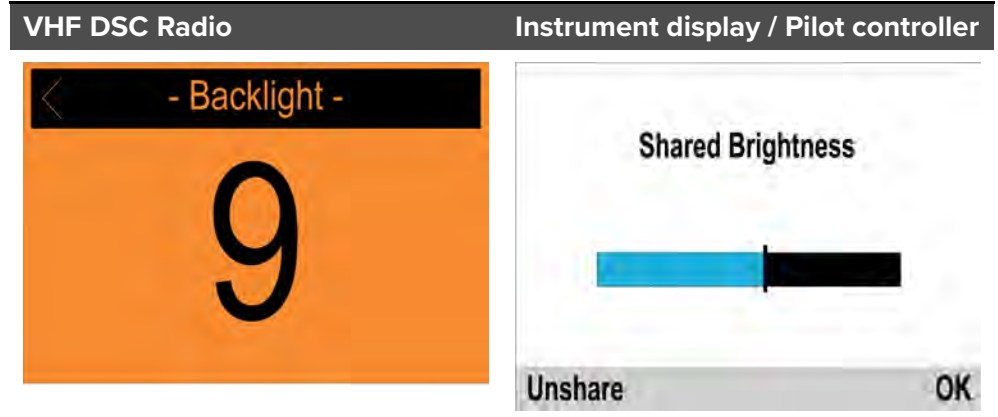
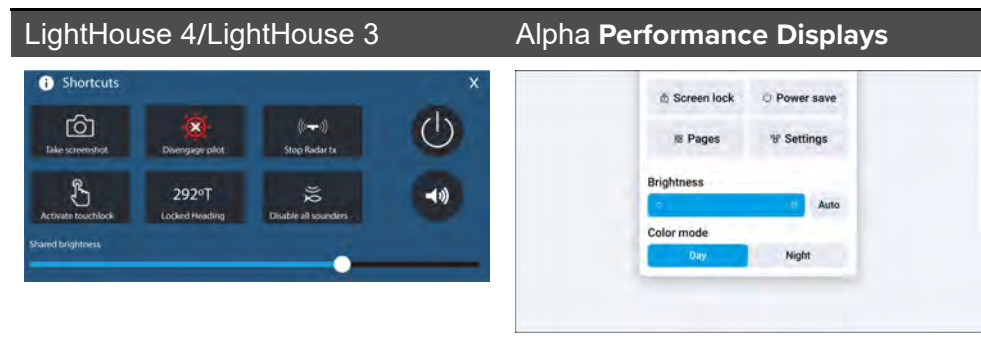

Multiple brightness groups can be configured. For example, these groups could be used to reflect the physical location of products on your vessel e.g.: helm and flybridge.

Shared brightness requires:

- All products to be compatible with the shared brightness function (see list of compatible products above).
- The *[Shared brightness]* setting set to *On* for all products in the brightness group.
- Products to be assigned to network groups.
- All the products in each group to be synchronized.

Note:

If any display in the system has automatic brightness enabled then all displays in the group will automatically adjusted their brightness.

Setting up shared brightness

To set up shared brightness follow the steps below.

Before setting up shared brightness on your MFD, ensure that all displays that you want to use shared brightness are switched on and set to the same *[Display group]* as your MFD.

1. Select *[This display]* from the *[Settings]* menu: *[Homescreen > Settings > This display]*.
2. Select *[Display group]*.
A list of available display groups is displayed.

3. Select the display group that you want the MFD to be part of (Displays that have been installed next to each other should be in the same group).
4. Enable *[Shared brightness]* using the toggle switch.
5. Select *[Sync]*.

'Shared brightness active' is displayed when complete.

Note:

Display group selection may impact Mercury SmartCraft integration. Refer to: [p.417 – Mercury SmartCraft helm grouping](#)

7.12 Datamaster

Systems containing more than one display must have a designated datamaster display. The datamaster is the primary display in the network, and should be the display that is physically connected to the SeaTalkng® / NMEA 2000 CAN bus network, and any other devices and sources of data in your system. The datamaster bridges the data over the ethernet network to any compatible 'repeater' displays.

Information shared by the datamaster includes:

- Cartography
- Waypoints, Routes and Tracks
- Radar
- Sonar
- Data received from the autopilot, GNSS (GPS) receiver, instruments, transducers, the engine and any other compatible external sources.

Note:

Your system may be wired for redundancy with data connections made to repeat displays. However these connections will only become active in the event of a fault and / or reassignment of the datamaster.

Note:

In an autopilot system which does not contain a dedicated pilot control head the datamaster also acts as the autopilot controller.

Switching datamaster

You can switch the MFD you want to be the datamaster at any time.

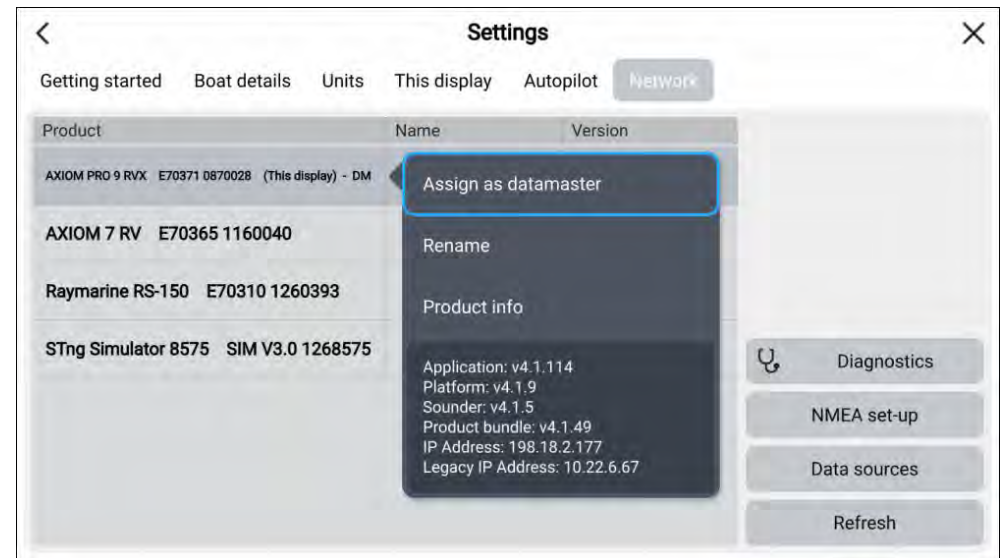

From the *[Network]* tab (*[Homescreen > Settings > Network]*):

1. Select the desired MFD from the list.
2. Select *[Assign as datamaster]* from the pop-over options.

7.13 Switching off sensor LEDs

To assist users who wish their vessel to “go dark” (i.e. not emit any visible light), the LED indicators present on SeaTalk NG position sensors can be switched off. Supported devices: RS150, EV-1, EV-2 and AR200).

Note:

The *[Always Off]* feature may not be available for devices running older software versions. Ensure that you obtain the latest available software for your position sensors.

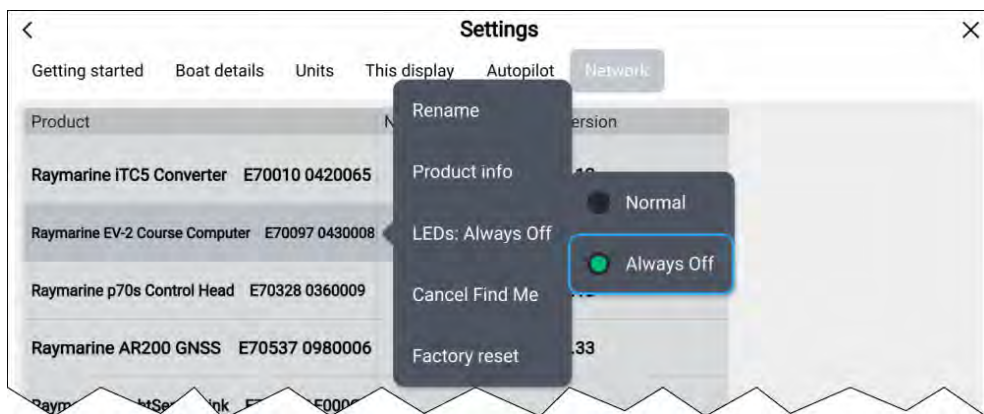

1. Open the *[Network]* settings menu: *[Homescreen > Settings > Network]*.
2. Select the relevant sensor from the network list.
3. Select *[LEDs:]*.
4. Select *[Always Off]*.

The status LED on the selected device will now be switched off, and will remain off until this setting is reverted to *[Normal]*, or the *[Find Me]* feature is enabled.

7.14 Find me

The *[Find me]* feature assists you in finding the physical installation location of a specific Raymarine SeaTalk NG position sensor (i.e.: RS150, EV-1, EV-2, or AR200).

The *[Find me]* feature works by making the selected device's status LED flash continuously for 5 minutes, giving you time to search the vessel to determine the device's physical location. The feature works even if the device's LEDs have been switched to *[Always off]*.

The *[Find Me]* flash sequence will be visibly different than normal LED status sequences in that both the red and green LEDs will flash on and off at the same time, twice every second for 5 minutes.

Note:

The *[Find me]* feature may not be available on devices running older software versions. Ensure that you obtain the latest available software for your position sensors.



To initiate the *[Find Me]* feature for a specific SeaTalk NG device, locate the device name in the *[Network]* settings menu, and then select *[Find Me]* from the device's pop-over menu.

Once *[Find Me]* has been activated, its menu option will change to *[Cancel Find Me]* until 5 minutes has elapsed.

Selecting *[Cancel Find Me]* at any time within the 5 minute timeframe will stop the LED flashing and return the device to its previous LED state.

7.15 IP device user interface access

The user interface of connected, supported IP (Internet Protocol) devices (such as IP cameras) can be accessed from the MFD.

The IP device's user interface is accessed from the Network settings menu: *[Homescreen > Settings > Network]*.

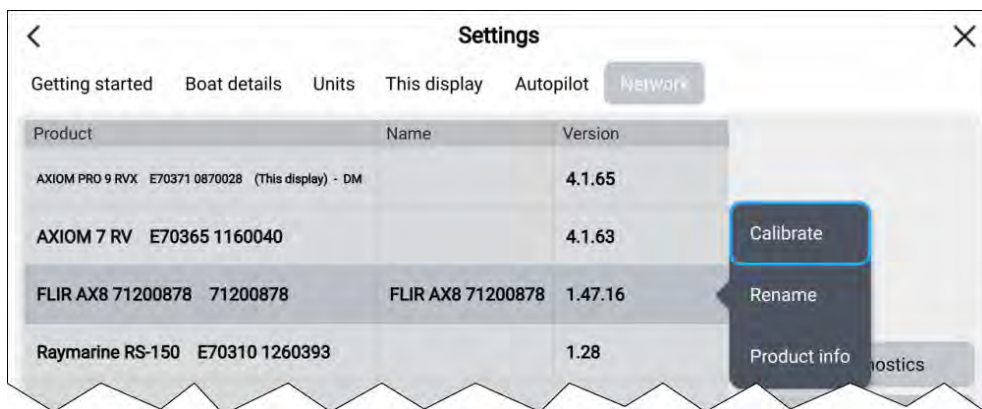

Select the device from the list to display the pop-over menu, and then select *[Calibrate]*.

7.16 Connecting to a wireless display

Axiom® and Axiom® 2 display screens can be mirrored to an external display that has built-in wireless mirroring feature or using an external dongle

1. Follow the instructions provided with your external display or dongle to set up that specific device.
2. On your Axiom® or Axiom® 2 display, select the display icon found under *[Wireless display:]* on the *[This Display]* tab of the *[Settings]* menu: (*[Homescreen > This Display > Wireless Display:]*).

Your Axiom® or Axiom® 2 display will search for available external displays.



3. Select the external display you want to use.

4. If your Axiom® or Axiom® 2 display has Wi-Fi Sharing enabled then a PIN number is displayed on the external display, input this pin number when requested by your Axiom® or Axiom® 2 display.
5. You may also be requested to allow the external display to connect automatically in future, select *[Yes]* or *[No]* as appropriate on your external display.
Your Axiom® or Axiom® 2 display screen will now be displayed on the external display.
6. To allow the external display to connect each time your Axiom® or Axiom® 2 display is switched on, enable *[Connect on power up]* from the pop-over options.



Note:

1. Don't forget to check your external display for any required confirmations / acknowledgements during the connection process.
2. Some non Miracast-certified devices may not be able to connect with Wi-Fi Sharing enabled, in this case disable Wi-Fi Sharing and try again.
3. If you experience connection issues, try disabling and enabling the wireless display feature on the external display and on your Axiom® or Axiom® 2 display, or power cycle both devices.
4. Once connected/paired to an external display do not change your Axiom® or Axiom® 2 display's Wi-Fi Passphrase, as on certain devices a factory reset maybe required to re-establish a connection.

Disconnecting a wireless display

With a wireless display connection active:

1. Select Disconnect from the *[This Display]* tab: (*[Homescreen > Settings > This Display > Wireless Display: > Disconnect]*).

Unpairing a wireless display

With the wireless display connection active:

1. Select the connected display from the Wireless display menu: (*[Homescreen > Settings > This Display > Wireless Display:]*).
2. Select the connected display from the list of available displays.
3. Select *[Unpair]* from the pop-over menu.

7.17 NMEA 0183 settings

NMEA 0183 devices can be connected directly to Axiom® Pro and Axiom® XL displays using the NMEA 0183 wires on the Power/Video/NMEA 0183 cable.

Note:

NMEA 0183 settings are not available on Axiom® 2 displays.

2 NMEA 0183 ports are available:

- **Port 1:** Input and output, 4,800 or 38,400 baud rate.
- **Port 2:** Input only, 4,800 or 38,400 baud rate.

The baud rate for each input port must be specified in the *[NMEA set-up]* menu (*[Homescreen > Settings > Network > NMEA set-up]*).

Note:

- For Port 1, both the input and output communicate at the same baud rate. For example, if you have one NMEA 0183 device connected to Port 1 INPUT, and another NMEA 0183 device connected to Port 1 OUTPUT, both NMEA devices must use the same baud rate.

NMEA 0183 settings

The following options are available from the *[NMEA Set-up]* menu.

Menu item	Description	Options
<i>[NMEA Port 1]</i>	Baud rate selection.	<ul style="list-style-type: none"> • 4,800 • 38,400
<i>[NMEA input port 2]</i>	Baud rate selection.	<ul style="list-style-type: none"> • 4,800 • 38,400
<i>[Bridge heading]</i>	Bridge heading data from NMEA 0183 to NMEA 2000 / SeaTalkng®	<ul style="list-style-type: none"> • Yes • No
<i>[Transmission mode]</i>	<p>Switches between Single-ended and Differential transmission modes.</p> <p>The Differential transmission mode supports higher speeds, longer cable runs, and better data integrity. Differential mode works when connected to opto-isolated inputs, as specified by the NMEA 0183 standard.</p> <p>The Single-ended mode is required when sending a signal to a single-ended receiver device, such as a PC for example.</p> <p>Refer to the <i>NMEA 0400 Installation Standard</i> for wiring guidelines for the different transmission modes.</p>	<ul style="list-style-type: none"> • Single-ended • Differential
		<p>Note: Only available on Axiom™ Pro and Axiom™ XL displays.</p>
<i>[Individual outputs]</i>	List of NMEA 0183 sentences for which the output can be disabled.	<ul style="list-style-type: none"> • Enabled • Disabled

CHAPTER 8: ALARMS MANAGER

CHAPTER CONTENTS

- 8.1 Alarms manager — page 127
- 8.2 Active alarm indication — page 128
- 8.3 Alarm settings — page 128
- 8.4 External alarm speaker / buzzer — page 130
- 8.5 Acknowledging alarms — page 130
- 8.6 YachtSense Link router alarms — page 130
- 8.7 Digital switching alarms — page 131
- 8.8 Man Overboard (MOB) — page 131
- 8.9 DSC distress notification — page 132
- 8.10 High Speed Alarm — page 132

8.1 Alarms manager

The alarms manager is used to configure available alarm's settings, view details of currently active alarms and provides an alarms history.

Active alarms

The alarms manager can be accessed by selecting the *[Alarms]* icon on the Homescreen.

Example: Active alarms list

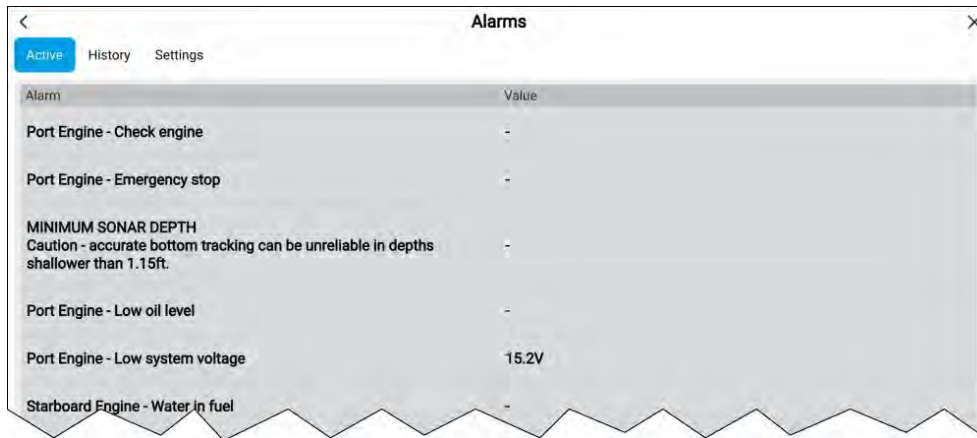

The Active alarms tab lists all alarms that are currently active. Alarms will remain active until the conditions that triggered the alarm is no longer present, e.g.: a Shallow depth alarm will automatically dismiss when the depth becomes deeper.

Alarm history

Example: Alarm history tab

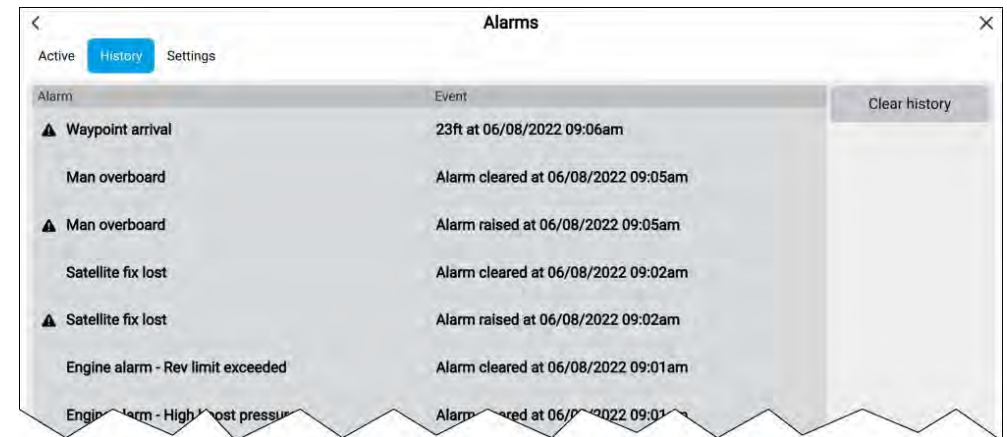

All Dangerous (Red) and Warning (Orange) alarms will appear in the alarms history list. The history list will include an entry for the alarm being triggered (raised) and also for when the alarm is acknowledged (cleared). The alarm field contains the name of the alarm and the events field contains details of the alarm condition and its time and date.

Alarm events will remain in the alarms history list until cleared. The list is cleared by selecting *[Clear history]*.

Alarms settings

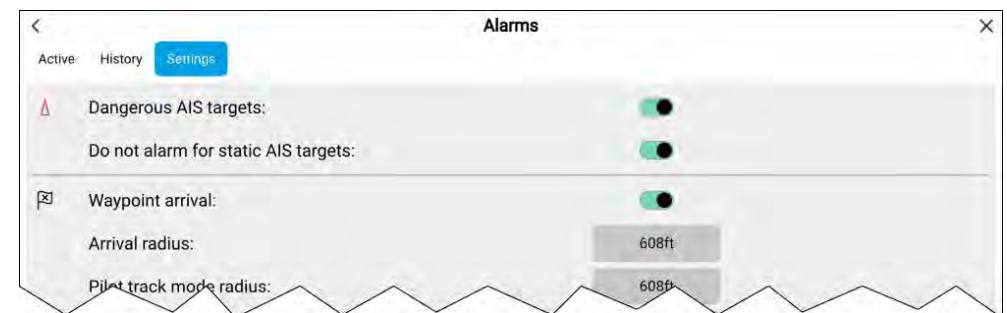

Alarms settings can be configured from the alarms settings tab.

8.2 Active alarm indication

When alarms are active the homescreen *[Alarms]* icon will identify the number of active alarms in the top right corner. The *[Home]* icon in app pages can also be configured to provide an active alarm indicator.

The app pages home icon indicator can be enabled and disabled from the alarms manager: *[Homescreen > Alarms > Settings > Home button active alarm indicator]*.

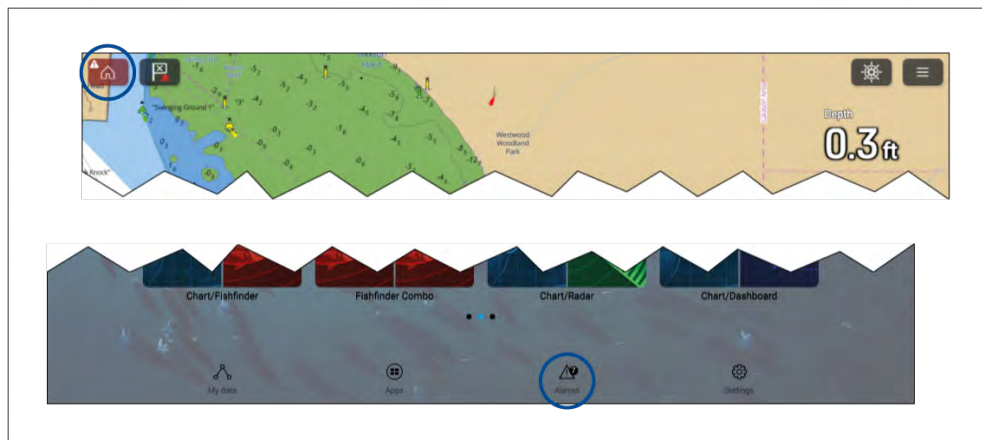

When enabled the *[Home]* icon will turn red and have an exclamation mark placed inside it.

The homescreen *[Alarms]* icon will identify the number of active alarms.

8.3 Alarm settings

The alarms listed below can be enabled and disabled and where applicable alarm threshold values can be adjusted. Certain alarms may require specific connected peripheral devices or configurations.

Note:

Hardware dependent alarms are only triggered when relevant hardware (e.g.: sensors) is connected and reporting the data required for the alarm.

- *[Dangerous Radar targets]*— If enabled; an alarm is triggered when Radar targets become dangerous. Radar targets are deemed dangerous when

they have the potential to cross your path within a specified distance and time. For alarm parameters refer to: [p.349 — Dangerous targets alarm](#)

- *[Lost Radar targets]*— If enabled, an alarm is triggered when dangerous Radar targets become lost (i.e.: no Radar return from the target has been received for 20 seconds).
- *[Dangerous AIS targets]*— If enabled, an alarm is triggered when AIS targets become dangerous. AIS targets are deemed dangerous when they have the potential to cross your path within a specified distance and time. For alarm parameters refer to: [p.231 — Dangerous targets alarm](#)
- *[Do not alarm for static AIS targets]*— Enables ability to ignore AIS targets that are considered static (travelling under 2 Knots). Static targets that become dangerous will still be identified onscreen but will not trigger the dangerous targets alarm.
- *[Guard zone 1]*— If enabled, an alarm is triggered when Radar returns are detected within guard zone 1.
- *[Guard zone 2]*— If enabled, an alarm is triggered when Radar returns are detected within guard zone 2.
- *[Waypoint arrival]*— If enabled, when you arrive at a waypoint, an alarm is triggered. This setting allows you to specify a radius size for three types of arrival alarm. When your vessel crosses the specified radius, the Waypoint Arrival alarm is triggered. The following Waypoint arrival alarms are available:
 - *[Arrival radius]*— Used when the MFD is NOT in pilot integration mode and the Autopilot is in Track mode.
 - *[Pilot track mode radius]*— Used when the MFD is integrated with an Autopilot and the Autopilot is in Track mode.
 - *[Search route arrival radius]*— Used when the MFD is following a SAR pattern. Also helpful when race sailing and using Laylines, or when fishing, as this alarm setting provides a smaller radius to ensure you don't get alerted too far away from the target waypoint.
- *[Interception arrival]*— If enabled, during target interception an alarm is triggered when your vessel reaches the distance specified in *[Arrival radius]*.
- *[Off track]*— If enabled, during active navigation an alarm is triggered when your vessel steers off track by more than the specified *[Cross track error]* value.
- *[Sail recommendation]*— MFD's configured using the Sailing activity will have the *[Sail recommendation]* alarm available. If enabled, when wind

conditions change a sail recommendation notifications will be triggered. Sail recommendations are based on user imported values.

- *[Shallow depth]*— If enabled, when the depth detected by your depth transducer passes the specified value the Shallow depth alarm is triggered.

Note: The MFD shallow depth alarm is independent of the Shallow depth alarm available on instrument displays. If you have Instrument displays connected to your system it is recommended that their shallow depth alarms are disabled.

- *[Position drift]*— If enabled, an Alarm is triggered when your vessel drifts from its current GNSS (GPS) position by more than the specified *[Drift range]*.
- *[Anchor drag]*— When the Anchor drag alarm has been configured and activated in the Chart app the Anchor drag alarms can be turned off by selecting *[Raise anchor]*
- *[Low fuel remaining]*— If enabled, an alarm is triggered when the fuel remaining in your fuel tanks reaches the specified *[Fuel level]*.

Note: The Fuel manager must be enabled for alarms to be triggered.

- *[LightHouse chart obstructions]*, If enabled, an alarm is triggered when an obstruction is detected. For details refer to: [p.236 — Obstruction alarm \(legacy LightHouse charts\)](#)
- *[DSC alarms]*— If enabled, an alarm is triggered when DSC distress calls are received.
- *[AIS safety messages]*— If enabled, an alarm is triggered when AIS safety messages are received.
- *[MOB data type]*— Determines whether the MOB waypoint is fixed at the *[Position]* the alarm was triggered, or advances its position based on tide and wind effects (*[Dead reckoning]*).
- *[Fishing range]*— If enabled, an alarm is triggered when your Depth reading reaches the depth specified in *[Shallow water arrival]* or *[Deep water arrival]*.
- *[Water temperature alarm]*— If enabled, an alarm is triggered when the water temperature reading reaches the temperature specified in *[Lower temp limit]* or *[Upper temp limit]*.

- *[Digital switching alarms]*— When your system includes digital switching a list of all configured digital switching alarms will be displayed. If your system includes a YachtSense™ Link router then the router's alarms will be displayed.

– For details of digital switching alarms refer to:

[p.131 — Digital switching alarms](#)

– For details of YachtSense™ Link router alarms refer to:

[p.130 — YachtSense Link router alarms](#)

- *[AX8 camera messages]*— If enabled, messages from a connected AX8 camera will be presented as alarms on your MFD.
- *[Engine alarms]*— If enabled, alarms will be triggered when engine warning alarms are received from connected, compatible engine management systems or interfaces.
- *[Generator alarms]*— If enabled, Alarms raised by compatible generators will be displayed on the MFD.
- *[Apps and connected devices]*— Select *[Configure]*— Select to enable and disable alerts received from partner integration hardware or apps. For details on partner integrations refer to: [p.498 — Partner Integration and third-party apps](#)
- *[Battery alarms]*— Select *[Configure]* to view the battery configuration page where you can set alarms for each detected battery. For details refer to: [p.114 — Battery configuration](#)
- *[Minimum sonar depth]*— When your sonar transducer detects depths of 0.8 m/2.62 ft the alarm is triggered.

Important: Accurate bottom tracking can be unreliable in depths shallower than 0.8 m/2.62 ft. When operating at or below this depth be cautious of misleading sonar returns or false bottom tracking.

- *[Home button active alarm indicator]*— If enabled, when an alarm is active the onscreen home icon is colored red and contains a warning triangle.
- *[High/maximum AIS targets]*— When the MFD is configured as First responder the High/maximum AIS targets alarm is available. The alarm is triggered when the MFD is reaching or met its maximum limit of 100 AIS targets being displayed onscreen. For details refer to: [p.376 — AIS High target alarm](#)

- *[High speed alarm]* — If, enabled an alarm is triggered when vessel SOG goes above a specified threshold. For details refer to: [p.132 — High Speed Alarm](#)

8.4 External alarm speaker / buzzer

If your MFD has a built-in buzzer or is connected to a wired external buzzer, MFD alarms will trigger an audible tone. If you connect your MFD to a Bluetooth speaker then the alarm tone can also be heard from the speaker.

When connected to a Bluetooth speaker, a separate volume control is available to control the volume of MFD Alarms sounded through the speaker. For more information, refer to: [p.83 — Bluetooth speaker pairing](#)

8.5 Acknowledging alarms

Follow the steps below to acknowledge an active alarm.

With an alarms notification displayed onscreen:

1. Select *[OK]*.
The notification is dismissed and the audible tone is stopped.

An acknowledged alarm remains active until the conditions that triggered the alarm are no longer present.

Note:

If an alarm notification includes an *[Edit]* button, selecting it will display the relevant setting in the Alarms menu so that, if required, you can change the alarm threshold.

8.6 YachtSense Link router alarms

If your system includes a YachtSense™ Link router then you can enable and disable the router's alarms (alert notifications) from the alarms manager.

The following alarms are available:

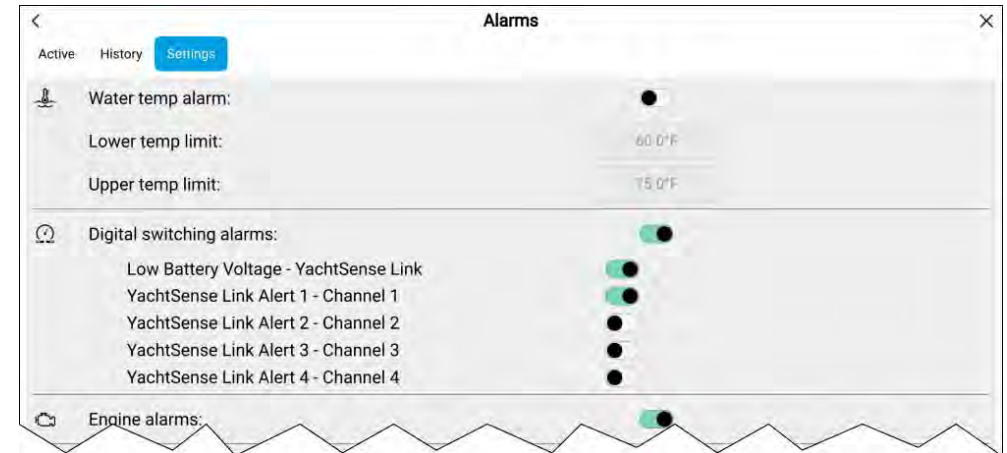

- *[Low Battery Voltage – YachtSense Link]*— An alarm will be triggered when the supply voltage to the router drops below a specified level.
- *[YachtSense Link alert 1 – Channel 1]*— An alarm will be triggered when the router's input channel 1 is above or below a specified value.
- *[YachtSense Link alert 2 – Channel 2]*— An alarm will be triggered when the router's input channel 2 is above or below a specified value.
- *[YachtSense Link alert 3 – Channel 3]*— An alarm will be triggered when the router's input channel 3 is above or below a specified value.
- *[YachtSense Link alert 4 – Channel 4]*— An alarm will be triggered when the router's input channel 4 is above or below a specified value.

The YachtSense™ Link alarms values are configured from the router's Alert notifications web interface page which can be accessed by selecting YachtSense Link from the Homescreen status area and then selecting *[ADVANCED SETTINGS > Alert notifications]*.

8.7 Digital switching alarms

When your MFD is connected and configured with a supported digital switching system, digital switching specific alarms can be enabled and disabled using the alarms manager.

Example: Digital switching alarms

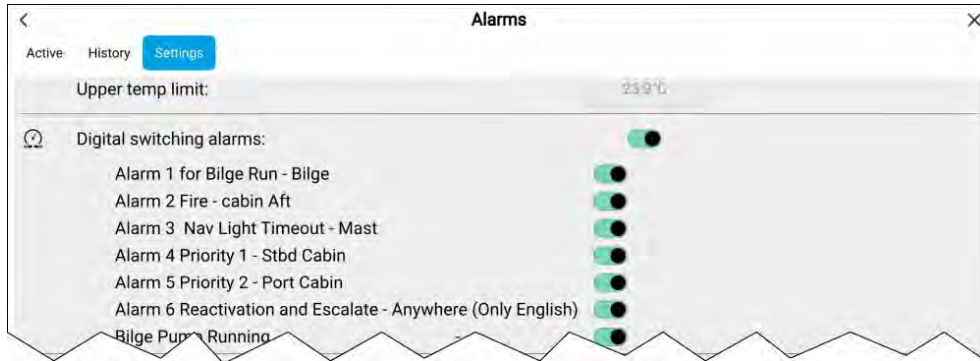

Each digital switching system will be unique as alarms are defined when the system is configured.

8.8 Man Overboard (MOB)

If a person or object falls overboard, you can use the Man Overboard (MOB) alarm to mark the position that your vessel was at when the MOB alarm was activated.

The MOB alarm is activated using the MOB icons.

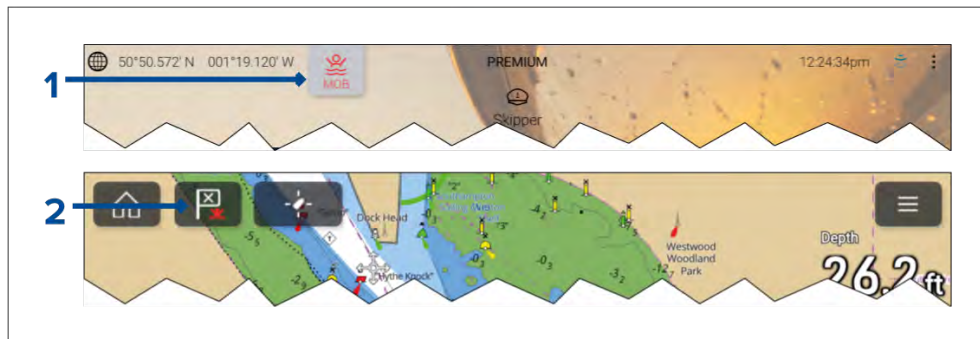

1. The MOB alarm can be activated by pressing and holding on the MOB icon on the Homescreen.
2. The MOB alarm can also be activated by pressing and holding on the waypoint / MOB icon located at the top of all MFD apps.

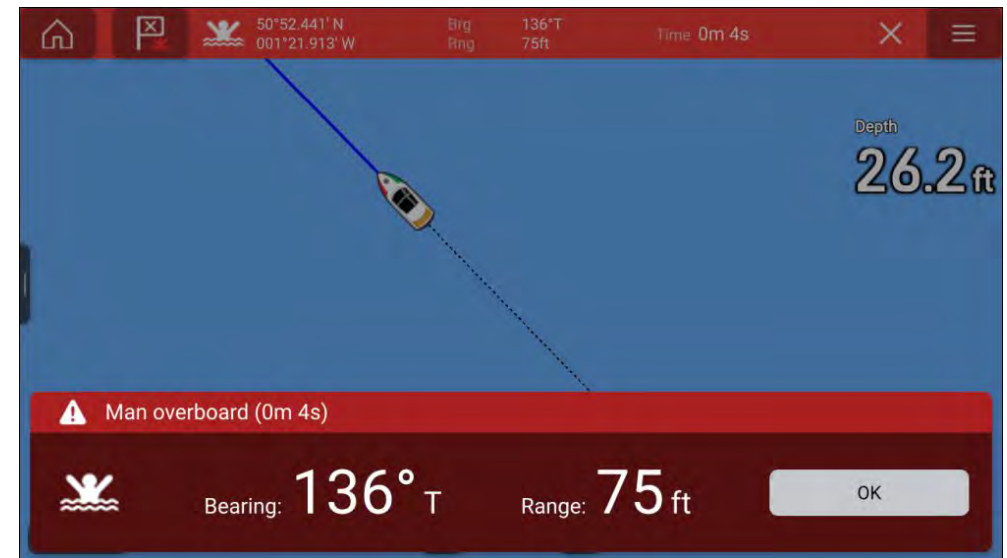

The MOB feature requires your vessel to have a valid position fix from a GNSS (GPS) receiver. Dead reckoning mode also requires Heading and Speed data.

When you activate the MOB alarm:

- an audible alarm is sounded which is repeated every 30 seconds until the alarm is cancelled.
- a MOB Databar providing Bearing and range to the MOB, and elapsed time since MOB was initiated, is displayed along the top of the screen. The Databar persists across apps and the Homescreen, and remains until the MOB alarm is cancelled.
- a MOB warning is displayed in the bottom of the screen, which requires acknowledgement.
- the Chart app is placed in a special MOB mode to help you navigate back to the point your vessel was at when the MOB was initiated.

MOB mode

MOB can be set to *Dead Reckoning* or *Position* mode. Dead Reckoning mode will take into consideration the effects of wind and tides. This usually provides a more accurate course. Position mode does not take these factors into account. You can change the MOB mode at anytime from the Alarms menu: [*Homescreen* > *Alarms* > *Settings* > *MOB data type*:].

8.9 DSC distress notification

The MFD can display DSC distress alert information received by a connected DSC VHF radio.

When DSC alarms are enabled ([*Homescreen* > *Alarms* > *Settings* > *DSC alarms*]), a notification is displayed on the MFD when a DSC distress call is received by your DSC VHF radio.

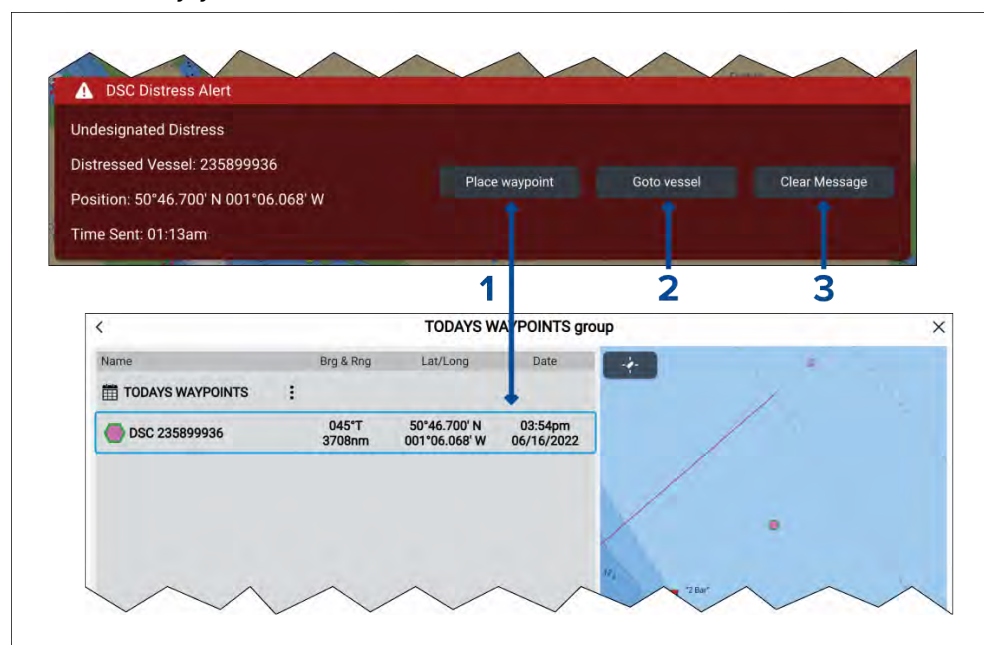

1. [*Place waypoint*]— Selecting [*Place waypoint*] places a waypoint at the latitude and longitude specified in the notification. The special DSC waypoint symbol is used for waypoints created from DSC notifications. DSC waypoints use the MMSI of the originating vessel as the waypoint name. If subsequent DSC distress calls are received from the same

vessel MMSI then, after selecting [*Place waypoint*], there will be 2 options to choose from:

- [*Replace waypoint*]— Selecting this option replaces the existing waypoint with a new waypoint using the updated notification details.
 - [*Place new waypoint*]— Selecting this option creates a new waypoint and adds a suffix (A.B.C etc.) to each new waypoint's name.
2. [*Goto waypoint*]— Selecting this option sets a *Goto* to the latitude and longitude specified in the notification.
 3. [*Clear message*]— Selecting this option clears the alert from the screen.

Note:

If position data is not included in the DSC notification, [*Place waypoint*] and [*Goto waypoint*] options will not be available.

8.10 High Speed Alarm

A [*High speed alarm*] is available which will trigger a warning alarm when the reported SOG (Speed Over Ground) exceeds the specified threshold. The [*High speed alarm*] uses SOG reported by a connected GNSS (GPS) receiver.

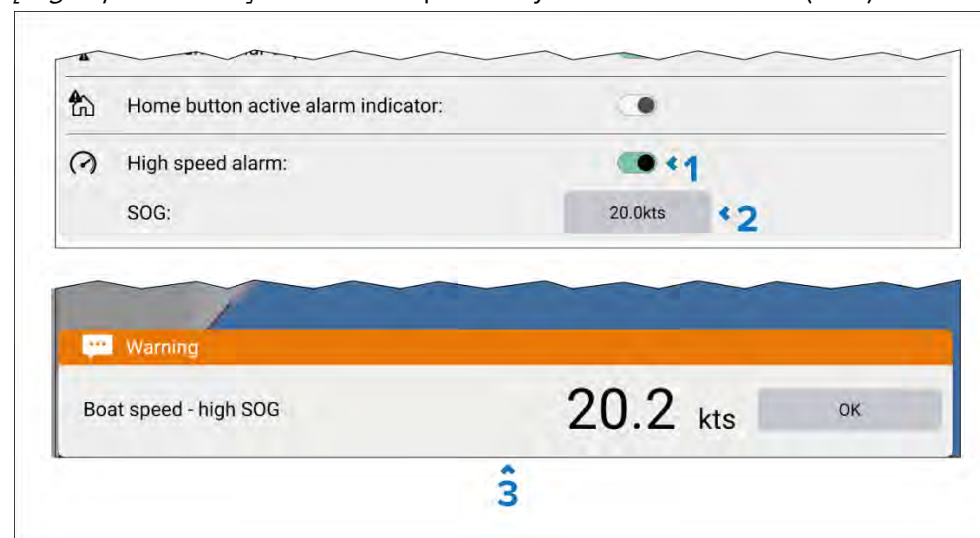

1. Use the [*High speed alarm*] toggle switch located in the [*Alarms*] settings menu to enable or disable the [*High speed alarm*]. The alarm is disabled by default.

2. Set a *[SOG]* threshold. When SOG exceeds this value the *[High speed alarm]* is triggered.
3. *[High speed alarm]* warning notification. The notification and audible beep will persist until acknowledged or until SOG drops below the specified threshold.

CHAPTER 9: AUTOPILOT INTEGRATION

CHAPTER CONTENTS

- 9.1 Commissioning - Evolution autopilot system — page 135
- 9.2 Autopilot control — page 140
- 9.3 Pilot sidebar — page 142
- 9.4 Pilot Version keypad LED status (Axiom® 2 Pro only) — page 143
- 9.5 Pilot pop-up — page 143
- 9.6 Autopilot Control — Pilot set-up menu — page 143
- 9.7 Rudder damping levels and deadband angles — page 146

9.1 Commissioning - Evolution autopilot system

Commissioning pre-requisites

Before commissioning your autopilot system for the first time, ensure that you have read through and understood the entire commissioning instructions for your autopilot system.

Before commissioning, you should also ensure the following:

- All autopilot system components have been installed in accordance with the installation instructions supplied with the system components.
- All autopilot system components have been updated to the latest available software versions, available on the Raymarine website.
- A system schematic is available which includes all system components and required connections.
- The commissioning engineer is familiar with the vessel's hull type, drive type and steering system.

Commissioning steps

The required commissioning steps should be carried out in the correct order using the pilot controller display.

Note:

Commissioning must be performed using the datamaster MFD.

1. Power-up all of the components that make up your autopilot system.
2. Select the relevant vessel hull type for your vessel.
3. Complete the dockside calibration process, using the *[Dockside wizard]*.
4. If the system does NOT include a rudder reference transducer then, specify the hard-over time.
5. Complete compass linearization.
6. If required, lock the compass.

Vessel hull type selection

The vessel hull type options are designed to provide optimum steering performance for typical vessels.

It is important to complete the vessel hull type selection, prior to performing dockside calibration, as it forms a key part of the commissioning process. The vessel hull type options can be accessed at any time, when the autopilot is in Standby from the *[Pilot set-up]* menu: *[Homescreen > Settings > Autopilot > Pilot set-up > Vessel Hull Type]*.

The option that most closely matches your vessel's hull type and steering characteristics should be selected from the available hull types:

- *[Power]*
- *[Power (slow turn)]*
- *[Power (fast turn)]*
- *[Sail]*
- *[Sail (Slow turn)]*
- *[Sail Catamaran]*

Note:

It is important to be aware that steering forces (and therefore rate-of-turn) vary significantly depending on the combination of vessel hull type, steering system, and drive type. The available vessel hull type options are provided for guidance only. You may wish to experiment with the different vessel hull type options, as it might be possible to improve the steering performance of your vessel by selecting a different vessel hull type. When choosing a suitable vessel hull type, the emphasis should be on a safe and dependable steering response.

Using the Dockside wizard

The dockside calibration process must be completed before the autopilot system can be used for the first time. The Dockside wizard guides you through the steps required for dockside calibration.

The Dockside wizard contains different steps depending on whether the system includes rudder reference transducer:

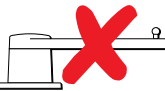
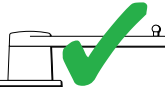
	<p>The following Dockside wizard procedures apply to vessels that do not have a rudder reference transducer:</p> <ol style="list-style-type: none"> 1. Drive Type selection. 2. Rudder Limit setting. 3. Hard-over time setting (Raymarine recommends that this information is specified once the dockside wizard and Rudder Drive check is complete, using the Hard Over Time menu option). 4. Rudder Drive check.
	<p>The following Dockside wizard procedures only apply to vessels that include a rudder reference transducer:</p> <ol style="list-style-type: none"> 1. Drive Type selection 2. Rudder alignment (Align Rudder) 3. Rudder Limit 4. Rudder Drive check.

To access the wizard, ensure the autopilot is in standby and then:

1. Select *[Dockside Wizard]* from the *[Advanced settings]* menu *[Homescreen > Settings > Autopilot > Pilot set-up > Dockside wizard]*.
2. Select *[Continue]* to initiate the dockside wizard and follow the onscreen instructions.

Selecting a drive type

Drive type selection is included in the dockside wizard.

With the *[Drive Type]* menu displayed:

1. Select your drive type.

The drive types available are:

- *Type 1 Linear*
- *Type 2 Linear*
- *Type 2 Hydraulic Linear*
- *Type 3 Hydraulic Linear*
- *I/O Stern*
- *Wheel Drive*

- *Tiller*
- *Sport Drive*
- *Verado*
- *Rotary Drive Type 1*
- *Rotary Drive Type 2*
- *Hydraulic Pump Type 1*
- *Hydraulic Pump Type 2*
- *Hydraulic Pump Type 3*

Important:

If your drive type is not listed, contact your Raymarine dealer for advice.

2. Select *[Continue]*.

Drive type selection is also available when the autopilot is in standby, from the *[Advanced settings]* menu: *[Homescreen > Settings > Autopilot > Pilot set-up > Drive type]*.

Aligning the rudder

For systems that have a rudder reference transducer fitted, Rudder alignment is included in the dockside wizard and comes after drive type selection. For systems without a rudder reference transducer fitted rudder alignment is not required.

	<ul style="list-style-type: none"> • The following procedure only applies to vessels with a rudder reference transducer.
---	---

1. Select *[Continue]*.
2. Center the rudder and select *[OK]*.
3. Put the rudder all the way to port and press *[OK]*.
4. Put the rudder all the way to starboard and press *[OK]*.
5. Center the rudder and select *[OK]*.
6. Select *[Continue]* when the task complete message is displayed to progress to the rudder limit page.

Setting the rudder limit

Rudder limit setting is included in the dockside wizard and comes after rudder alignment or drive selection depending on whether a rudder reference transducer is fitted.

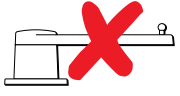
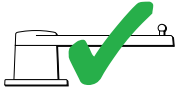
	<ul style="list-style-type: none">• For vessels without a rudder reference transducer• Rudder limit are set to 30 degrees and can be adjusted as required.
	<ul style="list-style-type: none">• For vessels with a rudder reference transducer• The rudder alignment process establishes the rudder limit. The rudder limit will be displayed with a message confirming that the rudder limit has been updated.• If required, the limit can be adjusted.

1. Ensure that the rudder limit is sufficient to prevent the steering mechanism impacting the end stops and placing the steering system under unnecessary load. If required adjust the limit by selecting the rudder limit value box.

Important:

It is recommended that the limit is set to approximately 5 degrees less than the maximum rudder angle.

2. Select *[Continue]* to move to the next step.

Note:

The rudder limit can be adjusted when the autopilot is in standby, from the *[Pilot set-up]* menu: *[Homescreen > Settings > Autopilot > Pilot set-up > Rudder Limit]*.

Hard over time

The hard over time setting can be specified as part of the Dockside wizard and comes after setting the rudder limit.

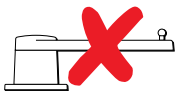
	<ul style="list-style-type: none">• The following information only applies to vessels without a rudder reference transducer.
---	--

- If you already know the hard-over time for your vessel's steering system: enter this time in the Hard over time value box and select Continue.
- If you do NOT know the hard-over time for your vessel's steering system, select *[Continue]*, proceed with the Checking the rudder drive procedure and complete the Dockside wizard. Once the wizard is complete, proceed to the Setting the hard-over time instructions for information on how to calculate and set the hard-over time.

Setting the hard-over time

On vessels without a rudder reference transducer, it is important to set a Hard Over Time.

Before attempting to follow this procedure ensure you have read and understood the Rudder Check warning provided in this document.

To estimate your hard over time follow the steps below:

1. With the autopilot in *[Standby]*, manually turn the rudder / engine full to port. (For vessels with power steering the engine should be running when turning the rudder.)
2. Open the sidebar by swiping right from the left side of the screen.
3. Switch to the Pilot sidebar.
4. Engage *[Auto]* mode.
5. Press the *[+10]* button on the Pilot bar 9 times to ensure that the rudder moves hard over to starboard.
6. Count how many seconds it takes for the rudder to move from hard over port to hard over starboard. This is your hard over time.
7. Enter your hard over time in the. The hard over time setting can be accessed from the *[Pilot set-up]* menu: *[Homescreen > Settings > Autopilot > Pilot set-up > Hard over time]*.
8. After setting the hard over time, observe the autopilot's behavior and if required, make small adjustments to the Hard over time value until a satisfactory result is achieved.



Warning: Rudder check

If no rudder reference has been fitted you MUST ensure that adequate provision is made to prevent the steering mechanism from impacting the end stops.

Checking the rudder drive (rudder reference fitted)

As part of the dockside wizard, the system will check the drive connection. Once it has completed the check successfully, a message will appear asking if it is safe for the system to take the helm.

During this procedure the autopilot will move the rudder. Ensure it is safe to proceed before proceeding.

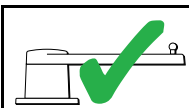

- The following procedure only applies to vessels with a rudder reference transducer.

1. Center and let go of the rudder.
2. Disengage any rudder drive clutch.
3. Select *[Continue]*.
4. Check it is safe to proceed and then select *[OK]*.
The autopilot will now automatically move the rudder.
5. Select *[OK]* when the rudder has moved to port.
6. Select *[OK]* when the rudder has moved to starboard.
7. Select *[Continue]* when the rudder has centered.
8. Dockside calibration is now complete, select *[Continue]*.

Checking the rudder drive (no rudder reference fitted)

As part of the dockside wizard, the system will check the drive connection. Once it has completed the check successfully, a message will appear asking if it is safe for the system to take the helm.

During this procedure the autopilot will move the rudder. Ensure it is safe to proceed before proceeding.

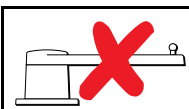

- The following information only applies to vessels without a rudder reference transducer.

1. Center and let go of the rudder.
2. Disengage any rudder drive clutch.
3. Select *[Continue]*.
4. Check it is safe to proceed and then select *[OK]*.
The autopilot will now automatically move the rudder.

5. You will be asked to confirm that the rudder has turned to port by selecting *[YES]* or *[NO]*.
6. Select *[OK]* if it is safe to engage the rudder in the opposite direction.
7. You will be asked to confirm the rudder turned to starboard by selecting *[YES]* or *[NO]*.
8. Dockside calibration is now complete, select *[Continue]*.

Note:

If you confirmed a “NO” response for the rudder movement to both port and starboard, the wizard will exit. It is possible that the steering system did not move the rudder in any direction, and it will be necessary to check the steering system before completing the Dockside wizard procedure again.

Important:

If you have not already done so, now set your Hard-over time using the following instructions: [Setting the hard-over time](#)

Compass linearization — Evolution autopilots

The EV sensor’s internal compass needs to compensate for local and the Earth’s magnetic fields. This is achieved using an automatic process known as linearization.

Initial linearization

When the EV sensor is first installed and powered-up (or after a factory reset or compass restart) linearization is required. When linearization is in progress bar is displayed in the Autopilot settings page: *[Homescreen > Settings > Autopilot]*.

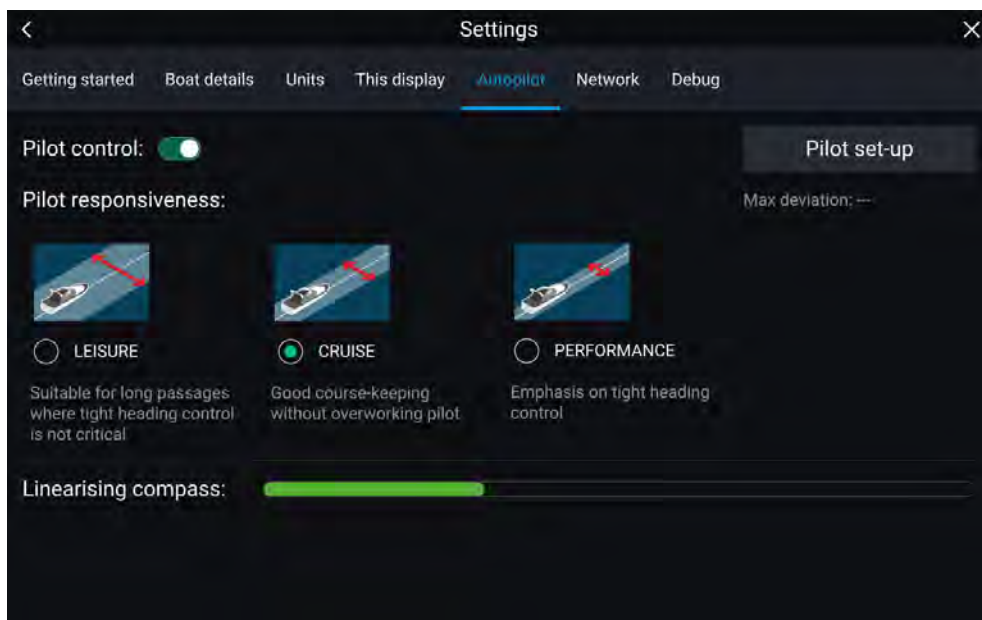

The linearization process will start automatically after your vessel has turned approximately 100° at a speed of between 3 –15 knots. Linearization requires no user input, however at least a 270° turn is required before linearization can complete. The progress bar will fill to indicate progress, the progress bar will turn Red if the process is paused or otherwise interrupted. Time it takes to complete the linearization will vary according to the characteristics of the vessel, the installation environment of the EV unit, and the levels of magnetic interference at the time of conducting the process. Sources of significant magnetic interference may increase the time required to complete the linearization process. Examples of such sources include:

- Marine pontoons
- Metal-hulled vessels
- Underwater cables

You can speed-up the linearization process by completing a full 360° turn (at a speed of 3 – 15 knots). You can also restart the linearization process at any time by selecting the *[Restart Compass]* from the Pilot set-up menu: *[Homescreen > Settings > Autopilot > Pilot set-up]*.

Once the initial linearization is completed the Maximum compass deviation value is displayed under the *[Pilot set-up]* button on the Autopilot settings page.

Compass deviation

If the reported deviation is 45° or higher, it is highly recommended that the EV sensor is moved and re-installed in a location which is subject to less magnetic interference.

Note:

If “- -” is displayed as the Deviation value, it means that linearization has not been successfully completed yet.

Check the compass heading data

As part of the autopilot system commissioning process, it is recommended that you check the compass heading value displayed, against a good known heading source on various headings.

Note:

Once the linearization process has completed, it is possible that the heading value may have a slight offset of 2 to 3 degrees. This is common where installation space is limited, and the EV sensor cannot be properly aligned to the vessel's longitudinal axis. In this case, it is possible to manually adjust the *[Compass offset]* value.

The compass offset can be adjusted from the Pilot set-up menu: *[Homescreen > Settings > Autopilot > Pilot set-up > Compass offset]*.

Important:

Do NOT rely on the reported heading until compass linearization and alignment is complete.

System monitoring and adaptation

To ensure optimum performance, after the initial linearization process is complete the EV continues to monitor and adapt the compass linearization to suit current conditions.

If the conditions for linearization are less than ideal, the automatic linearization process temporarily pauses until conditions improve again. The following conditions can cause the linearization process to temporarily pause:

- Boat speed < 3 knots.

- Boat speed > 15 knots.
- Rate-of-turn is too slow.
- Significant magnetic interference is present.

Compass lock

Once you are satisfied with the compass accuracy, you can lock the setting to prevent the system from completing a further automatic linearization in the future.

This feature is particularly useful for vessels in environments that are exposed to strong magnetic disturbances on a regular basis (such as offshore wind farms or very busy rivers, for example). In these situations it may be desirable to use the Compass lock feature to disable the continuous linearization process, as the magnetic interference may build a heading error over time.

Note:

The compass lock may be released at any time, to allow the compass continual monitoring and adaptation to re-commence. This is particularly useful if planning a long voyage. The earth's magnetic field will change significantly from one geographical location to another, and the compass can continually compensate for the changes, ensuring you maintain accurate heading data throughout the voyage.

Locking the compass

Follow the steps below to lock the compass linearization.

From the Pilot set-up menu: *[Homescreen > Settings > Autopilot > Pilot set-up]*.

1. Select the *[Compass Lock]* toggle option so that it is enabled (Green)..

The compass linearization is now locked and automatic linearization will no longer be performed.

9.2 Autopilot control

Your MFD can be integrated with an Evolution autopilot system and act as the autopilot's controller. Please refer to the documentation supplied with your autopilot for details on installing and connecting your autopilot to your MFD.

Autopilot control from your MFD can be enabled and disabled from the *[Autopilot]* tab in the *[Settings]* menu: *[Homescreen > Settings > Autopilot > Pilot control]*.



1. *[Pilot icon]*— With *[Autopilot control]* enabled, the Pilot icon is displayed onscreen; selecting the icon displays the Pilot sidebar. When the Autopilot is engaged the Pilot icon is replaced with the Disengage pilot icon.
2. *[Pilot sidebar]*— The Pilot sidebar provides controls and information relating to your autopilot system. With the Autopilot engaged the Pilot sidebar's content is expanded to provide further controls and information. The Pilot sidebar can be hidden by swiping the sidebar to the left. The sidebar can be displayed again by swiping from the left of the screen towards the center of the screen.



Warning: Maintain a permanent watch

Always maintain a permanent watch, this will allow you to respond to situations as they develop. Failure to maintain a permanent watch puts yourself, your vessel and others at serious risk of harm.



Warning: Autopilot usage

Autopilots navigate a preset course and do NOT respond to hazards automatically. The operator must remain at the helm at all times and be ready to avoid hazards and warn passengers of course changes.

Engaging the autopilot — Locked heading

With Autopilot control enabled:

1. For Wheel and Tiller pilots, engage the mechanical drive by either engaging the wheel drive's clutch or attaching the pushrod onto the tiller pin.
2. Select the *[Autopilot icon]*.
The Pilot sidebar is displayed.
3. Select *[Steer to Hdg]*.
4. Select *[Engage pilot]*.

Engaging the autopilot — Navigation

With Autopilot control enabled:

1. For Wheel and Tiller pilots, engage the mechanical drive by either engaging the wheel drive's clutch or attaching the pushrod onto the tiller pin.
2. Initiate a Goto or Follow from the chart app.
3. Select the *[Autopilot icon]*.
The Pilot sidebar is displayed.
4. Select *[Steer to Nav]*.
5. Select either *[Engage pilot]* or if a cross track error exists then select *[ALONG route leg]* or *[DIRECT from here]*.

Selecting [ALONG route leg] will steer along the original track.

Selecting [DIRECT from here] will plot a new track from your current position to the destination.

Engaging and disengaging the autopilot - physical buttons

The process for engaging your autopilot using the physical buttons available on a RMK remote keypad, Axiom® Pro or Axiom® 2 Pro is shown below.

1. Press and hold the *[Pilot]* button to engage the autopilot in Locked heading mode.
2. Press the *[Pilot]* button again to disengage the autopilot.

Disengaging the autopilot

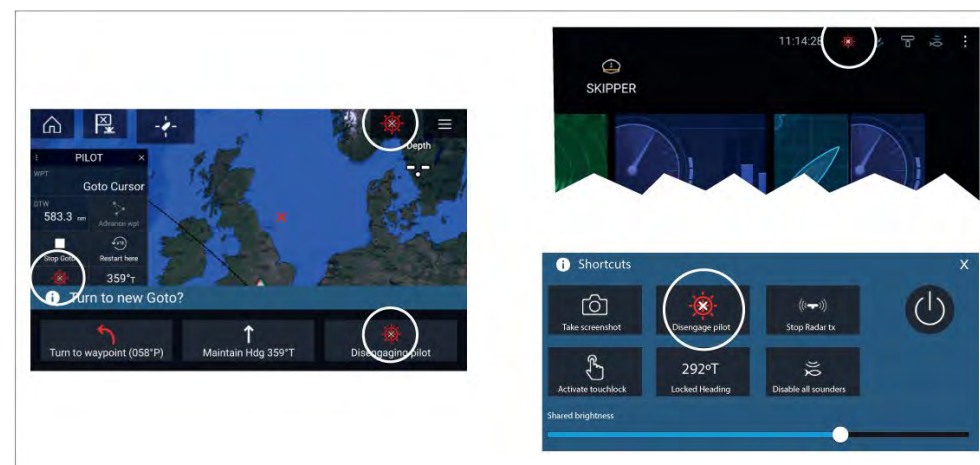

You can disengage your autopilot at any time by selecting the *[Disengage pilot icon]*.

The *[Disengage pilot icon]* is available in all apps. It is also available on the Pilot sidebar, in Pilot pop up messages, on the Homescreen and on the Shortcuts page.

9.3 Pilot sidebar

Depending on the state of your autopilot the following information and controls are available on the Pilot sidebar.



Note: The Pilot sidebar is controlled using the Touchscreen.



Pilot sidebar — Standby

1	<i>[Sidebar selection]</i> Enables you to switch between Pilot and Data sidebars.
2	<i>[Close]</i> Closes the Pilot sidebar.
3	<i>[Steer to Hdg]</i> Enables you to engage the autopilot in locked heading (Auto) mode.
4	<i>[Steer to Nav]</i> Enables you to engage the autopilot in Navigation (Track) mode.
5	<i>[Pilot status]</i> Provides the status of the autopilot.
6	<i>[Rudder bar]</i> Provides visual indication of rudder position.
7	<i>[Heading]</i> Displays your autopilot's current locked heading. Selecting displays the Locked Heading adjustment pop-over.

8	<i>[-1°]</i> Selecting will adjust your locked heading by minus 1 degree.
9	<i>[+1°]</i> Selecting will adjust your locked heading by plus 1 degree.
10	<i>[-10°]</i> Selecting will adjust your locked heading by minus 10 degrees.
11	<i>[+10°]</i> Selecting will adjust your locked heading by plus 10 degrees.
12	<i>[Disengage]</i> Selecting will disengage your autopilot.
13	<i>[Steer to Nav]</i> Selecting will engage your autopilot in Navigation mode.
14	<i>[Pilot state]</i> Displays the current state / mode of your autopilot.
15	<i>[Destination]</i> Displays your current destination.
16	<i>[User customizable data]</i> Displays user customizable data. Select to customize data.
17	<i>[Advance wpt]</i> Selecting will advance your destination to the next waypoint in the current route.
18	<i>[Stop Route] / [Stop Goto]</i> Selecting will stop current navigation.
19	<i>[Restart here]</i> Selecting will restart the cross track error (XTE) at your current location.
20	<i>[Disengage]</i> Selecting will disengage your autopilot.
21	<i>[Steer to Hdg]</i> Selecting will switch your autopilot to Locked heading mode.
22	<i>[Pilot state]</i> Displays the current state / mode of your autopilot.

9.4 Pilot Version keypad LED status (Axiom® 2 Pro only)

The *Pilot Version* lower keypad on an Axiom® 2 Pro display includes an Autopilot status LED.

LED indication	Status and required action
	Solid green = Autopilot active/on.
	Off = Autopilot in standby.
	Flashing red = Autopilot calibrating, Autopilot error.

9.5 Pilot pop-up

During active navigation, when you reach your current destination the Pilot pop-up is displayed.

Goto

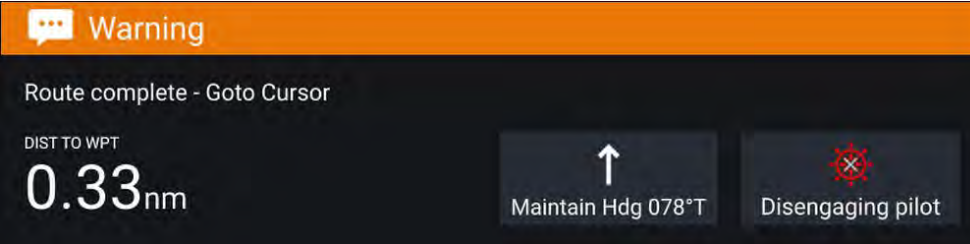

When performing a Goto the Pilot pop-up provides options to disengage the autopilot or to maintain the current course in Locked heading mode.

Follow

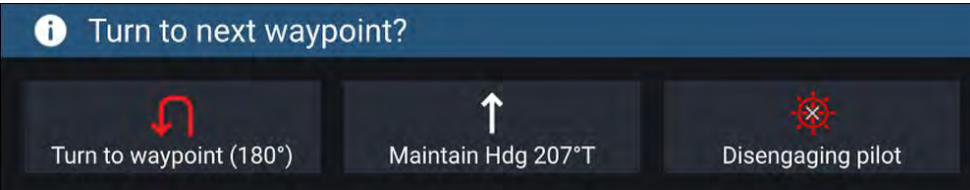

When following a Route the Pilot pop-up provides options to make the required turn to the next waypoint, disengage the autopilot or to maintain the current course in Locked heading mode.

9.6 Autopilot Control — Pilot set-up menu

Menu item and description	Options
<p><i>[Vessel hull type]</i> Selecting the hull type that is the closest match for your vessel provides optimum steering performance.</p>	<ul style="list-style-type: none"> • <i>Sail</i> • <i>Sail (slow turn)</i> • <i>Sail Catamaran</i> • <i>Power</i> • <i>Power (slow turn)</i> • <i>Power (fast turn)</i>
<p><i>[Drive type]</i> Selecting the drive type that matches your vessel's drive will provide optimum drive performance.</p>	List of drives compatible with your ACU.
<p><i>[Compass offset]</i> Adjust the Compass offset so that your autopilot's heading matches the ship's compass. The display of autopilot heading data requires a second networked MFD or pilot controller. Compass offset will be adjusted automatically during the Align compass to GPS procedure.</p>	<ul style="list-style-type: none"> • -10° to +10° • 0° (default)
<p><i>[Speed input]⁽¹⁾</i> Selects the source for speed data.</p>	<ul style="list-style-type: none"> • <i>Auto (default)</i> • <i>Water speed (STW)</i> • <i>SOG</i> • <i>Default cruise speed</i>

Menu item and description	Options
<i>[Cruise speed]</i> ⁽¹⁾ Set the Cruise speed value to your vessel's typical cruising speed.	<ul style="list-style-type: none"> • 4.0kts to 60.0kts
<i>[Calibration lock]</i> The calibration lock is used to lock out specific calibration settings which if changed may require recommissioning of the autopilot system. If your system has been dealer installed then the lock may be turned on.	<ul style="list-style-type: none"> • On (default) • Off
<i>[Dockside wizard]</i> Dockside calibration must be carried out before using your autopilot for the first time. The Dockside wizard guides you through the dockside calibration process. The steps included in the dockside wizard are dependent on whether you have a rudder reference transducer fitted to your vessel.	<ul style="list-style-type: none"> • Drive type • Rudder limit • Align rudder • Hard over time • Rudder drive check
<i>[Restart compass]</i> Select to restart the compass linearization procedure.	<ul style="list-style-type: none"> • Start • Cancel • Disengage pilot
<i>[Compass lock]</i> Locks the compass linearization so that further automatic linearization is not performed.	<ul style="list-style-type: none"> • On • Off (default)

Menu item and description	Options
<i>[Align compass to GPS]</i> ⁽¹⁾ Follow the onscreen instructions to align your compass with your GPS heading. If your system has a GPS connected to your data network (SeaTalk, SeaTalkng or NMEA), the autopilot is tuned to the GPS heading while you steer to a known magnetic heading. This step provides a rough alignment and minimizes the amount of compass fine tuning required. As part of the align to GPS process, the autopilot system will compare the average heading with the average COG (Course Over Ground) value reported by the source of GPS data, and set an offset value so that the heading matches the COG value provided by the GPS.	<ul style="list-style-type: none"> • Start • Cancel • Disengage pilot
<i>[Pilot factory reset]</i> Resets your autopilot's settings to factory default values.	<ul style="list-style-type: none"> • Yes • No
<i>[CCU debug level]</i> ⁽¹⁾ Sets a debug value for troubleshooting purposes. The debug level should only be set when requested by Technical Support as part of a troubleshooting process.	<ul style="list-style-type: none"> • 0 to 63
<i>[ACU debug level]</i> ⁽¹⁾ Sets a debug value for troubleshooting purposes. The debug level should only be set when requested by Technical Support as part of a troubleshooting process.	<ul style="list-style-type: none"> • 0 to 63
<i>[Rudder damping]</i> ⁽¹⁾ Rudder damping is used to prevent the autopilot from "hunting" maneuvers. Always use the lowest acceptable value. For more information, refer to: p.146 – Rudder damping levels and deadband angles	<ul style="list-style-type: none"> • 1 to 9 • 3 (default)
<i>[Auto turn angle]</i> ⁽¹⁾ Determines the amount of course change when performing an auto turn.	<ul style="list-style-type: none"> • 10° to 125° • 90° (default)
<i>[Power steering]</i> ⁽³⁾ Determines the behavior of the Rotary or Joystick.	<ul style="list-style-type: none"> • Off (default) • Proportional • Bang Bang

Menu item and description	Options
<i>[Reverse rudder ref]</i> ⁽³⁾ Inverts the rudder reference display graphic.	<ul style="list-style-type: none"> • On • Off
<i>[Motor phasing]</i> ⁽¹⁾ Switches the polarity of your drive motor. Use if your drive polarity is inverted.	<ul style="list-style-type: none"> • A • B
<i>[Rudder offset]</i> ⁽³⁾ Adjust to specify the rudder offset from amidships.	<ul style="list-style-type: none"> • -10° to $+10^{\circ}$ • 30° (default)
<i>[Rudder limit]</i> Specifies how far the rudder can move before hitting its end stops. The value should be set to approximately 5° less than your maximum rudder angle.	<ul style="list-style-type: none"> • 10° to 50° • 30° (default)
<i>[Hard over time]</i> Specifies the time it takes for the rudder to move from hard port to hard starboard or vice versa. The default value is determined by your <i>[Drive type]</i> selection.	<ul style="list-style-type: none"> • 1 to 100.0 seconds
<i>[Gybe inhibit]</i> ⁽²⁾ When set to <i>[Prevent Gybe]</i> the autopilot will prevent you from performing an Auto tack away from the wind.	<ul style="list-style-type: none"> • Allow Gybe • Prevent Gybe
<i>[Wind data type]</i> ⁽²⁾ Selects whether wind data is True or Apparent.	<ul style="list-style-type: none"> • Apparent • True
<i>[Wind shift alarm]</i> ⁽²⁾ Enables and disables the Wind shift alarm.	<ul style="list-style-type: none"> • On • Off

Note:

- (1) Option not available when *[Calibration lock]* is *[On]*.
- (2) Only available when Vessel hull type is set to a Sailing vessel.
- (3) Only available when a rudder reference transducer is connected.

9.7 Rudder damping levels and deadband angles

For autopilot systems which include a rudder angle reference sensor / transducer, rudder damping is used to prevent Evolution autopilot system over-activity, characterized by “hunting” maneuvers. A number of rudder damping levels are available to address this behavior. Rudder damping levels relate to “deadband angles”, and can be configured using your autopilot control head (e.g. p70s/p70Rs or MFD). A higher damping level is intended to eliminate pilot and helm over-activity.

Typically, the appropriate rudder damping level is the lowest acceptable value. However, it is important to be aware that the rudder damping scaling has been changed in recent versions of ACU units, which include newer processor and software versions (these units can be identified with an “A” appended to their SKU).

Important:

The rudder damping levels can have a significant impact on your autopilot performance. If you are unsure as to how to adjust these settings to best suit your autopilot system, please refer to your dealer or Raymarine product support.

The following table lists the rudder damping levels and deadband angles that are available with both old and new versions of the ACU software:

Rudder damping level	Existing Deadband angle (ACU-100, -150, -200, -400)	Existing Deadband angle (ACU-300)	New Deadband angle (ACU software version v3.11 or later)
1	0.1°	0.15°	0.1°
2	0.2°	0.30°	0.2°
3	0.3°	0.45°	0.3°
4	0.4°	0.60°	0.4°
5	0.5°	0.75°	0.7°
6	0.6°	0.9°	0.9°
7	0.7°	1.05°	1.1°

Rudder damping level	Existing Deadband angle (ACU-100, -150, -200, -400)	Existing Deadband angle (ACU-300)	New Deadband angle (ACU software version v3.11 or later)
8	0.8°	1.20°	1.6°
9	0.9°	1.35°	2.2°

It’s important to check the rudder damping level currently configured on your autopilot control head, to ensure it matches your needs. The rudder damping value should be increased one level at a time until the autopilot stops hunting.

Adjusting the Rudder Damping level

Use the following menu path to adjust the Rudder Damping level:

1. [*Homescreen > Settings > Autopilot > Advanced settings > Rudder Damping*].

CHAPTER 10: TROLLING MOTOR CONTROL

CHAPTER CONTENTS

- 10.1 Trolling motor integration — page 148
- 10.2 Trolling motor control overview — page 148
- 10.3 Manual control — page 150
- 10.4 Anchor mode — page 150
- 10.5 Hold heading — page 151
- 10.6 Navigation mode — page 152
- 10.7 Alarms and limits — page 153

10.1 Trolling motor integration

The trolling motor requires an NMEA 2000 gateway which is connected to the same network as the display(s).

Currently integration is available for Rhodan trolling motors manufactured after January 2017 that are connected to the NMEA 2000 network using the Rhodan gateway module.

A firmware update may be required for the Rhodan trolling motor and a software update may be required for gateways manufactured before October 2023.

The Trolling sidebar will report if incompatible software is detected. If this occurs, contact Rhodan to obtain a software/firmware update dongle.

Axiom/Axiom 2 display(s) must be running LightHouse™ 4, version 4.5 or later.

SeaTalkng® connection diagram

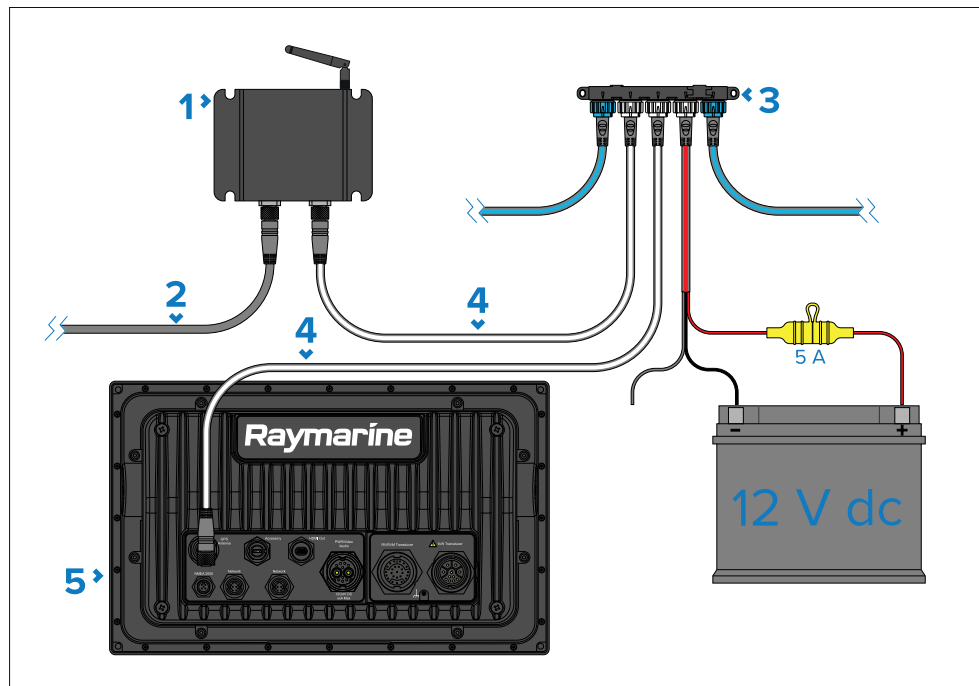

1. Rhodan gateway module.
2. DeviceNet connection to Trolling motor.
3. SeaTalkng network.

4. SeaTalkng to DeviceNet adaptor cables
5. Axiom/Axiom 2 display running LightHouse™ 4, version 4.5 or later.

Note:

The diagram depicts connection using a Raymarine SeaTalkng® network. A DeviceNet network could be used in a similar way.

Autopilot integration

The Trolling motor can be integrated on a system that includes an autopilot, such as the Evolution™ autopilot.

If the autopilot is engaged whilst the Trolling motor is in use, the Trolling motor will automatically drop to standby mode.

The autopilot must be disengaged/in standby to enable selection of Trolling motor modes.

Wireless fob integration

When using the trolling motor's wireless fob, the display's Trolling sidebar will automatically update to show the selected mode.

When using a mode that is not available on the display, e.g.: when using the Trolling motor's Route mode to follow a route stored on the trolling motor, the Sidebar will be placed in Standby and the Motor Status will be *[DIRECT CONTROL]*.

When under direct control, the sidebar can be used to take control and change the mode of the Trolling motor.

10.2 Trolling motor control overview

A compatible Trolling motor can be integrated with the display so that the Trolling motor can be controlled using the dedicated Trolling sidebar. The Trolling sidebar provides controls which enable you to manoeuvre your boat over short distances, or hold position without using an anchor.

The Trolling sidebar will be available on all networked displays when a compatible Trolling motor is detected on the network. The controls will be disabled when the Trolling motor is in the 'Stowed' position. The controls will be enabled when the Trolling motor is 'Deployed'.

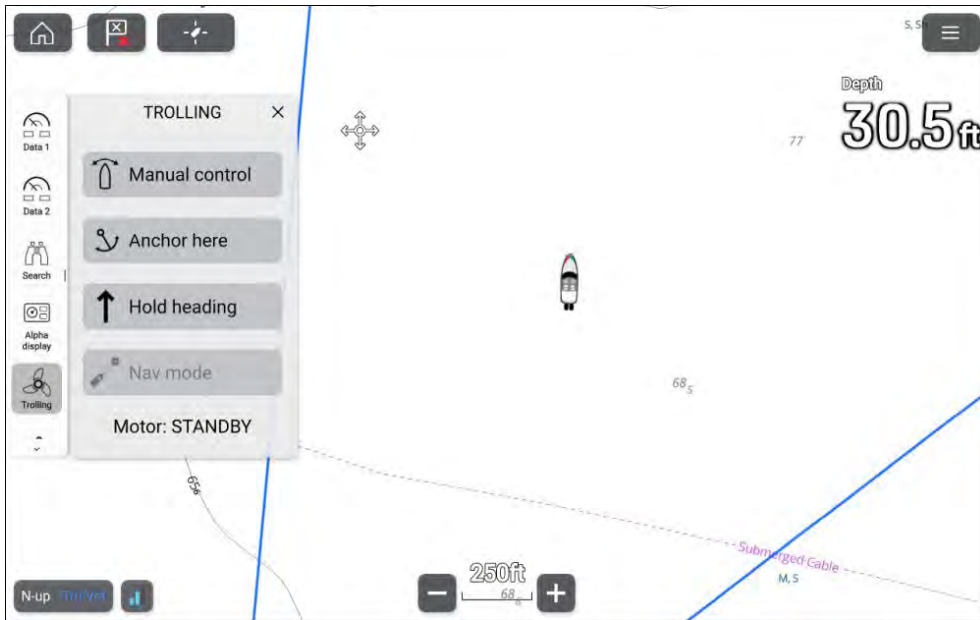

The Trolling sidebar provides controls for the following modes:

- Manual control mode
- Anchor mode
- Hold heading mode
- Navigation mode

Note:

Trolling motors usually use built-in sensors for position and heading; the sensor data is not shared with the display. On larger boats where the boat's GNSS (GPS) receiver is several meters from the Trolling motor, there may be an offset when performing a "Goto" or following a route.

The system will remember the last networked display that the Trolling motor was controlled from, and will automatically open the Trolling sidebar on that display the next time the Trolling motor is 'Deployed'. However, if the autopilot is engaged when the Trolling motor is deployed, the sidebar will not open automatically.

Anchor mode, Hold heading and Navigation modes require the Trolling motor to have its own GPS position fix. These modes will be disabled if the Trolling motor has no position fix.

Selecting a mode will initiate that mode on the Trolling motor and open the relevant mode sidebar.

The Trolling mode sidebars provide controls similar to the controls available on the trolling motor wireless fob.

Steering controls

Steering controls adjust the Trolling motor's heading.

Thrust/Speed controls

- Thrust provides direct control of motor thrust. Negative thrust is only available in Manual control mode.
- Speed sets a desired Speed Over Ground (SOG).

Note:

- When using your boat's engine(s), the Trolling motor should be correctly 'stowed' to prevent damage to the Trolling motor.
- If the Trolling motor reports an *over temperature* or *over current* fault, Anchor mode and Navigation mode will be disabled.

10.3 Manual control

Manual control enables you to control the direction and thrust level of the Trolling motor.

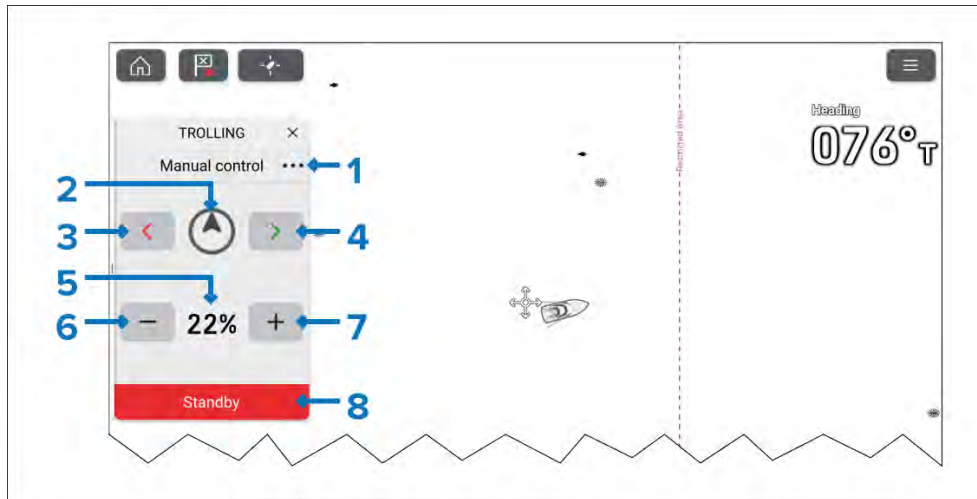

The Manual control sidebar includes the following controls:

1. Menu — Select the three dots to access the available Trolling motor modes.
2. Motor direction indicator — Shows the angle of the Trolling motor referenced to boat heading.
3. Steer port.
4. Steer starboard.
5. Current thrust percentage.
6. Decrease thrust.
7. Increase thrust.
8. Standby.

Thrust increments are determined by the Trolling motor. The thrust range is from -50% to 100%.

Selecting the steering buttons will adjust the heading in 5 degree increments.

You can select Standby at any time to place the Trolling motor into standby mode.

Note:

Increments of speed and steering are commanded by the Trolling motor and as such the stated increments could be different or change.

10.4 Anchor mode

Anchor mode acts as a virtual anchor and automatically controls steering and thruster speed to maintain the boat's position. In anchor mode, the bow should maintain position, however the boat may swing around depending on conditions.

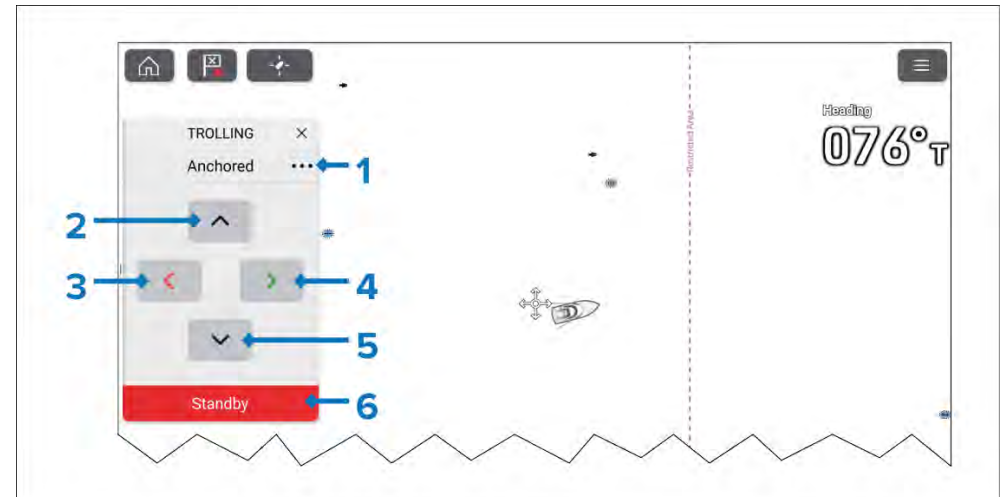

The Anchor mode sidebar includes the following controls:

1. Menu — Select the three dots to access the available Trolling motor modes.
2. Forwards.
3. Left.
4. Right.
5. Backwards.
6. Standby.

Selecting the directional controls (Up, Down, Left, Right) will move ('jog') the anchor location in 5 foot increments, relative to the boat's heading. E.g.: Selecting the Right button once will move the anchor location 5 feet to the right of the boat's bow.

Important:

In anchor mode, the trolling motor will operate causing the bow of the boat to move as needed to maintain its location. Unexpected movement of the boat may cause imbalance. Be cautious when using this mode until you are familiar with how the system works.

Note:

Increments of speed and steering are commanded by the Trolling motor and as such the stated increments could be different or change.

You can select Standby at any time to place the Trolling motor into standby mode.

10.5 Hold heading

Hold heading mode aligns the motor's heading with the boat's heading and locks the motor in position so that thrust is in a fixed direction. Actual boat heading and COG may differ to the motor's fixed direction due to tide and wind conditions.

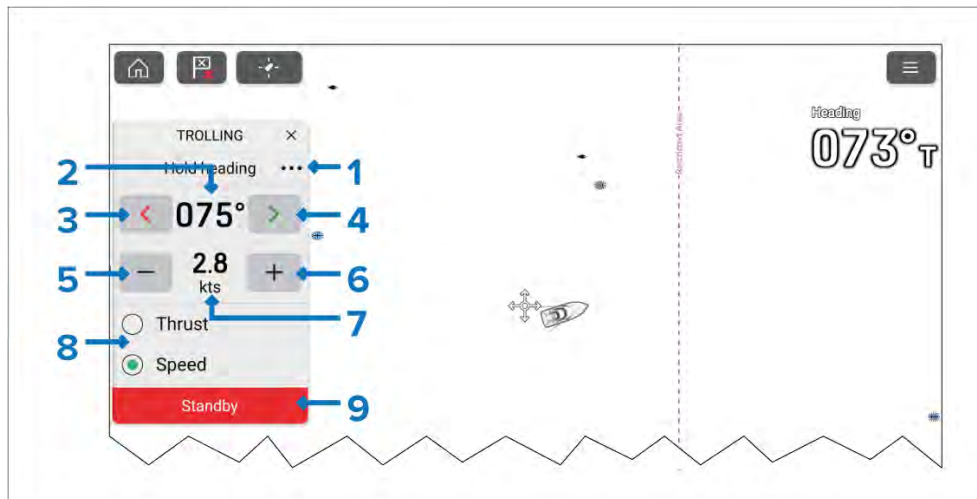

The Hold heading sidebar includes the following controls:

[Trolling motor control](#)

1. Menu — Select the three dots to access the available Trolling motor modes.
2. Heading (of the trolling motor).
3. Steer port.
4. Steer Starboard.
5. Decrease thrust/speed.
6. Increase thrust/speed.
7. Current thrust percentage/speed.
8. Thrust/Speed selection.
9. Standby.

Thrust increments are determined by the Trolling motor. The thrust range is from 0% to 100%, reverse thrust is not available in Hold heading mode. The default thrust for Hold heading mode is 40%. When switching from Manual control the Trolling motor will retain its previous speed, otherwise it will gradually ramp up to 40%.

If required, Thrust can be switched to speed by selecting the Speed option.

Important:

In Hold heading mode the thrust level is user selected. In extreme wind or current it is necessary for the user to select a speed setting with adequate thrust to remain on course.

Selecting the steering buttons will adjust the 'held' heading in 5 degree increments.

You can select Standby at any time to place the Trolling motor into standby mode.

Note:

Increments of speed and steering are commanded by the Trolling motor and as such the stated increments could be different or change.

10.6 Navigation mode

Navigation mode allows the Trolling motor to follow any active navigation set by the display (i.e.: performing a “Goto”, or following a route).

Navigation mode is only available when the display has active navigation. When the Trolling motor is deployed initiating a “Goto” or following a route, it will display a prompt asking if you wish to use the Trolling motor. Selecting “yes” will automatically enable Navigation mode.

Note:

- To initiate a “goto”, the waypoint must be within 1 kilometer of your boat
- When following a route, each waypoint must be within 1 kilometer from the previous waypoint.
- When following a route, if the next waypoint is over 1 kilometer away, the Trolling motor will switch to Manual control with 0% thrust.

Example goto cursor notification

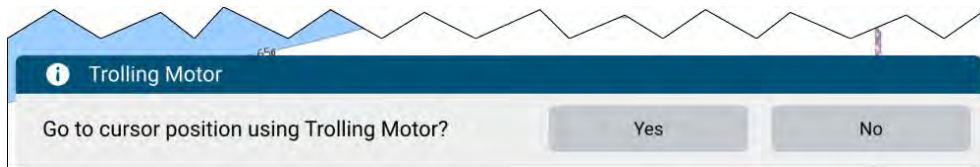

When following a route, the Trolling motor will automatically advance to the next waypoint on waypoint arrival.

The normal waypoint arrival notification does not apply when using Navigation mode.

When the destination waypoint is reached, the Trolling motor will automatically switch to Anchor mode to maintain the boat’s position at the destination point.

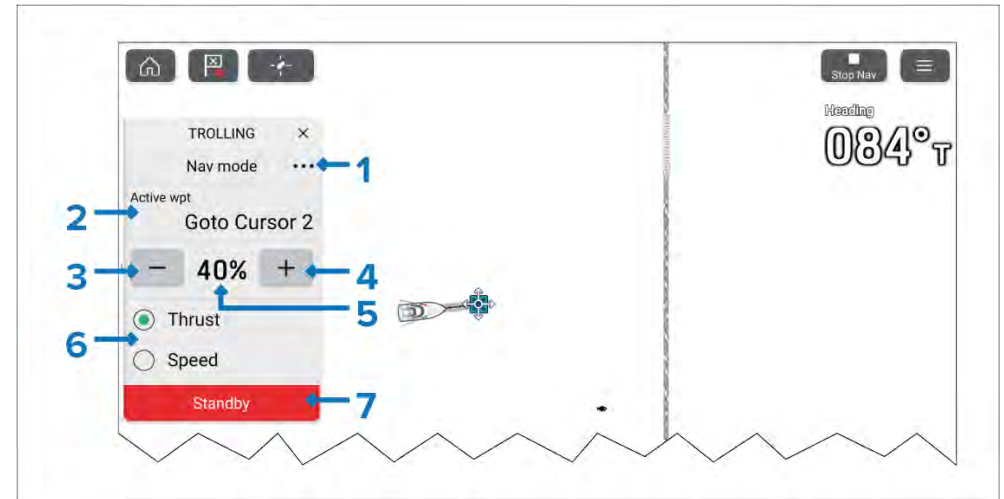

The Navigation sidebar includes the following controls:

1. Menu — Select the three dots to access the available Trolling motor modes.
2. Active waypoint name.
3. Decrease thrust/speed.
4. Increase thrust/speed.
5. Current thrust percentage/speed.
6. Thrust/Speed selection.
7. Standby.

Thrust increments are determined by the Trolling motor. The thrust range is from 0% to 100%, reverse thrust is not available in Navigation mode. The default thrust for Navigation mode is 40%. When switching from Manual control, the Trolling motor will retain its previous speed, otherwise it will gradually ramp up to 40%.

If required, Thrust can be switched to speed by selecting the Speed option.

Selecting the Thrust/speed buttons will adjust the Trolling motor’s thrust/speed in increments; 4% for thrust and 0.1 Kts for speed.

You can select Standby at any time to place the Trolling motor into standby mode.

When active navigation is cancelled on the display, the Trolling motor will automatically switch to Manual control mode.

Note:

Increments of speed and steering are commanded by the Trolling motor and as such the stated increments could be different or change.

10.7 Alarms and limits

Alarm conditions reported by the Trolling motor will trigger an alarm notification on the display.

The following alarms can be triggered on the display:

- Trolling motor's GPS fix lost.
- Over temperature.
- Over current.
- Over range. (In anchor mode, if the Trolling motor is unable to maintain position, the Over range alarm is triggered.)
- Goto distance limit. (If a requested "Goto" is more than 1 kilometer away, the Goto distance limit alarm is triggered.)

CHAPTER 11: WAYPOINTS, ROUTES AND TRACKS

CHAPTER CONTENTS

- 11.1 Waypoints — page 155
- 11.2 Routes — page 159
- 11.3 Tracks — page 164
- 11.4 Sharing Waypoints, Routes and Tracks — page 165
- 11.5 Waypoint, routes and tracks capacity — page 166

11.1 Waypoints

Waypoints are used to mark specific locations or points of interest. Waypoints can be used in the Chart, Radar and Fishfinder apps. Your MFD can store up to 10,000 waypoints which can be sorted into up to 200 waypoint groups.

You can navigate to a waypoint by selecting *[Goto]* from the Waypoint's context menu.

Waypoints can be viewed and managed from the waypoint list.

Waypoints can be customized when they are created or after they are created from the waypoint list.

Placing a waypoint using chart context menu

Waypoints can be placed in the chart app, radar app and fishfinder app from the context menu.

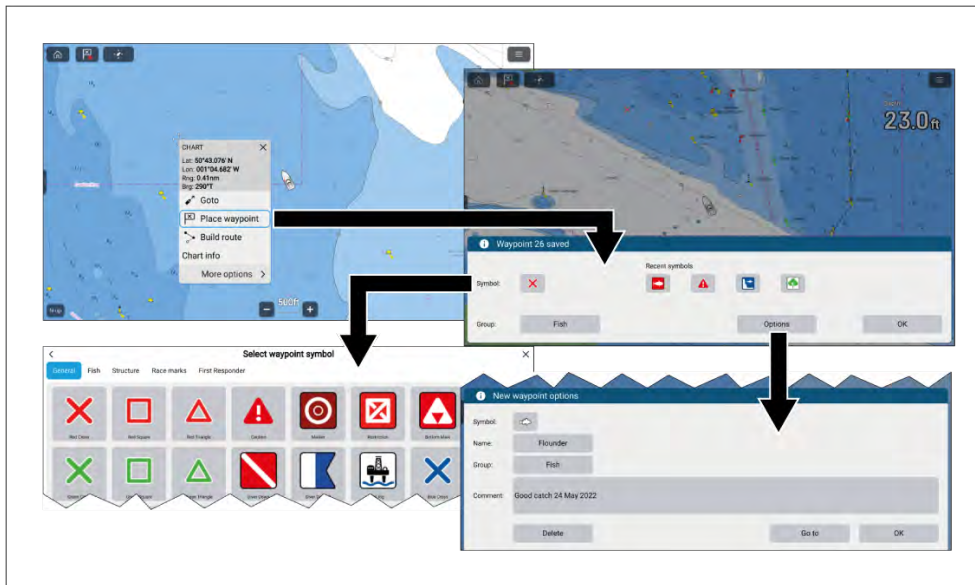

1. Select and hold the desired area onscreen.
2. Select *[Place waypoint]* from the context menu.
3. Select *[OK]* to accept the default waypoint settings, or:
4. You can select a symbol to use for the waypoint.

*You can either select a recent symbol from those shown, or select the *[Symbol]* field to select a symbol from the waypoint symbol lists.*

5. You can select the *[Group]* field to select or create a waypoint group for the new waypoint.
6. You can select *[Options]* to enter further details about the waypoint.

From the options dialog you can edit the waypoint's symbol, name, or group and also enter a comment about the waypoint.

Placing a waypoint at a specific latitude and longitude

In the chart app you can place a waypoint at a specific latitude and longitude.

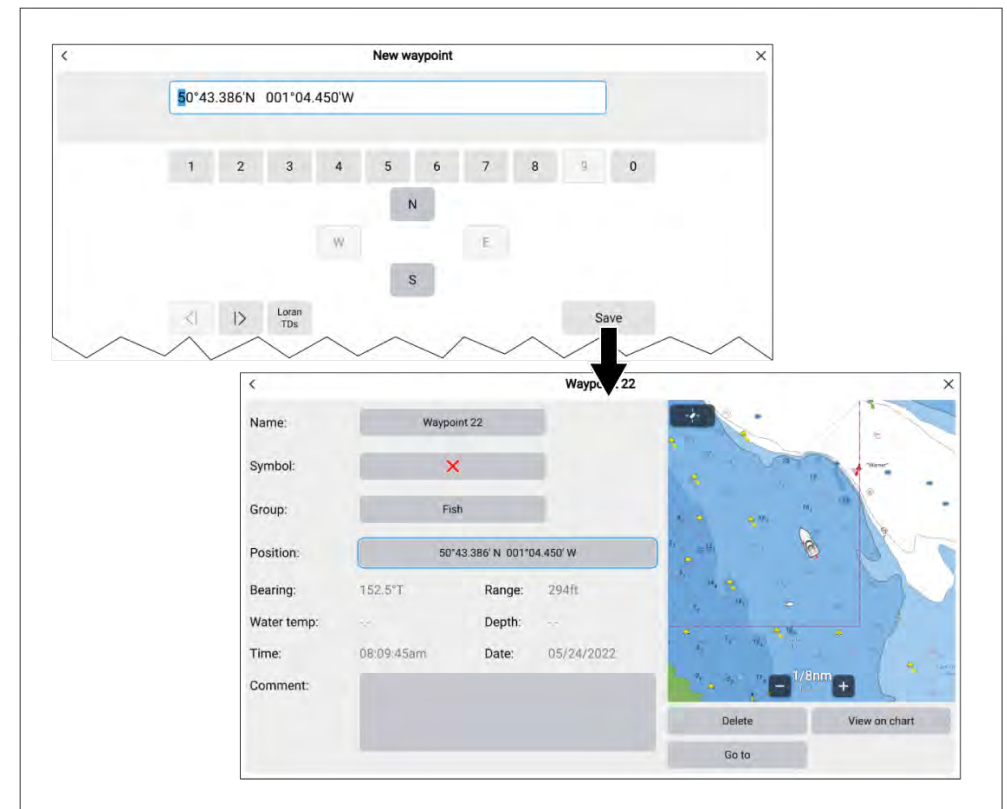

From the chart app:

1. Select the *[Menu]* icon.
2. Select *[New]*.
3. Select *[New waypoint at lat/long]*.
The Lat/long onscreen keyboard is displayed.

4. Enter the coordinates for the location you want the waypoint to be placed.

By default the coordinates will be your vessel's current location. If required you can also switch coordinates to Loran TDs (time difference lines) by selecting [Loran TDs].

5. Select [Save].

The waypoint details page is displayed where you can customize/edit the following waypoint details:

- Name
- Symbol
- Group
- Position
- Comment

From the waypoint details page you can also [Delete] the waypoint, perform a [Go to] or [View on chart].

Placing a waypoint at your vessel's location

Waypoints can be placed at your vessel's location from any app using the Waypoint icon or, the waypoint physical button. The waypoint physical button can also place a waypoint at your vessel's location from the Homescreen or when a menu is open.

The waypoint/MOB physical button is available on Axiom® Pro, Axiom® 2 Pro display or RMK-9/RMK-10 remote keypads.



1. Press and release the [Waypoint/MOB] icon located at the top of MFD app pages, or
2. Press the [Waypoint/MOB] physical button from any MFD app page, the Homescreen or whilst a menu is open.
3. Select [OK] to accept the default waypoint settings, or:
4. You can select a symbol to use for the waypoint.

You can either select a recent symbol from those shown, or select the [Symbol] field to select a symbol from the waypoint symbol lists.

5. You can select the [Group] field to select or create a waypoint group for the new waypoint.
6. You can select [Options] to enter further details about the waypoint.

From the options dialog you can edit the waypoint's symbol, name, or group and also enter a comment about the waypoint.

Waypoint management

Waypoints are managed using the Waypoint list.

The Waypoint list can be accessed from the Homescreen and from the Chart app: [Homescreen > My data > Waypoints], or [Chart app > Menu > Waypoints, routes, tracks > Waypoints].

Waypoint list

The Waypoint list is sorted into groups. Selecting a group displays a list of all the waypoints included in that group.

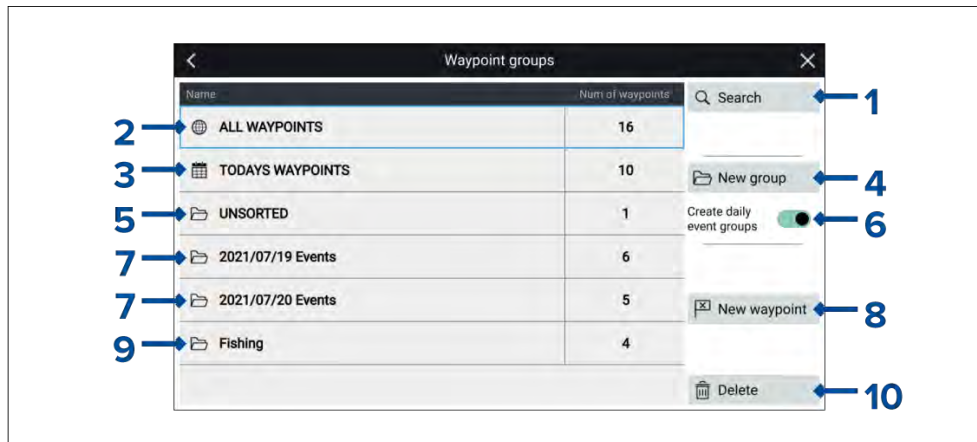

1. *[Search]*— search for waypoints by text or by symbol.
2. **ALL WAYPOINTS** — view a list of all waypoints.
3. **TODAYS WAYPOINTS** — view all waypoints created today.
4. *[New group]*— create a new waypoint group.
5. **UNSORTED** — view all waypoints not assigned to a waypoint group.
6. *[Create daily event groups]*— when enabled, waypoints are automatically saved by day into event groups. The event group folders are named using the following date formatting (YYYY/MM/DD) so that they are ordered sequentially in the list. The naming format does not change with the Date format setting of the display.
7. **Event groups** — event groups are created automatically each day when *[Create daily event groups]* is enabled.
8. *[New waypoint]*— create a new waypoint at your vessel's current location.
9. **Waypoint group** — select to view a list of all waypoints in the group.
10. *[Delete]*— select the waypoints to be deleted.

Selecting a Waypoint group from the list displays a list of all waypoints in that group.

Group list

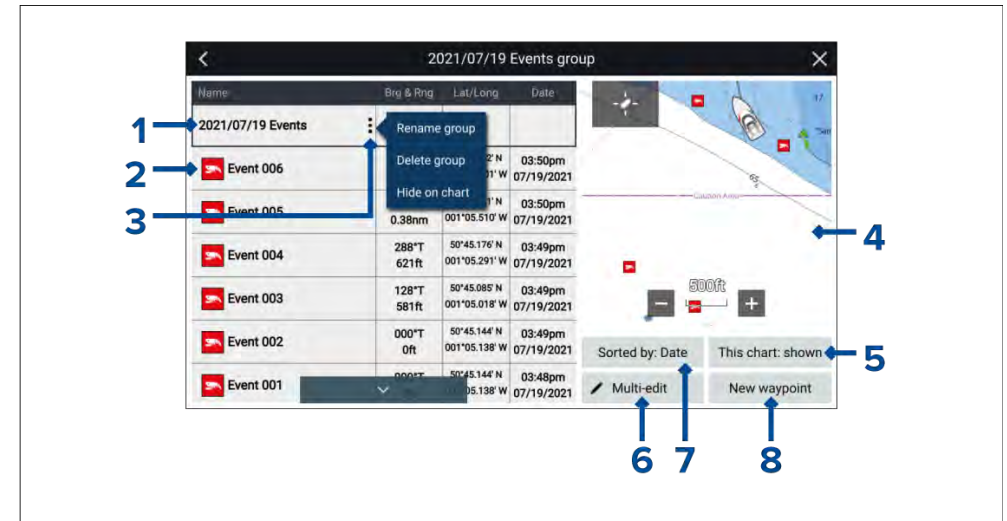

1. **Waypoint group / Event group** — name of the waypoint or event group.
2. **Waypoints** — list of waypoints in the group.
3. *[Menu]*— select to open the group pop-over menu. The following options are available:
 - *[Rename group]*— rename the group
 - *[Delete group]*— delete the group and all of its waypoints.
 - *[Hide on chart]* / *[Show on chart]*— when the waypoint list is accessed via the Chart app, this option allows you to show or hide the waypoints in the group. Hidden groups will not be displayed in the Chart app.
4. **LiveView** — When accessed via the Chart app, the LiveView pane is displayed, which shows the waypoint on the Chart, in the context of the vessel's current location. When a waypoint is selected, the LiveView will show the selected waypoint in the center of the LiveView pane.
5. *[This chart: shown]* / *[This chart: hidden]*— identifies whether the current group is shown or hidden in the Chart app. Selecting this option will switch between *hidden* and *shown*.
6. *[Multi-edit]*— change details of more than one waypoint in the group. When selected, the options under the LiveView pane change and you can select the waypoints from the list that you want to edit. The following options are available:

- *[Select all]*— selects all waypoints in the group.
 - *[Delete selected]*— deletes the selected waypoints.
 - *[Change symbol]*— changes the symbol used for the selected waypoints.
 - *[Move to another group]*— moves the selected waypoints to a different group.
7. *[Sort by]*— sort the waypoints in the group by either: *[Name]*, *[Date]*, *[Range]*, *[Symbol]* or *[Comment]*.
 8. *[New waypoint]*— creates a new waypoint at your vessel's current location.

Selecting a waypoint displays the pop-over menu. Selecting *[View waypoint details]* from the pop-over menu displays details for that waypoint.

Waypoint details

When accessed via the Chart app, the waypoint details page will include the LiveView pane, which displays the waypoints on the Chart, in the context of the vessel's current location.

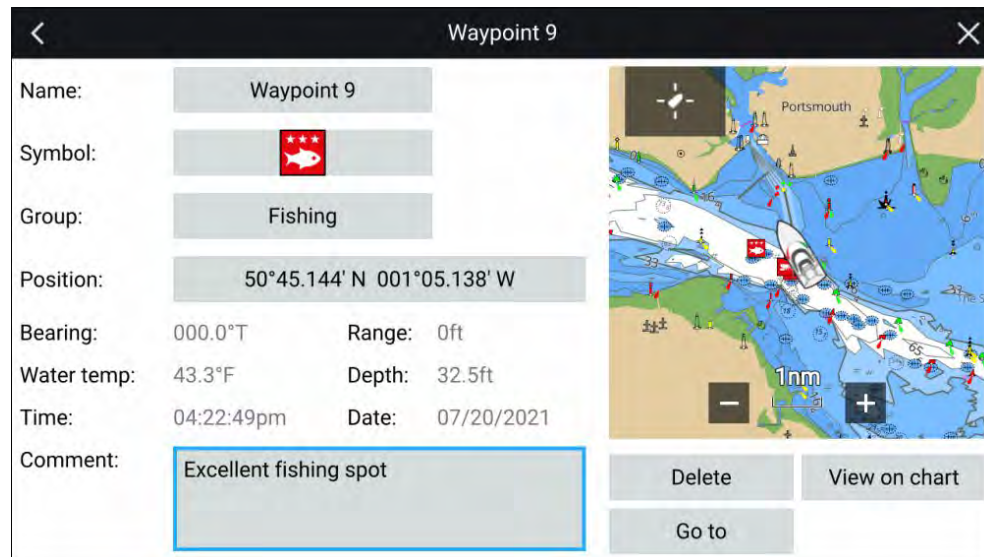

The waypoint's *[Name]*, *[Symbol]*, *[Group]*, *[Position]* and *[Comment]* can be customized by selecting the relevant field. Below the LiveView pane there are options to *[Delete]* the waypoint, set a *[Go to]*, or *[View on chart]*.

Waypoint symbols

A range of waypoint symbols is available, enabling you to use different symbols to represent different types of locations and objects.

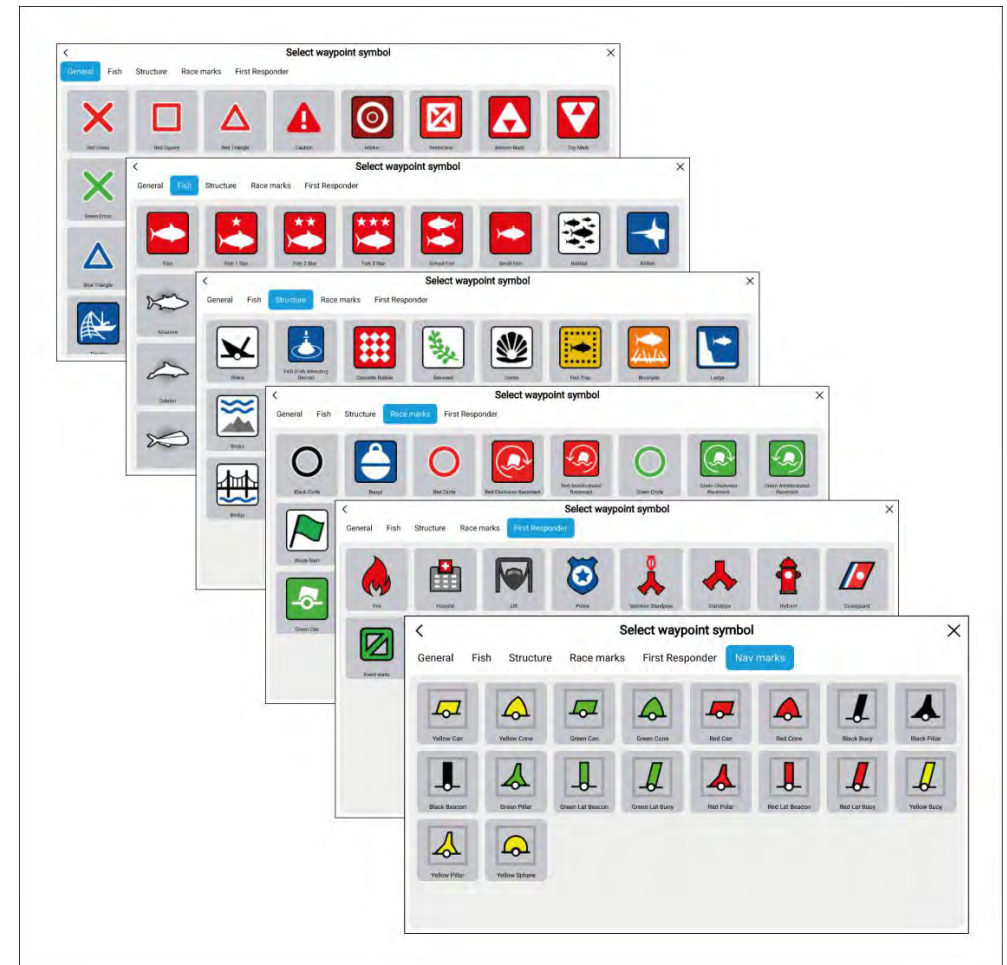

The available symbols are grouped into different lists. The available lists are:

- General
- Fish
- Structure
- Race marks
- First responder

- Nav marks

11.2 Routes

Routes are used to plan your journey in advance. You can plan your journey directly on your MFD, or at home using software capable of exporting Waypoints and Routes in standard .gpx format, such as Raymarine's Seapilot app.

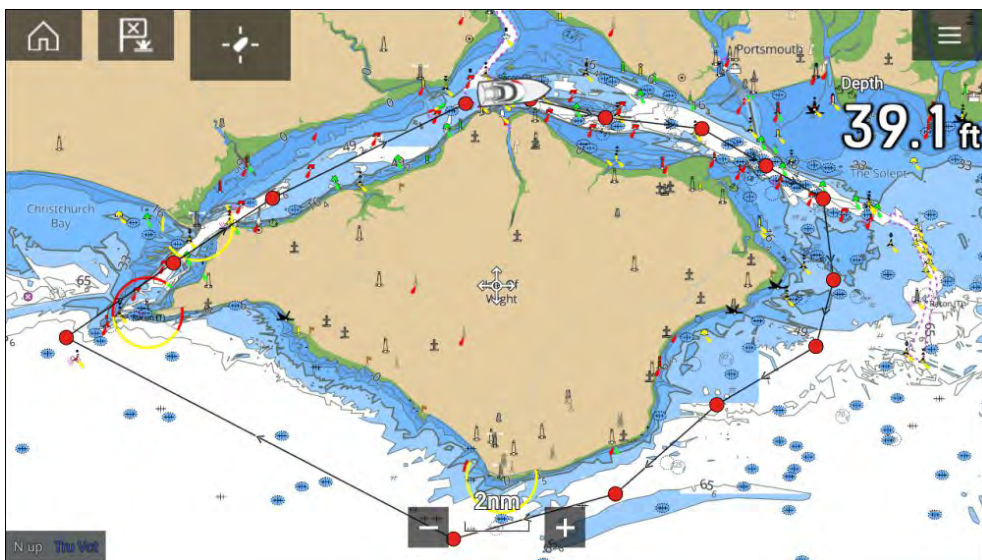

Routes consist of a number of waypoints. Your MFD can store up to 250 Routes, each Route consisting of up to 500 waypoints. The Route capacity limit is subject to your MFD's 10,000 Waypoint limit (for example, your MFD could store 20 Routes each containing 500 waypoints).

Creating a Route

Routes can be created on the MFD in the Chart app.

Note:

When creating routes ensure that the waypoints are farther apart than the distance specified in the waypoint arrival alarm settings.

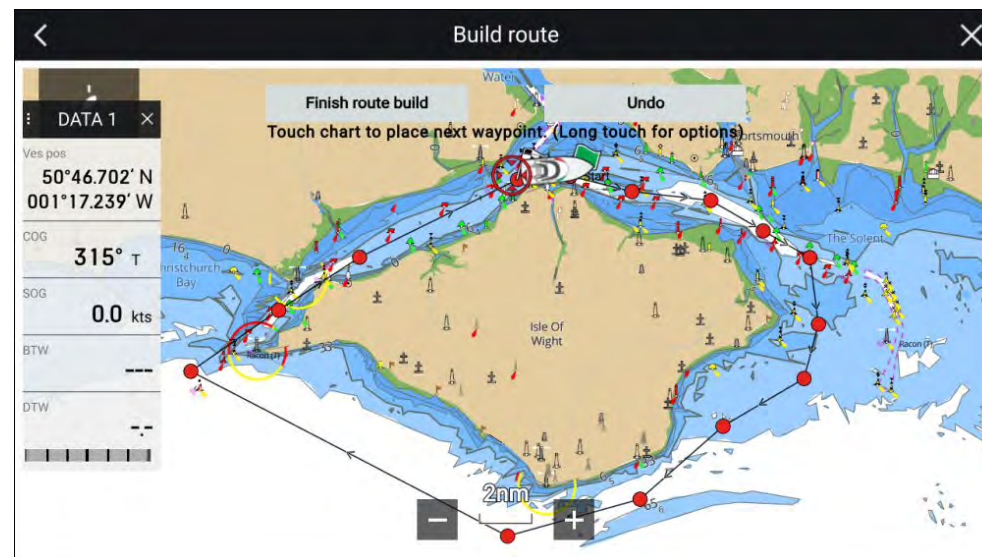

1. Select and hold on the location for the first waypoint.
2. Select *[Build route]* from the context menu.
3. Select the location for the second waypoint.
The 2 waypoints will be joined by a line, creating the first leg of your route.
4. Select the location for subsequent waypoints.

Important:

If you place a waypoint in the wrong location you can select *[Undo]* at any time to remove the last waypoint placed.

5. Check your Route will be safe to follow, you can move the waypoints in your route by dragging them to a new location.
6. When your Route is complete select *[Finish route build]*.

Route waypoint spacing

When creating routes the waypoints must be spaced far enough apart to ensure the route can be navigated successfully by your vessel. Vessel speed, turning characteristics and waypoint arrival radius will all impact how effectively a route can be navigated.

If waypoints are placed closer together than the Waypoint arrival alarm radius then waypoints in the route may be skipped.

If vessel speed is too high with closely spaced waypoints then you may pass the next waypoint before the vessel can turn.

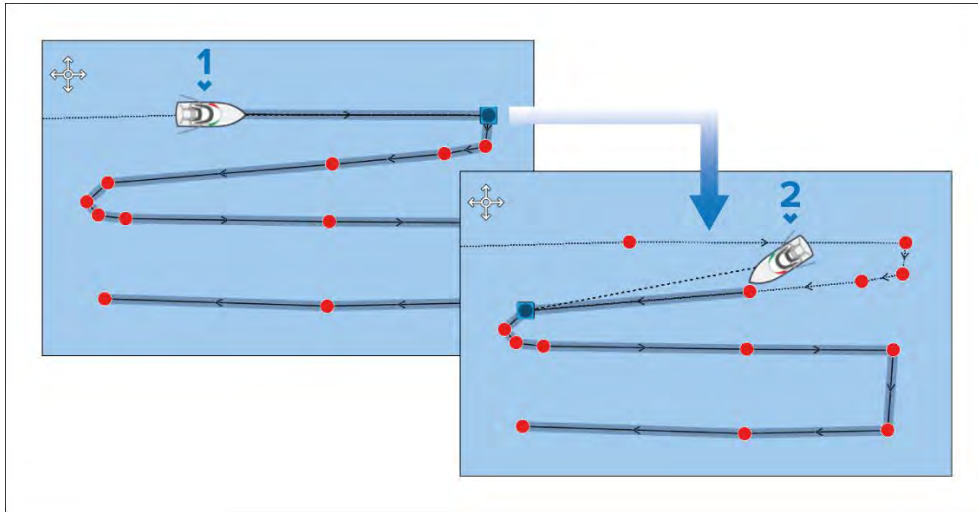

1. Vessel heading toward waypoint.
2. Vessel skips waypoints that are spaced too close together.

Route highlighting

When a route is selected or being followed, the route will be highlighted onscreen.

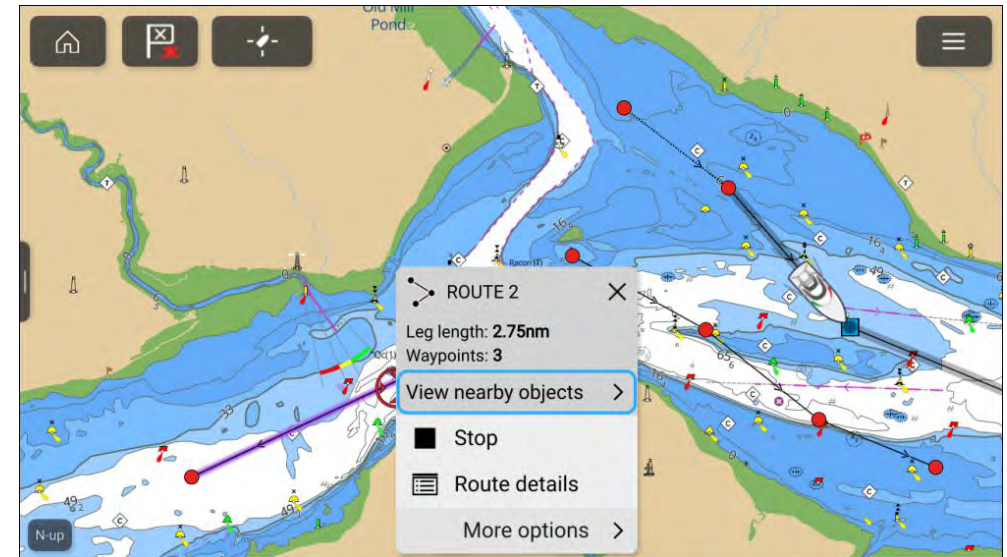

- **Followed route** — A route currently being followed has the current route leg and future route legs highlighted. The highlighting is dynamic, with highlighting removed from route legs already completed.
- **Selected route** — When you select a route onscreen with the cursor, the route is highlighted to distinguish the selected route from other routes which may be present onscreen.

Use Autorouting during route creation

Whilst building a route you can use Autorouting to automatically add a route leg to a route you have already started to create. The Autorouting features require compatible cartography.

1. Press and hold anywhere on screen and select either *[Autoroute to wpt]* or *[Autoroute to here]*.

Selecting [Autoroute to wpt] will allow you to select a waypoint from your Waypoints list to include in your route, selecting [Autoroute to here] will create a route leg to the cursor's current position.

Once an Autoroute leg has been added you can select *[Finish route build]* or add further manual or autoroute route legs.

Autoroute

Autoroute is available when using compatible cartography. Autoroute allows you to build a route automatically between a point on the chart and your vessel.



You can select any point on the Chart and from the Chart context menu select *[Autoroute to here]* or you can select *[Autoroute to]* from an existing waypoint's context menu to create a route automatically between your vessel and the chosen point.

The created route is generated by comparing data available on your cartography against the minimum safe distances specified in the *[Boat details]* menu: (*[Homescreen > Settings > Boat details]*).

Waypoints will not be placed in areas that conflict with your specified minimum safe distances. Caution symbols are used for waypoints that are near objects or restricted areas.

Never follow a route before checking each route leg is safe for your vessel.



Warning: Automatic route generation

- Do NOT rely on automatically generated routes to guarantee that the route is safe to navigate. You MUST review the suggested route carefully and where necessary edit the route before following it.
- If a waypoint within any automatically generated route is added or moved the Automatic route generation algorithm will NOT be used, extra care should be taken to ensure that the route leg and any moved waypoints are safe to navigate.

Caution: Easy Routing - Dredged areas

The C-MAP® Easy Routing feature will ignore some hazards in dredged areas. Easy Routing is intended for passage planning between harbors rather than within a harbor.



Warning: Traffic separation

Automatic route generation features do not adhere to the Traffic Separation Schemes identified in Rule 10 of the *International Regulations for Preventing Collisions at Sea 1972* as amended.

Raymarine® therefore recommends that you do NOT use Automatic route generation to create any part of a route which will cross traffic lanes or pass near to traffic separation lines. In these situations Automatic route generation MUST be switched Off and the route or route leg MUST be built manually, ensuring compliance to the rules laid out in the above regulations.



Warning: Minimum Safe Depth, Width and Height

Depending on cartography vendor, the *[Minimum safe depth]*, *[Minimum safe width]*, and *[Minimum safe height]* settings that you specify for your vessel will be used during automatic route generation. These settings will ensure that automatic routes are not generated in areas that are unsuitable for your vessel.

Minimum safe settings are user-defined calculations. As these calculations are outside of Raymarine's control, Raymarine will not be held liable for any damage, physical or otherwise, resulting from the use of the automatic route generation feature or the *[Minimum safe depth]*, *[Minimum safe width]* or *[Minimum safe height]* settings.

Autoroute - compatible cartography vendors

The Autoroute feature is compatible with the following cartography vendor features.

- Navionics® Autorouting.
- Navionics® Dock-to-dock
- C-MAP® Easy Routing

Differences between automatic route generation functions

There are important differences between the way different vendors handle automatic route generation.

Depth clearances (Tidal height)

- Navionics® Autorouting and Dock-to-dock avoids shallow areas based on the user defined *[Minimum safe depth]* setting plus an additional Navionics® safety margin. It assumes the lowest tide level, normally Lowest Astronomical Tide (LAT). The tide can be lower than LAT due to atmospheric effects such as high air pressure, wind direction, etc.
- C-MAP® Easy Routing assumes that there will be some tide. The user must apply their own safety margin as appropriate to current conditions. Route legs that cross areas shallower than the user defined *[Minimum safe depth]* setting are marked with hazard waypoint symbols, it is critical that these legs are checked to ensure that there is sufficient tide to avoid the hazard.

Width & Height clearances

- Navionics® Autorouting and Dock-to-dock does not use the user defined *[Minimum safe width]* or *[Minimum safe height]* settings when generating routes. Objects with width / height constraints are marked with hazard waypoint symbols, it is critical that these legs are checked to ensure that there is sufficient clearance to avoid the hazard.
- C-MAP® Easy Routing uses the user defined *[Minimum safe width]* and *[Minimum safe height]* settings to determine if sufficient clearance is available. The user must apply their own safety margin as appropriate to current conditions. The Height datum must be checked, as it could be Mean High Water Springs (MHWS) or Highest Astronomical Tide (HAT). In both cases the tide can be higher than the datum due to atmospheric effects such as high air pressure, wind direction, etc.

Reviewing an automatically generated route

Before following any route you must ensure that it is safe to do so.

Upon Route completion:

1. Range in on each route leg and waypoint that make up the Route.
2. Check either side of the route leg and around the waypoint for any possible obstructions.

Obstructions can be charted objects or restricted areas. Routes generated automatically should use the caution waypoint symbol in areas where there are possible obstructions.

3. Where obstructions exist move the necessary waypoints so that the waypoint and route leg is no longer obstructed.

Importing a route

You can import routes created in standard gpx format.

1. Save your route to a memory card.
2. Insert the memory card into your MFD.
3. Select Import from card from the Import/export page: *[Homescreen > My data > Import/export > Import from card]*.
4. Locate and select the gpx file that contains your Route.
The Route will be imported to your MFD.

Route management

Routes are managed using the Route list.

The Route list can be accessed from the Homescreen and from the Chart app:

- [Homescreen > My data > Routes]
- [Chart app > Menu > Waypoints, routes, tracks > Routes]

If the Route list is accessed from the Chart app menu, then the selected route is displayed in the live view pane on the right of the screen.

Route list

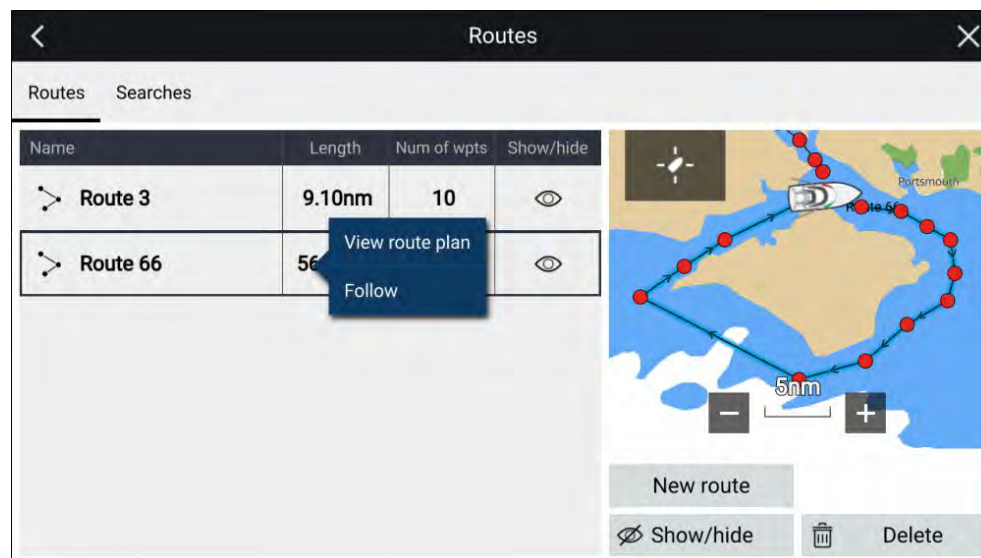

From the route list you can [Delete] routes, create a [New route] using existing waypoints or [Show/Hide] and existing route..

You can [Follow] a route or [View route plan] by selecting the relevant option from the Route pop-over menu.

Route plan

The route plan displays a list of all waypoints in the route and when accessed from the Chart app also includes a LiveView Chart pane showing the route's location.

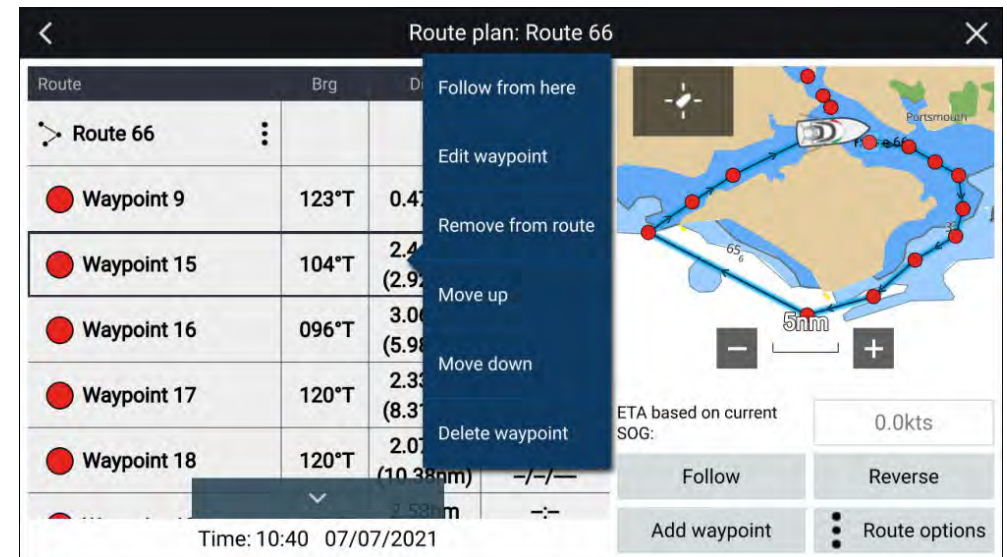

Selecting a waypoint from the list will open the pop-over menu . From the pop-over menu you can:

- [Follow from here]— Follow the route from the selected waypoint.
- [Edit waypoint]— edit the waypoints details.
- [Remove from route]— remove the waypoint from the route keeping the waypoint.
- [Move up]— move the waypoint up in the route list order.
- [Move down]— move the waypoint down in the route list order.
- [Delete waypoint]— delete the waypoint.

From the Route plan you can also :

- navigate the route by selecting [Follow].
- change the route direction by selecting [Reverse]. Selecting [Reverse] will overwrite the original route, swapping the start and end waypoints so that the route can be followed in the opposite direction. You can revert the route to its previous direction by selection [Reverse] again.
- add an existing waypoint to the route by selecting [Add waypoint].
- change route options by selecting [Route options].

Route options

Route options can be accessed from the route plan list.

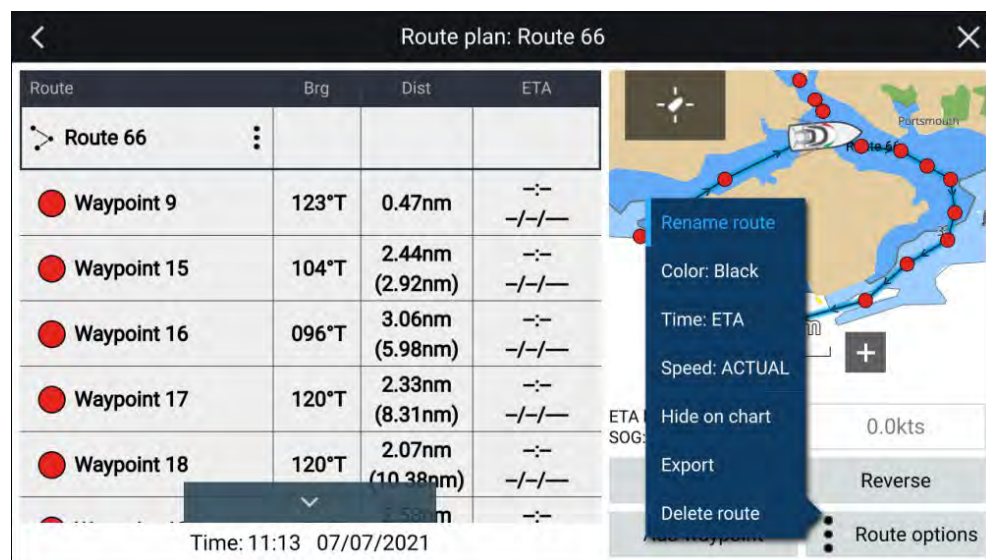

The following options are available:

- *[Rename route]*— rename the route.
- *[Color]*— change the color of the route.
- *[Time]*— switch between ETA (Estimated Time of Arrival) and TTG (Time To Go).
- *[Speed]*— switch between *[Actual]*(SOG) and *[Planned]*. When the speed is set to planned you can select a desired speed for navigating the route.
- *[Hide/show on chart]*— hide or show the selected route. When hidden the route will not be displayed in the Chart app but will still be accessible from the Route list.
- *[Export]*— export the route to a memory card.
- *[Delete route]*— delete the route.

11.3 Tracks

Tracks are used to record where you have been. Tracks are made up of track points that are created at regular time or distance intervals. You can store up to 15 tracks on your display, each track can contain up to 10,000 points.

When a track reaches 10,000 points it will be saved and if there is an unused track available a new track will be started automatically. If all tracks are used, then when the 15th track reaches 10,000 points track recording will stop and a notification will be displayed.

Tracks can be converted into routes so that they can be followed.

Creating a track

You can record your vessel's journey using Tracks.

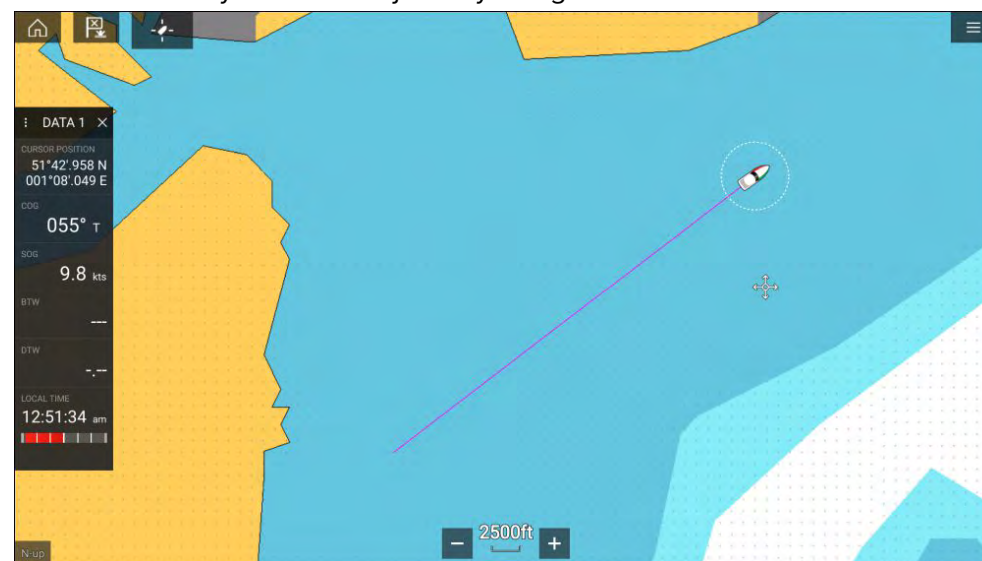

1. Select and hold on your vessel icon to display the vessel pop-over options.
2. Select *[Start track]*.
Your vessel's journey will now be recorded.
3. Select *[Stop track]* from the pop-over options when you have completed your track.
4. Select *[Save]* to save the track or *[Delete]* to remove the track.

You can also start a new track recording at anytime from the Chart menu: *[Menu > New > Start a new track]*. When using the Chart menu to start a track, if a track is already recording then it will be saved before the new track

is started. Once a Track is saved it can be converted to a Route so that the same passage may be followed again at a later date.

Converting a track to a route

From the Track list: *[Menu > Waypoints, routes, tracks > Tracks]*.

1. Select a track.
2. Select *[Create route from track]* from the pop-over options.
3. Select *[OK]*.

Track management

Tracks are managed using the Track list.

The Track list can be accessed from the Homescreen and from the Chart app: *[Homescreen > My data > Tracks]*, or *[Chart app > Menu > Waypoints, routes, tracks > Tracks]*.

If the Track list is accessed from the Chart app menu, then the selected track is displayed in a Chart pane on the right of the screen.

Track list



From the track list you can Start or Stop tracks recording, *[Delete]* a track or choose how tracks are recorded.

Track interval

The track interval determines the time period or distance between track points when recording a track. You can choose whether to record track points by Time, by Distance or set to Auto.

[Waypoints, Routes and Tracks](#)

- In *[Auto]* the track interval is set automatically to minimize the track points used whilst maintaining the actual path taken.
- When set to *[Time]*, you can choose a specified time period between track points.
- When set to *[Distance]* you can choose a specified distance between track points.

Customize tracks

From the Track pop-over options you can:

- rename a track
- change track color
- create a route from a track
- delete a track
- hide/show the track in the Chart app.

11.4 Sharing Waypoints, Routes and Tracks

Waypoints, Routes and Tracks can be shared with other devices

- MFDs connected over SeaTalkhs® (RayNet) network will automatically share waypoints, routes and tracks. When created on 1 MFD it is automatically duplicated on other MFDs in the network.
- Waypoints, routes and tracks can be shared with other non-networked MFDs and compatible devices by exporting them to a memory card and then importing on the desired device. For details refer to: [p.106 — Import/export](#)

Note:

- When your MFD is configured using the First responder Boat activity Waypoints and Routes can be imported and exported over an NMEA 0183 connection and Imported over an NMEA 2000 / SeaTalkng® connection. For details refer to: [p.378 — Import and export waypoints and routes over NMEA networks](#)
- Waypoints, Routes and Tracks cannot be shared over wireless connections.

11.5 Waypoint, routes and tracks capacity

Waypoints, routes and tracks are subject to capacity limits. The capacity limits for LightHouse™ 3 MFDs is shown below

- **Waypoints** — Your MFD can store up to 10,000 waypoints which can be sorted into up to 200 waypoint groups
- **Routes** — Your MFD can store up to 250 routes, each route consisting of up to 500 waypoints. The route capacity limit is subject to your MFD's 10,000 Waypoint limit (for example, your MFD could store 20 routes each containing 500 waypoints)
- **Tracks** — Your MFD can store up to 15 tracks, each track can contain up to 10,000 points.

CHAPTER 12: SAR (SEARCH AND RESCUE) PATTERNS

CHAPTER CONTENTS

- 12.1 SAR (Search and Rescue) patterns — page 168
- 12.2 Sector search pattern — page 168
- 12.3 Expanding square search pattern — page 171
- 12.4 Creeping line / Parallel line search pattern — page 173
- 12.5 Trackline search (return) pattern — page 175
- 12.6 Trackline search (non-return) pattern — page 176
- 12.7 Polygon search pattern — page 178
- 12.8 SAR pattern broadcast and receipt — page 179
- 12.9 Un-managed searches — page 180
- 12.10 Managed searches — page 182
- 12.11 Searches lists — page 188

12.1 SAR (Search and Rescue) patterns

Attempting to search the water for an object can be challenging, due to the vastness of the ocean and the effects of tide. Additionally, the object you are searching for is not normally in its last known location.

SAR Patterns are routes that can help you find an object in the water. Different types of SAR pattern are available and can take the effects of current/tide into account, enabling a more accurate and consistent route to search. SAR Patterns can be created on your MFD in the *[Chart app]*.

Important:

SAR patterns are broadcast at a 0.1 nm resolution. To ensure that SAR patterns appear the same on broadcaster and recipient MFDs, the *[Round patterns]* option should be enabled in the *[Responder Set up]* menu (*[Homescreen > Set-up > Responder Set-up]*). This will ensure that SAR patterns are rounded to the nearest 0.1 nm when they are created.

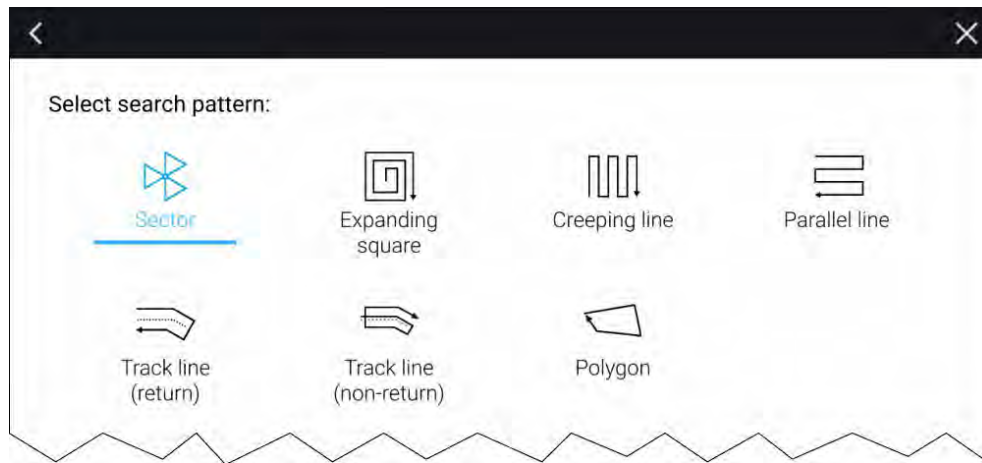

Search pattern options can be accessed from the Search patterns menu page: *[Chart app > Menu > New > Search patterns]*.

The available search pattern types are:

- *Sector Search*: [p.168](#) — [Sector search pattern](#)
- *Expanding square*: [p.171](#) — [Expanding square search pattern](#)
- *Creeping line*: [p.173](#) — [Creeping line / Parallel line search pattern](#)

- *Parallel Line*: [p.173](#) — [Creeping line / Parallel line search pattern](#)
- *Trackline (return)*: [p.175](#) — [Trackline search \(return\) pattern](#)
- *Trackline (non-return)*: [p.176](#) — [Trackline search \(non-return\) pattern](#)
- *Polygon*: [p.178](#) — [Polygon search pattern](#)

Once a search pattern is created it can be managed from the searches lists. For further information refer to: [12.11 Searches lists](#)

Important:

When they are created, SAR pattern names are automatically pre-fixed with 'SAR-'. If the 'SAR-' is removed or changed from the SAR pattern name it will no longer function as a SAR pattern (i.e.: it will not appear in the searches list or be able to be broadcast or followed as a SAR pattern). The renamed pattern will be treated as a normal route.

When the MFD is configured using the 'First responder' boating activity profile, SAR patterns can be broadcast and received over STEDS messaging. For more information refer to: [12.8 SAR pattern broadcast and receipt](#)

Note:

Before attempting to follow a search pattern ensure that you have set the waypoint arrival radius to the minimum value, otherwise the route navigated will not follow the search pattern.

12.2 Sector search pattern

The sector search pattern is made up of 9 legs, with the 3rd, 6th and 9th leg running past the datum. Track spacing will change depending on whether you are with or against the drift.

Note:

As the search pattern takes drift into account, the resulting search route may not resemble the pattern shown.

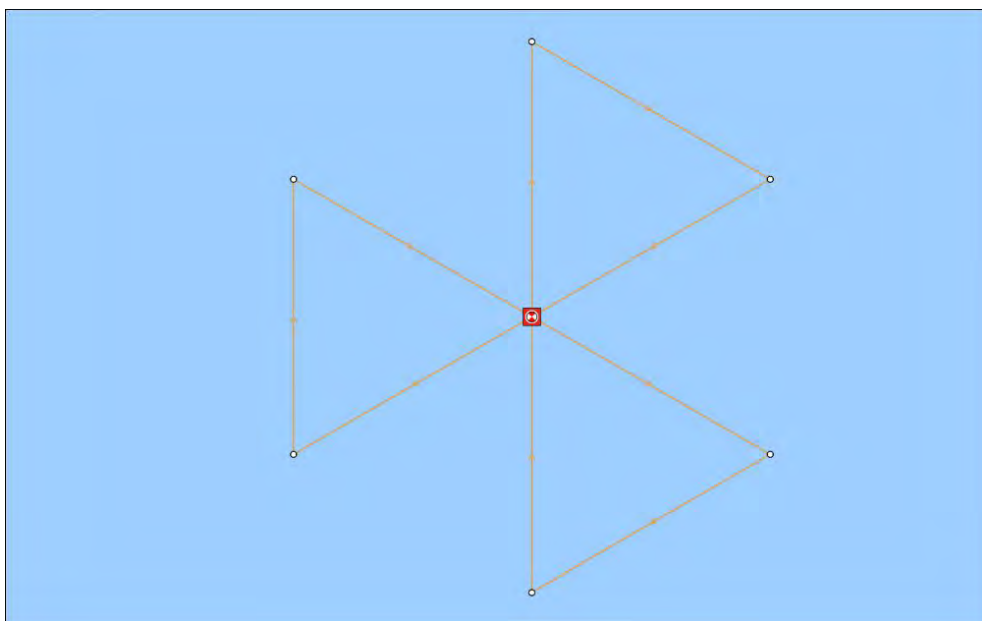

Creating a sector search pattern

To create a sector search pattern follow the steps below:

1. Open the Char app.

SAR (Search And Rescue) patterns

2. Select *[Sector]* from the *[Search Pattern]* options: *[Menu > New > Search pattern]*

3. Set the location of the Commence Search Point (CSP) for the search route by:

- i. Manually by selecting the *[Commence Search Point (CSP)]* field and inputting the coordinates for the CSP; the *[Range]* and *[Bearing]* of the CSP from your vessel's location is displayed.

By default and after a power cycle the coordinates shall be set to your vessel's current location, or if you have already created a search pattern then the last used Commence Search Point (CSP) position is displayed.

- ii. Alternatively, set the *[CSP]* at your vessel's current location by selecting the *[Location]* icon located to the right of the range and bearing details.

4. Establish set and drift by:

- i. Drop your Tide marker in the water and select *[Marker dropped]*.
- ii. Wait for the Tide marker to drift through the water.
- iii. Relocate to the Tide marker at its new location and select *[Drifted position]* the *[Set (Direction)]* and *[Drift (Speed)]* will be calculated and displayed.

- iv. Alternatively, you can use your vessel's Heading and SOG to define the set and drift by selecting the *[Set / Drift]* icon located to the right of the set and drift data.

5. Set the *[Track spacing/Radius]*, *[Search speed]* and *[Leg time]*.

The three variables are dependent on each other. One variable is always the product of the other two

- i. Select one of the variables by selecting the radio button (circle) located to the right of the variable.
- ii. The selected variable will be disabled and will be calculated automatically by setting the remaining 2 variables.

6. Select *[Create search route]*.

The Search created page is displayed shown the details of the created search route.

Leg	Course	Time
1	317°T	6m 0s
2	077°T	6m 0s
3	Datum	6m 0s
4	197°T	6m 0s
5	317°T	6m 0s
6	Datum	6m 0s
7	077°T	6m 0s
8	197°T	6m 0s
9	Datum	6m 0s

CSP:
Search length: 5.40nm

28°13.366' N 080°26.872' W

Follow route Broadcast

Back OK

The search route can be immediately followed by selecting *[Follow route]*, or broadcast over STEDs messaging by selecting *[Broadcast]*.

For details on broadcasting SAR patterns refer to:
[p.169 – SAR pattern broadcast and receipt](#)

Drift effects on sector search patterns

Set and drift are taken into account when creating sector search patterns. Some examples are shown below of what impact set and drift can have on the resulting SAR pattern.

Example sector search patterns

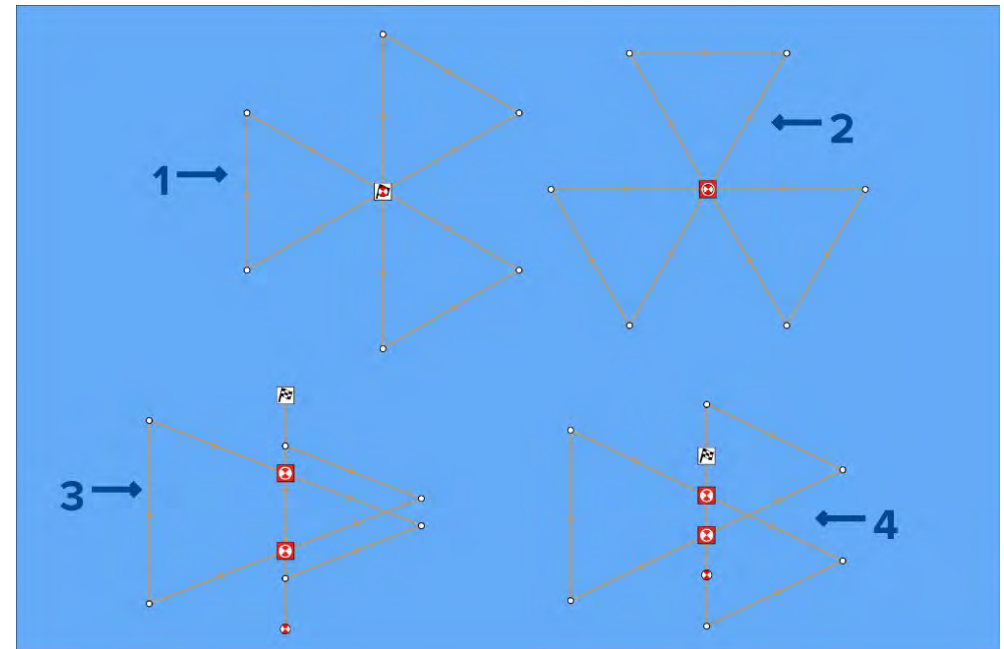

1. Set (Direction): 0°, Drift (Speed): 0 Kts.
2. Set (Direction): 90°, Drift (Speed): 0 Kts.
3. Set (Direction): 0°, Drift (Speed): 0.5 Kts.
4. Set (Direction): 0°, Drift (Speed): 1.0 Kts.

12.3 Expanding square search pattern

The Expanding Square search pattern is an outwards spiralling square pattern, and is particularly suited to very detailed and methodical searches.

Note:

The Search patterns take drift into account, and therefore the resulting route may not resemble the patterns shown.

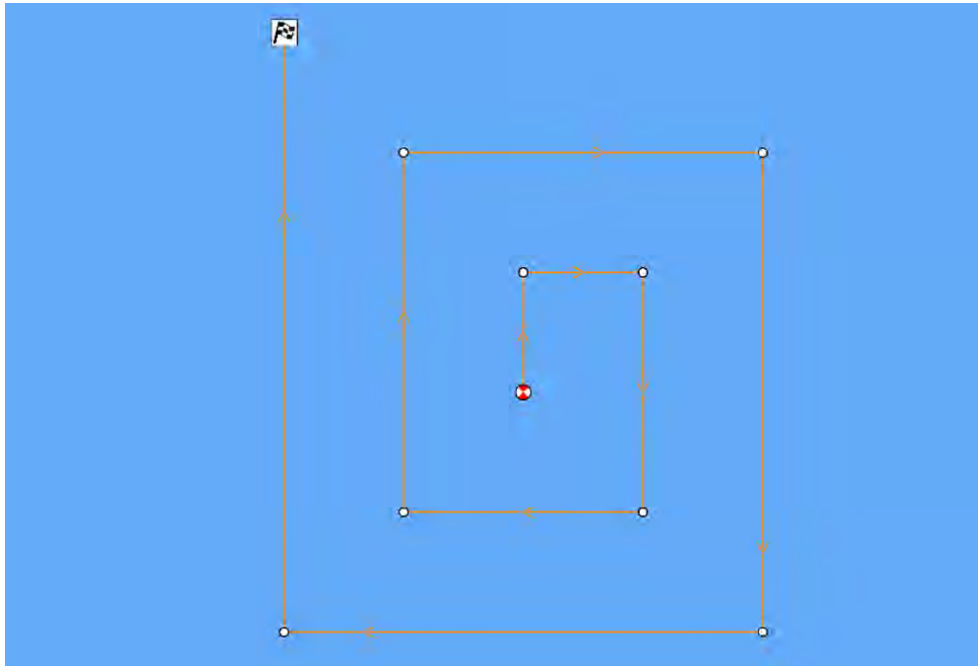

Creating an expanding square search pattern

To create an Expanding Square search pattern follow the steps below:

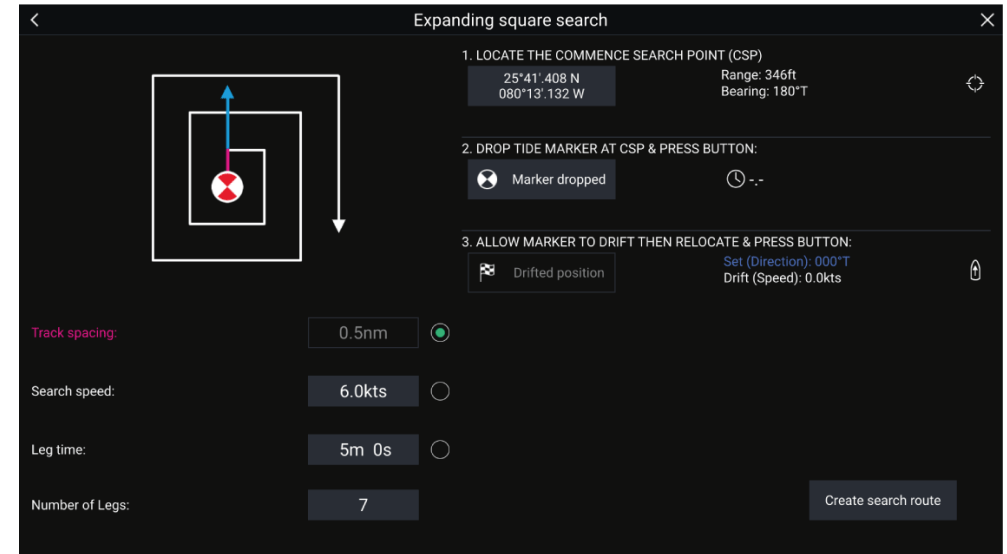

1. Select *[Expanding Square]* from the *[Search Pattern]* options: *[Chart app > Menu > Navigate > Search patterns]*
2. **Set Commence Search Point (CSP)**
 - i. Manually input the *[CSP]* coordinates; a *[Range]* and *[Bearing]* are displayed to direct your vessel towards it.
 - ii. Alternatively, set the *[CSP]* as your vessel's current location by selecting the ⁽¹⁾ *[CSP Shortcut]* button.
3. **Set Drift**
 - i. Drop the *[Datum Marker]* in the water and select *[Marker dropped]*.
 - ii. Wait for the *[Datum Marker]* to drift through the water.
 - iii. Return to the *[Datum Marker]* in the new location and select *[Drift position]* to calculate the *[Set (Direction)]* and *[Drift (Speed)]*.
 - iv. Alternatively, you can use your vessel's *[Heading]* and *[SOG]* to define the set and drift by selecting the ⁽²⁾ *[Set / Drift shortcut]* icon.
4. **Set Track spacing / Radius, Search Speed, and Leg time**

[All 3 variables are dependent on each other. One variable is always the product of the other two.]

- i. Select one of the variables by selecting the ⁽³⁾ *[Output]* icon.

- ii. The selected variable will then be calculated as a result of changes made to the other two variables.

Variable	Maximum Value
Track spacing / Radius	5 nm / 5 sm / 5 Km
Search Speed	40 Kts / 46 Mph / 74 Kph
Leg Time	59m 59s

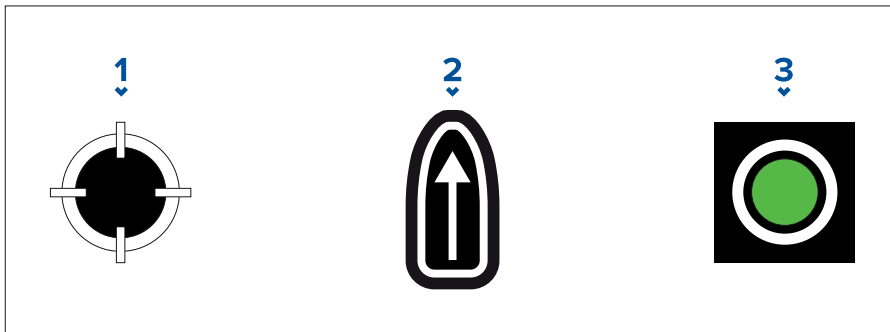

1. [CSP Shortcut]
2. [Set / Drift Shortcut]
3. [Output]

5. Set the number of legs

- i. Select the number of legs for your expanding square search pattern.

6. Create search route

[After all the above steps have been completed you can create your SAR pattern.]

- i. To create a search pattern, select [Create search route] in the bottom right of the screen.
- ii. The creation page will display your SAR pattern data and its location in the Chart app.

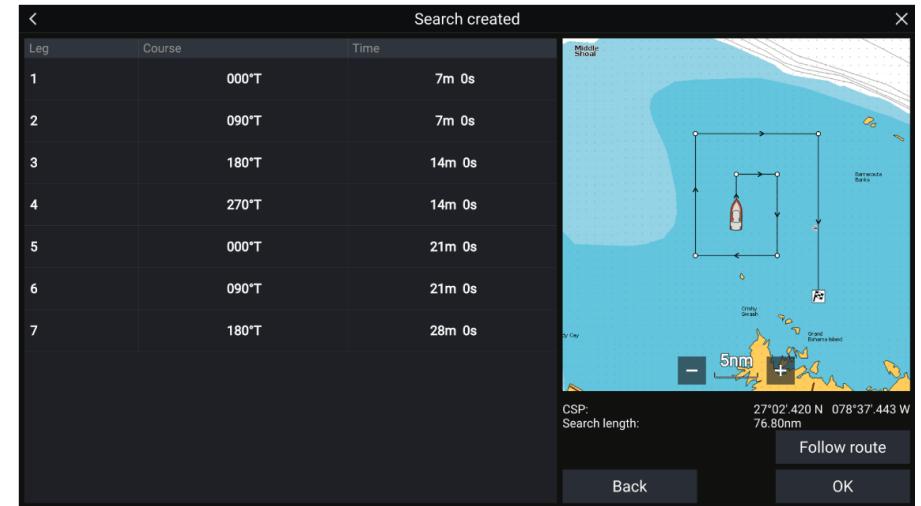

- iii. Select [Follow Route] to overlay the pattern on the Chart app and automatically follow the route.
- iv. Alternatively, select [OK] to overlay the pattern on the Chart app without following it.

Drift effects on expanding square search patterns

As the search patterns account for tidal drift the resulting Route may not resemble the pattern shown above.

Example expanding square search patterns

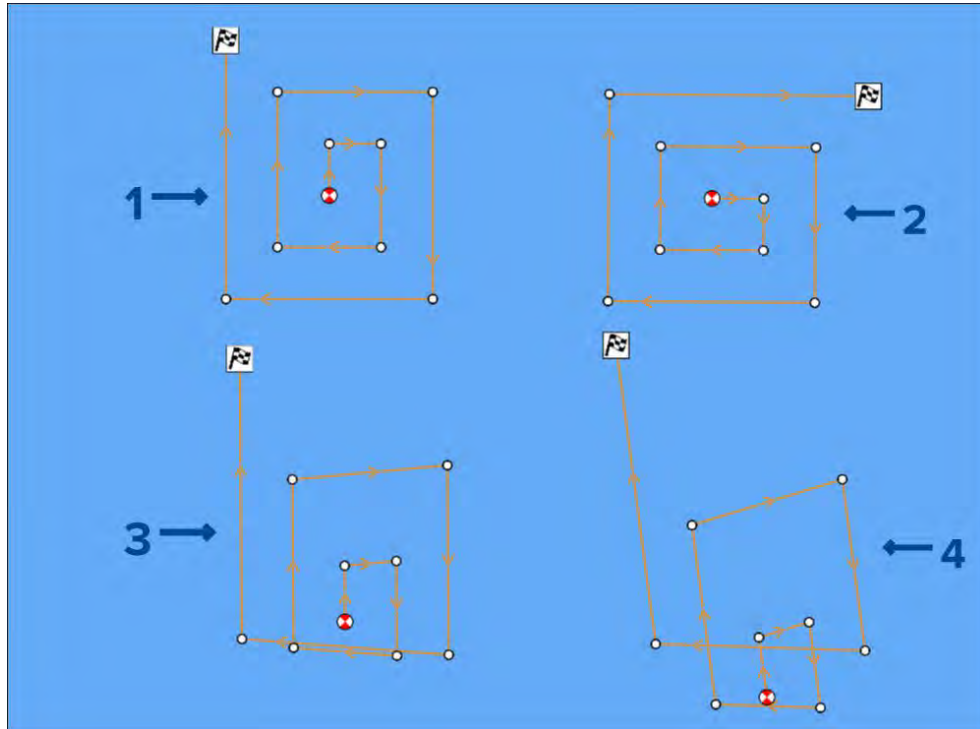

1. Set (Direction): 0°, Drift (Speed): 0 Kts.
2. Set (Direction): 90°, Drift (Speed): 0 Kts.
3. Set (Direction): 0°, Drift (Speed): 0.5 Kts.
4. Set (Direction): 0°, Drift (Speed): 1.0 Kts.

12.4 Creeping line / Parallel line search pattern

The [Creeping line search pattern] and [Parallel line search pattern] both cover a rectangular area. A creeping line search pattern provides greater coverage of the area but takes time to cover the whole area. A parallel line search pattern can cover the same area more quickly whilst still providing reasonable coverage.

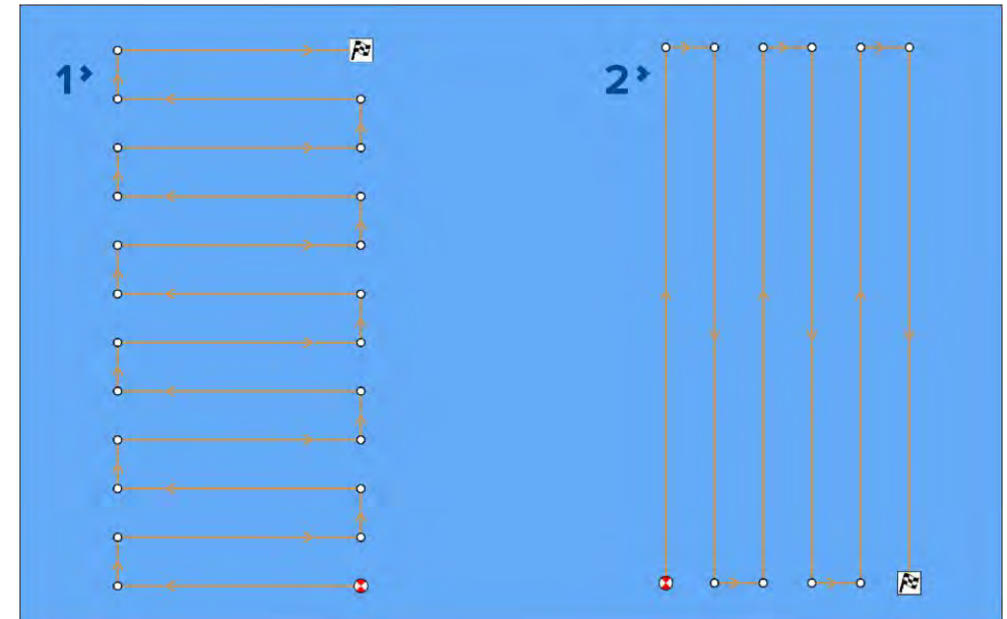

1. Creeping line search pattern
2. Parallel line search pattern

Creating a Creeping line / Parallel line search pattern

To create a Creeping line / Parallel line search pattern follow the steps below:

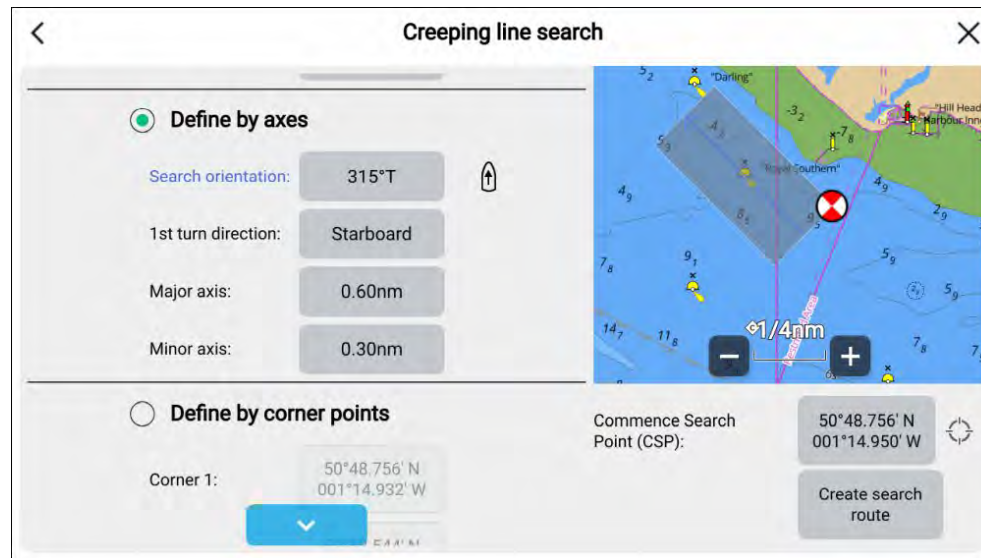

1. Select either *[Creeping line]* or *[Parallel line]* from the *[Search Pattern]* options: *[Chart app > Menu > New > Search pattern]*.
2. Set the *[Commence Search Point (CSP)]* by either:
 - i. Selecting the *[Commence Search Point (CSP)]* coordinates field to enter new coordinates, or,
 - ii. Selecting the *[CSP]* icon located to the right of the coordinates to set your vessel's current location as the CSP.
3. Select the *[Search speed]* field to set the speed at which the search should be performed.
4. Select the *[Track spacing]* field to set the distance between each search leg.
5. Define the search rectangle using axes *[Define by axes]*:
 - i. Select *[Define by axes]*.
 - ii. Select the *[Search orientation]*/*[1st leg direction]* field to set the orientation for the search pattern, or select the *[Direction icon]* located to the right of the *[Search orientation]*/*[1st leg direction]* field to set your vessel's current heading as the orientation/direction for the search pattern.
 - iii. Select the *[1st turn direction]* field to set whether the first turn will be to *[Port]* or *[Starboard]*.

- iv. Select the *[Major axis]* field to set the length of the major axis search legs.
- v. Select the *[Minor axis]* field to set the length of the minor axis search legs.

Variable	Maximum Value
Track spacing / radius	5 NM / 5 sm / 5 km
Search speed	40 Kts / 46 MPH / 74 KPH
Major axis/Minor axis	20 NM / 23 sm / 37 km

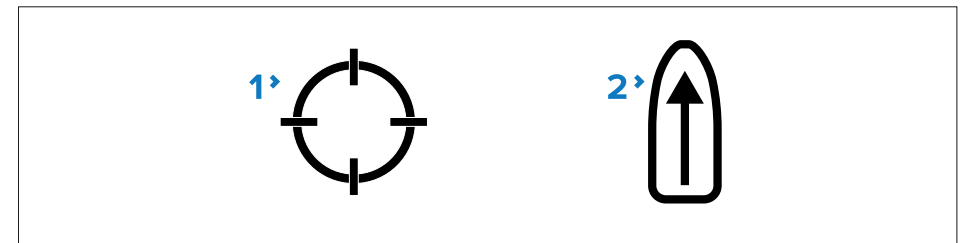

1. *[CSP icon]*

2. *[Direction icon]*

Or, If you would prefer not to define the search rectangle dimensions using the major and minor axis, the rectangle can be defined by setting the coordinates of each corner point instead:

6. Define the search rectangle using coordinates *[Define by corner points]*
 - i. Select *[Define by corner points]*.
 - ii. Enter coordinates for *[Corner 1]*, *[Corner 2]*, *[Corner 3]* and *[Corner 4]*.

Note:

- The corner coordinates need to form a rectangle. If the coordinates are not suitable then you will not be able to create the search route.
- The CSP must be on one of the sides of the search pattern.
- For a Creeping Line search pattern the CSP must be located along one of the longer sides.
- For a Parallel Line search pattern the CSP must be located along one of the shorter sides.
- The CSP must be on a bearing of between 85° to 95° (i.e. right angle $\pm 5^\circ$) from the previous side.
- The CSP should be half a track width from the corner point.

12.5 Trackline search (return) pattern

The *[Trackline search (return)]* pattern, also referred to as 'Trackline Single-unit Return (TSR)', is used when the only available information is the intended route of a vessel or aircraft. This type of search pattern is often used as an initial search effort due to speed that it can be planned and implemented.

The *[Trackline search (return)]* pattern usually consists of 2 search legs, one on either side of the intended route. The search pattern will follow the intended route to one side and then return on the other side. The search legs will be parallel and be a specified distance (track spacing) apart, with the intended route in the center (i.e.: The intended route will be separated from the search legs by half the specified Track distance).

Example trackline search (return) pattern

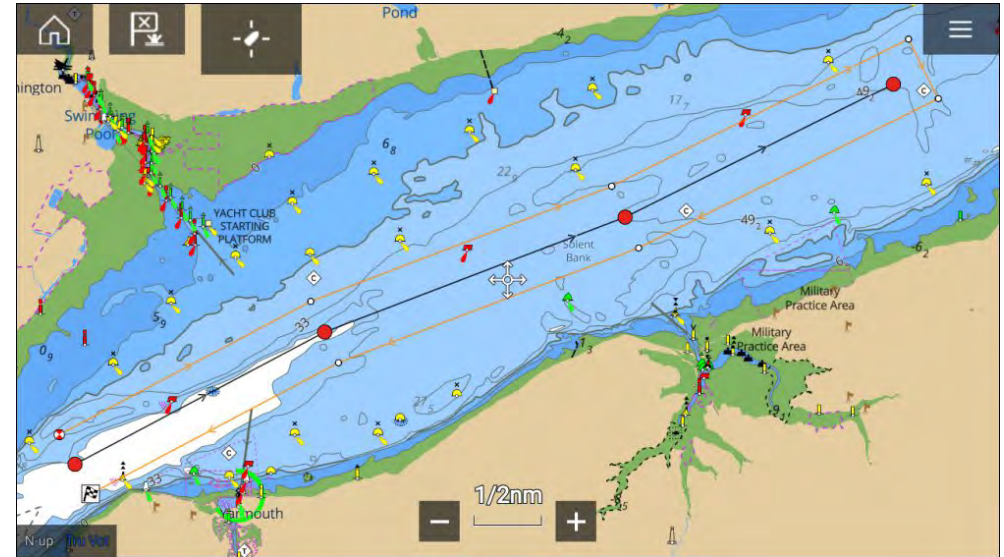

The search pattern can also be configured to traverse the route more than twice, enabling a greater area to be searched on either side of the intended route.

Traversals are done in pairs so that the final search leg returns to the same end of the intended route that the search commenced. All search legs use the same track spacing.

Traversal examples



1. Intended route
2. 2 traversals (once per side)
3. 6 traversals (three times per side)

Creating a trackline search (return) pattern

Trackline search (return) patterns can be created from existing routes or by creating a route using waypoints. To create a trackline search (return) pattern follow the steps below:

1. Select *[New]* from the Chart app menu.
2. Select *[Search pattern]*.
3. Select *[Trackline search (return)]*.

The search pattern creation page is displayed.

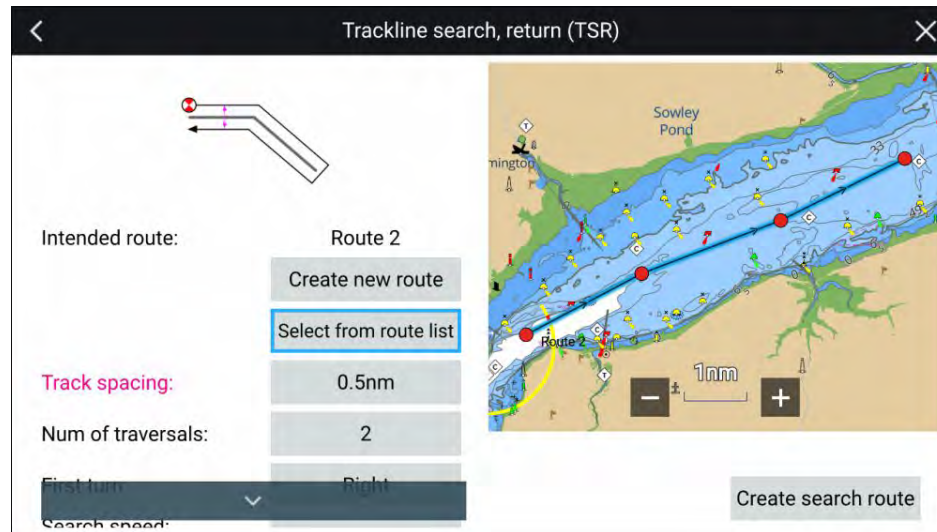

4. Select *[Select from route list]*.
5. Select the desired route from the route list.

You can also select [Create new route] to create a new empty route that you can then add waypoints to.

6. Select *[Select route]* from the pop-over menu.

You will be taken back to the search pattern creation page.

7. Select *[Track spacing:]* to adjust the distance between each search leg.
8. Select *[Num of traversals:]* and select the number of times you want the search pattern to traverse the intended route.

The available options are 2, 4, 6, and 8.

9. Select *[First turn:]* to choose whether you want the first turn of the trackline to go to the right or the left.

This will also therefore determine the side of the route which the Commence Search Point will be placed.

10. Select *[Search speed (STW):]* to enter the desired speed at which the search should be performed.

Search speed is Speed Through the Water (STW).

11. Select *[Create search route]*.
12. Select *[OK]* to save the search pattern, or *[Follow]* to save the search pattern and immediately start following the route.

Selecting [Back] will return you to the search pattern creation page without saving the search pattern.

The search pattern will be displayed using orange lines for the search legs. The search pattern will be available in the Searches list: *[Menu > Waypoints, Routes, tracks > Routes > Searches]*.

12.6 Trackline search (non-return) pattern

The *[Trackline search (non-return)]* pattern, also referred to as 'Trackline Single-unit Non return (TSN)', is used when the only available information is the intended route of the vessel or aircraft. This type of search pattern is often used as an initial search effort due to speed that it can be planned and implemented.

The *[Trackline search (Non-return)]* pattern is a search pattern that follows an intended route from start to finish.

Example trackline search (non-return) pattern

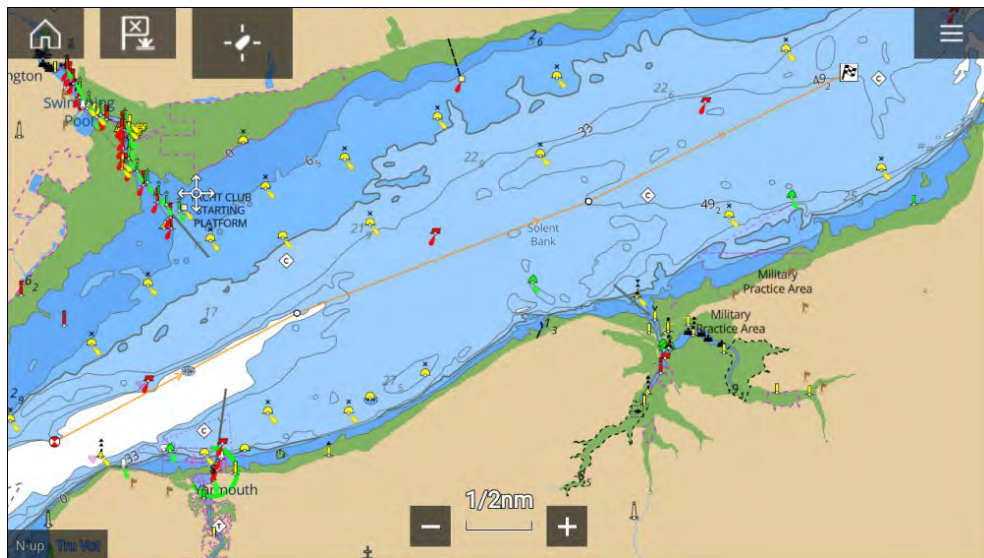

The search pattern can be configured to traverse the route more than once, enabling a greater area to be searched on either side of the intended route.

When multiple traversals are required, the search pattern will return to the end of the route that the search commenced and then follow it to the end again. These subsequent search legs will be parallel and be a specified distance (track spacing) from the first traversal and the intended route.

After the first traversal subsequent traversals are done in pairs so that the final search leg finishes at the end of the intended route.



1. Intended route
2. 1 traversal (follows intended route)
3. 5 traversals (intended route plus 2 per side)

SAR (Search And Rescue) patterns

Creating a trackline search (non-return) pattern

Trackline search (non-return) patterns can be created from existing routes or by creating a route using waypoints. To create a trackline search (non-return) pattern follow the steps below:

1. Select *[New]* from the Chart app menu.
2. Select *[Search pattern]*.
3. Select *[Trackline search (non-return)]*.

The search pattern creation page is displayed.

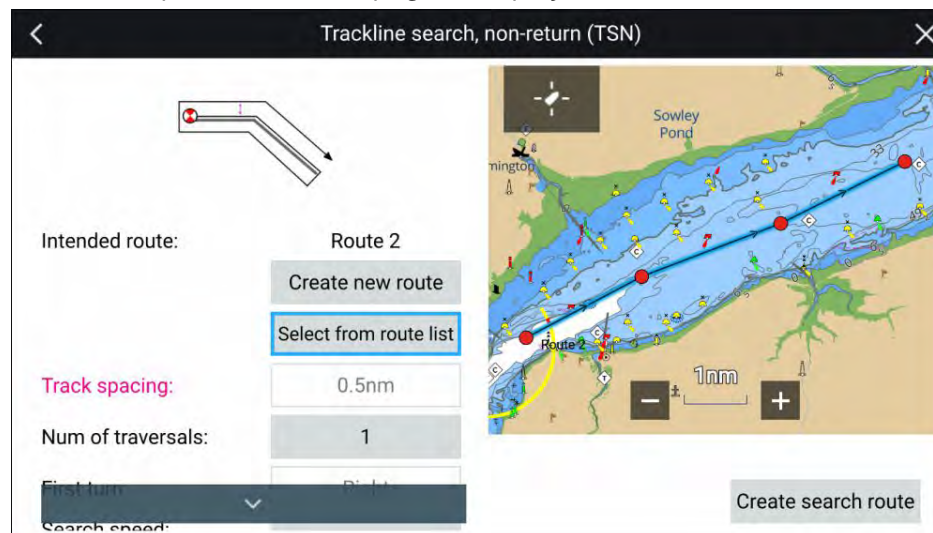

4. Select *[Select from route list]*.
5. Select the desired route from the route list.

You can also select [Create new route] to create a new empty route that you can then add waypoints to.

6. Select *[Select route]* from the pop-over menu.

You will be taken back to the search pattern creation page.

7. Select *[Track spacing:]* to adjust the distance between each search leg.
No track spacing is required for 1 traversal.

8. Select *[Num of traversals:]* and select the number of times you want the search pattern to traverse the intended route.

The available options are 1, 3, 5, and 7.

9. Select *[First turn:]* to choose whether you want the first turn of the trackline to go to the right or the left.

No turn is required for 1 traversal.

10. Select *[Search speed (STW):]* to enter the desired speed at which the search should be performed.

Search speed is Speed Through the Water (STW).

11. Select *[Create search route]*.
12. Select *[OK]* to save the search pattern, or *[Follow]* to save the search pattern and immediately start following the route.

Selecting [Back] will return you to the search pattern creation page without saving the search pattern.

Note:

The intended route that was used to create the search pattern will be hidden so that only the search pattern's search legs and waypoints are shown onscreen.

12.7 Polygon search pattern

The *[Polygon search]* pattern can be used to try and locate a target as it is drifting in a strong current. The search pattern should be created perpendicular to the direction of drift and is used to search back and forth 'down current' of a search area. This search pattern can also be used in any search situation that requires the search to follow a specified route and end the search back at the commence search point (CSP).

The Polygon search pattern is created from an existing route and connects the first and last waypoints in a route to create a polygon shape.

Example polygon search pattern

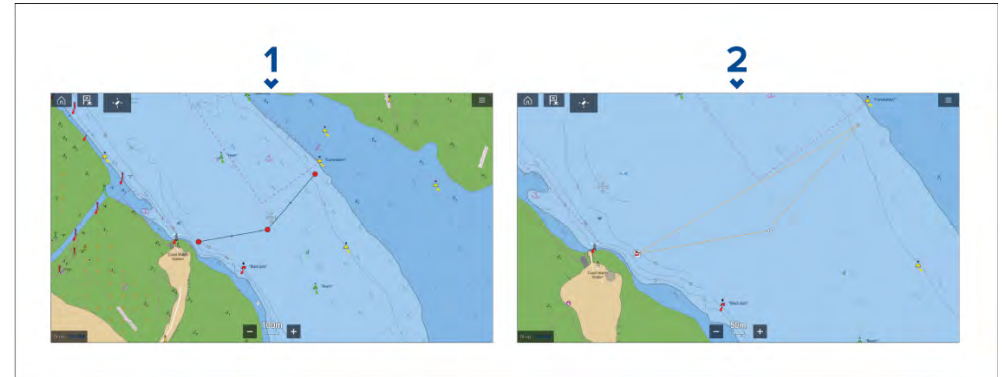

1. Existing route
2. Polygon search pattern.

Creating a polygon search pattern

Polygon search patterns can be created from existing routes or by creating a route using waypoints. To create a polygon search pattern follow the steps below:

1. Select *[New]* from the Chart app menu.
2. Select *[Search pattern]*.
3. Select *[Polygon]*.

The search pattern creation page is displayed.

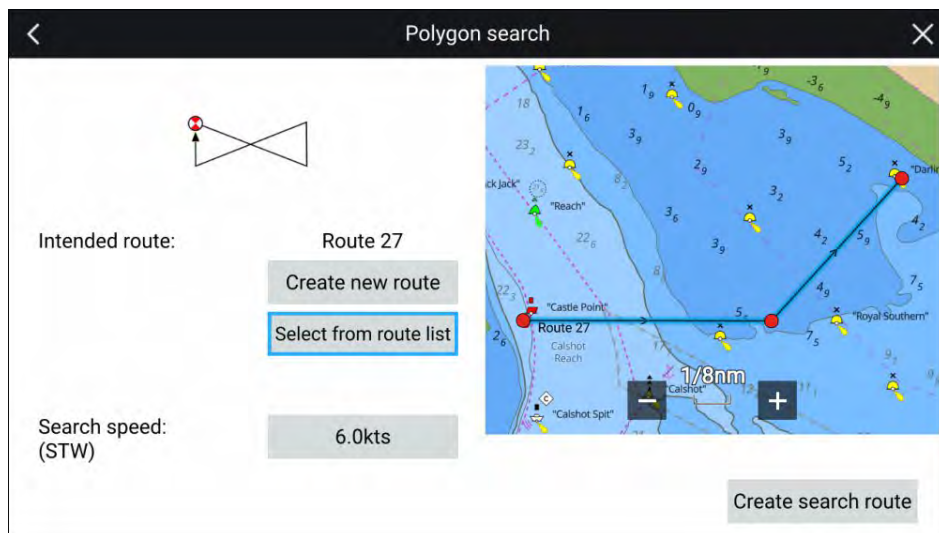

4. Select *[Select from route list]*.
5. Select the desired route from the route list.
You can also select [Create new route] to create a new empty route that you can then add waypoints to.
6. Select *[Select route]* from the pop-over menu.
You will be taken back to the search pattern creation page.
7. Select *[Search speed (STW):]* to enter the desired speed at which the search should be performed.
Search speed is Speed Through the Water (STW).
8. Select *[Create search route]*.
9. Select *[OK]* to save the search pattern, or *[Follow]* to save the search pattern and immediately start following the route.
Selecting [Back] will return you to the search pattern creation page without saving the search pattern.

The search pattern will be displayed using orange lines for the search legs. The search pattern will be available in the Searches list: *[Menu > Waypoints, Routes, tracks > Routes > Searches]*.

12.8 SAR pattern broadcast and receipt

SAR patterns can be broadcast and received using STEDs messaging. SAR patterns can be either managed or un-managed.

Important:

SAR patterns are broadcast at a 0.1 nm resolution. To ensure that SAR patterns appear the same on broadcaster and recipient MFDs, the *[Round patterns to nearest 0.1 nm]* option should be enabled in the *[Advanced set up]* menu (*[Homescreen > Settings > Responder > Advanced set up]*) before the SAR pattern is created. This will ensure that SAR patterns are rounded to the nearest 0.1 nm when they are created.

Un-managed

- When an un-managed SAR pattern is broadcast, it will be received by all responder vessels that are using the same STEDs passphrase.
- When an un-managed SAR pattern is received, it can be imported and followed. Progress updates for un-managed searches will need to be manually reported using STEDs messaging.

Managed

- When a managed SAR pattern is broadcast, it will be received by all responder vessels that are using the same STEDs passphrase. The broadcaster will assign themselves as Search Mission Coordinator (SMC) and assign a specific vessel as the Search and Rescue Unit (SRU). The SMC will receive automatic progress updates from the SRU.
- When a managed SAR pattern is received, the SRU must accept the SAR pattern to import and initiate the managed search. The SRU will send automatic progress updates to the SMC. Non-SRU recipients will receive the SAR pattern and can import it for awareness and monitoring purposes.

The SMC will automatically receive progress updates from the SRU when the SAR pattern is:

- Accepted
- Rejected
- Started (CSP reached)
- Diverted from (started diversion away from SAR pattern)

- Resuming (ended divert and travelling back to SAR pattern).
- Resumed (reached point to resume the SAR pattern)
- Completed
- Aborted.

Hiding original SAR pattern

When a SAR pattern is broadcast it is duplicated and duplicate is pattern that is broadcast. To avoid any confusion you can hide the original SAR pattern.

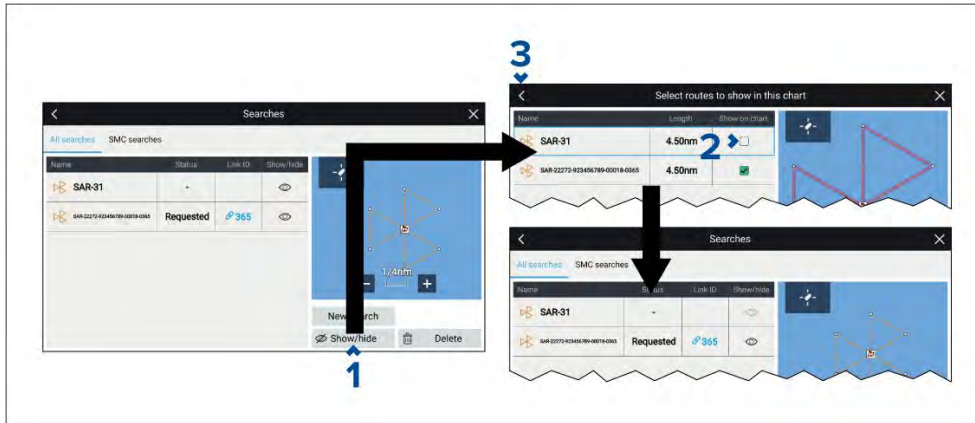

From the *[All searches]* list:

1. Select *[Show/Hide]*.
2. Remove the tick from the original SAR pattern.

The original SAR pattern will have a shorter name (e.g.: SAR-31), the broadcast SAR pattern will have a longer name (e.g.: SAR-22272-923456789-00018-0365).

3. Select *[<]* (Back arrow), or *[X]* (Close) to return to the *[All searches]* list.

12.9 Un-managed searches

Broadcasting an un-managed SAR pattern

To broadcast a SAR pattern where no SMC and SRU is assigned, follow the steps below:

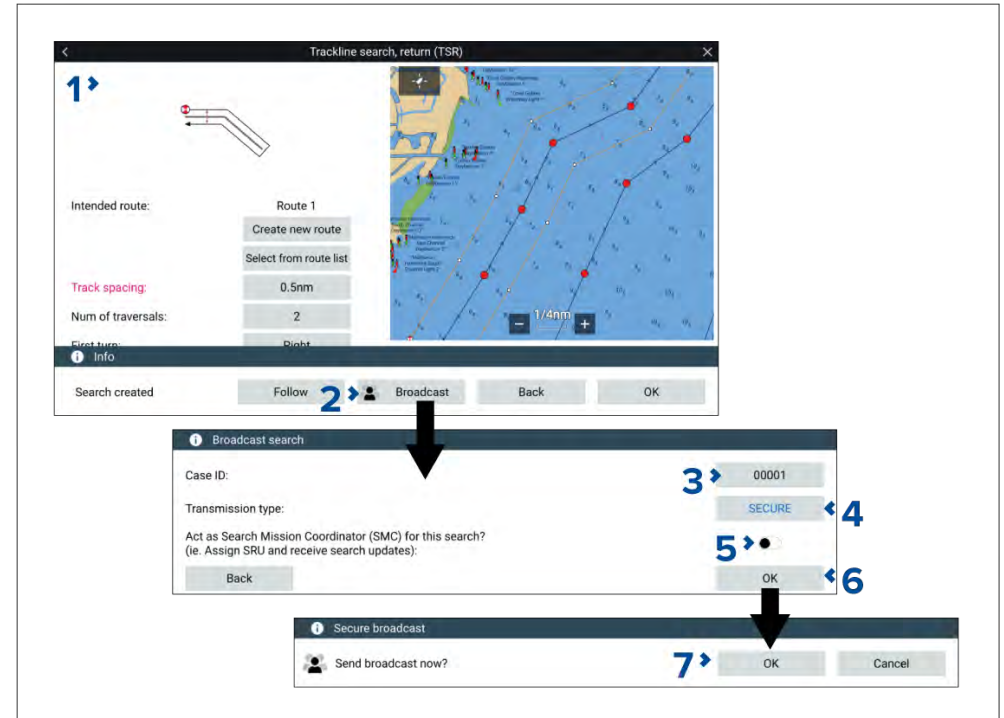

1. Create a SAR pattern. For details refer to: [p.168 – SAR \(Search and Rescue\) patterns](#)
2. After selecting *[Create search route]*, select *[Broadcast]*.
3. If required, change the *[Case ID]*.

The case ID will automatically increment, however it can also be assigned manually by selecting the case ID field.

4. If required, change the *[Transmission type]*.

*Depending on AIS mode, SAR patterns can be broadcast as a *[Secure]* or *[Non-secure]* transmission:*

- *In AIS restricted mode only, secure SARs can be sent.*

- In AIS normal mode, you can choose whether to send as secure or non-secure.
- In AIS receive only mode, SAR patterns cannot be sent.

Secure broadcasts will only be received by vessels using the same STEDs passphrase. Non-Secure broadcasts can be received by all vessels with STEDs-compatible hardware.

5. Ensure *[SMC]*(Search Mission Coordinator) is disabled.
6. Select *[OK]*.
7. Select *[OK]*.

The SAR pattern is broadcast.

Existing SAR patterns can be broadcast from the searches list: *[Chart app > Menu > Waypoints, routes, track > Searches]*. Select the SAR pattern and choose *[Broadcast]* from the pop-over menu.

SAR pattern receipt (un-managed / not assigned as SRU)

When you receive an un-managed SAR pattern, or a managed SAR pattern where you are not the assigned SRU, the SAR pattern can be imported and, if required, followed.

When a SAR pattern is received, a notification is displayed onscreen.

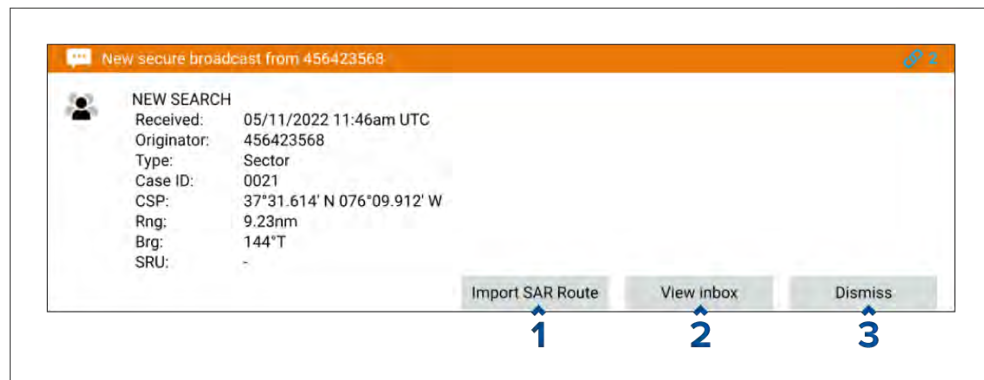

The notification provides details about the SAR pattern and the following options:

1. *[Import SAR Route]*— Imports the SAR pattern so that it can be displayed in the chart app.

[SAR \(Search And Rescue\) patterns](#)

2. *[View inbox]*— Closes the notification and opens the messages inbox so that you can view the related message. The search can be imported by using the inbox message options.
3. *[Dismiss]*— Selecting dismiss will close the notification. The search can be imported by using the inbox message options.



Once a SAR pattern is imported, it can be followed by selecting *[Follow route]* or, if the chart app is open, it can be viewed onscreen by selecting *[Show on chart]*. If you select *[Dismiss]* the SAR pattern can be followed at a later time from the searches lists.

For more information about SAR patterns, refer to:

[p.167 — SAR \(Search And Rescue\) patterns](#)

Note:

When performing a search on an un-managed SAR pattern, the broadcaster will not receive automatic progress updates in the same way as for a managed search, therefore you may be required to provide regular manual updates using STEDs messaging.

Search pattern waypoint arrival alarm

When following a search pattern the waypoint arrival alarm will be triggered when entering the specified arrival radius and also when passing perpendicular to the waypoint.

The *[Search route arrival radius]* setting determines the radius/distance from the waypoint that the waypoint arrival alarm is triggered. The *[Search route arrival radius]* can be checked and adjusted from the *[Alarms]* menu: *[Homescreen > Alarms > Settings > Search route arrival radius]*.

The waypoint arrival alarm can be configured to only trigger when the arrival radius is reached and not when passing perpendicular by selecting *[Radius only]* from the bottom of the *[Advanced]* Chart app settings menu: *[Menu > Settings > Advanced > Waypoint arrival (Search routes)]*.

12.10 Managed searches

SMC action — Broadcasting a SAR pattern

SAR patterns can be broadcast over STEDs messaging when they are created. Follow the steps below to broadcast a new SAR pattern.



1. Create a SAR pattern. For details refer to: [p.168 — SAR \(Search and Rescue\) patterns](#)
2. After selecting *[Create search route]*, select *[Broadcast]*.
3. If required, change the *[Case ID]*.

The case ID will automatically increment, however it can also be assigned manually by selecting the case ID field.

4. If required, change the *[Transmission type]*.

*Depending on AIS mode, SAR patterns can be broadcast as a *[Secure]* or *[Non-secure]* transmission:*

- *In AIS restricted mode, only secure SARs can be sent.*
- *In AIS normal mode, you can choose whether to send as secure or non-secure.*
- *In AIS receive only mode, SAR patterns cannot be sent.*

Secure broadcasts will only be received by vessels using the same STEDs passphrase. Non-Secure broadcasts can be received by all vessels with STEDs-compatible hardware.

5. Ensure *[SMC]* (Search Mission Coordinator) is enabled.
6. Select *[OK]*.
7. Select a contact from the *[Local]*, *[Recent]* or *[Buddies]* list, or select *[Enter MMSI]* to enter an MMSI manually for the vessel you want to assign as the SRU.
8. Select *[Next]*.
9. Select *[OK]*.

The SAR pattern is broadcast.

Existing SAR patterns can be broadcast from the searches list: *[Chart app > Menu > Waypoints, routes, track > Searches]*. Select the SAR pattern and choose *[Broadcast]* from the pop-over menu.

SMC action — Instructing SRU to divert

An SMC can instruct an SRU to divert. The divert instruction provides the SRU with the location that they should divert to. Optionally the divert instructions can also include a point in the current search pattern that the SRU should perform the divert from. Once the SRU has initiated the divert the SMC can also instruct the SRU of the point in the search pattern that they should resume from once the divert is complete.

Important:

SAR patterns created with the **Round pattern** option disabled will be automatically rounded if they are broadcast. This means that the SMC SAR pattern may be different from the SAR pattern received by the SRU. In this situation SMC instructed divers may also appear in a different location. To prevent this occurrence, ensure that the **Round pattern** option is enabled on the SMC system before creating the SAR pattern.

Note:

When a SAR pattern is broadcast it is duplicated. To access the broadcasted SAR pattern's context menu options instead of the options for the original SAR pattern you may need to hide the original SAR pattern. For details refer to: [p.180 — Hiding original SAR pattern](#)

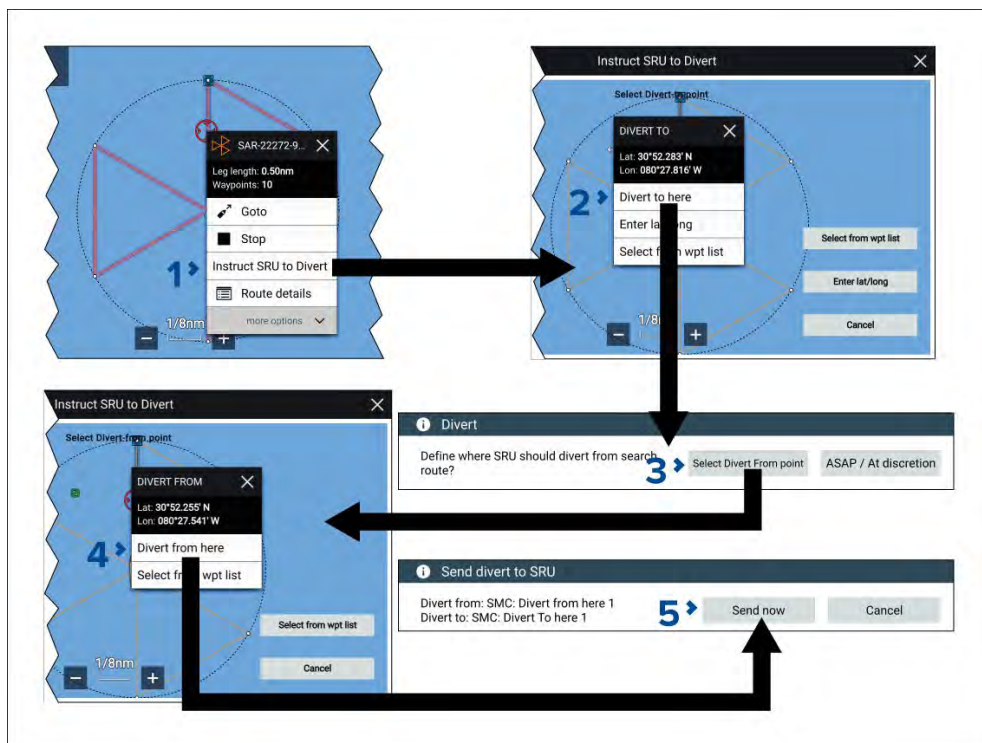

2. Select the divert location.
The divert location can be set by:
 - selecting a location onscreen and then selecting *[Divert to here]*,
 - selecting *[Select from wpt list]* and using a waypoint that has already been created.
 - selecting *[Enter lat/long]* and entering the coordinates for the divert location.
3. Choose where the SRU should divert from by selecting:
 - *[Select Divert From point]* — allows you to select a waypoint in the search pattern that the SRU should divert from when it is reached.
 - *[ASAP / At discretion]* — allows the SRU to decide when to perform the divert.
4. If *[Select Divert From point]* has been selected choose the point along the search pattern's route legs or a waypoint in the search pattern and then select *[Divert From here]* from the context menu.
5. Select *[Send now]*.

SMC action — Instructing SRU to resume

When an SMC has instructed an SRU to divert and the SRU has initiated the divert, the SMC can also instruct the SRU of a specific point where they should resume the search from.

Note:

When a SAR pattern is broadcast it is duplicated. To access the broadcasted SAR pattern's context menu options, instead of the options for the original SAR pattern, you may need to hide the original SAR pattern. For details refer to: [p.180 — Hiding original SAR pattern](#)

Note:

An SMC instructed divert can only be performed once the SRU has reached the CSP and has commenced the search.

1. Select the SAR pattern onscreen to open the context menu and then select *[Instruct SRU to Divert]* from the pop-over options.
[Instruct SRU to Divert] can also be selected from:
 - The BlueForce target icon's context menu.
 - The SMC searches list pop-over options (If the SMC searches list is accessed from the Homescreen rather than the Chart app menu you can only select a waypoint from the list or enter lat/long coordinates for the divert point).
 - The message's pop-over options from the messages inbox.

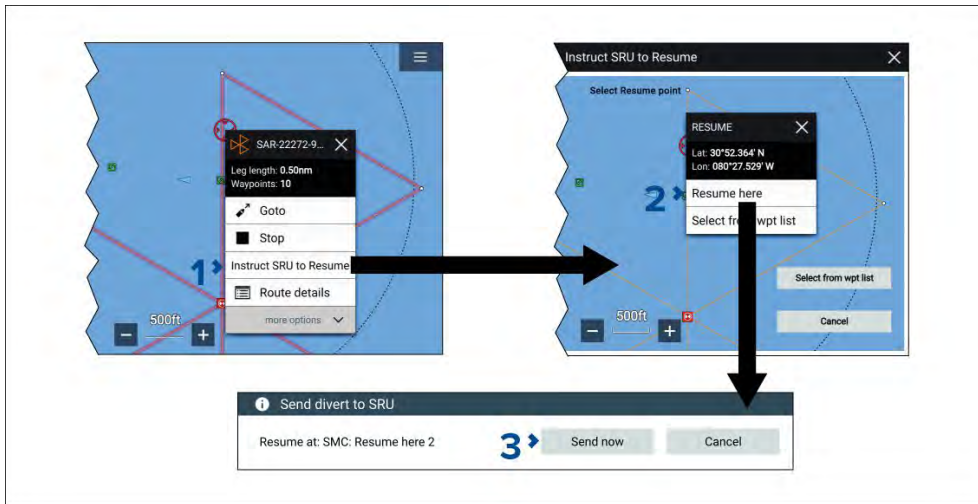

SRU SAR pattern receipt notification overview

When a SAR pattern is broadcast, that assigns your vessel as the SRU, a notification is displayed.

The following options are available from the notification:

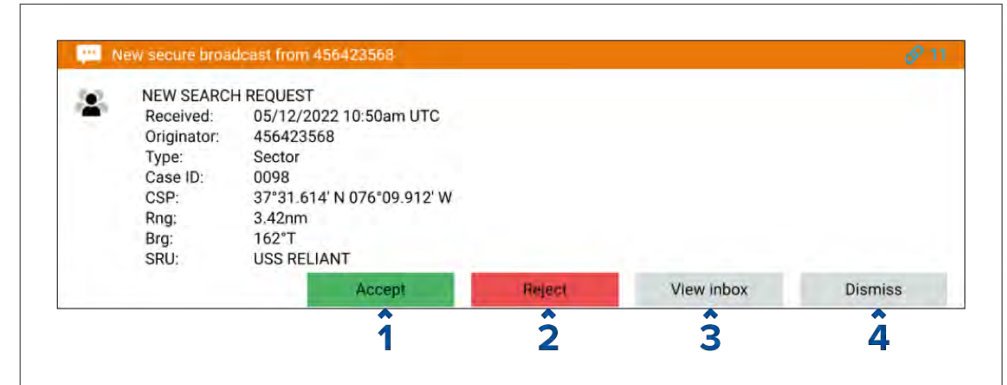

Note:

An SMC can only specify a resume point once the SRU has initiated the divert.

1. Select the SAR pattern onscreen to open the context menu and then select *[Instruct SRU to Resume]* from the pop-over options.

The [Instruct SRU to Resume] option can also be selected from:

- The SRU BlueForce target icon's context menu.
- The SMC searches list pop-over options (if the SMC searches list is accessed from the Homescreen rather than from the Chart app menu you can only select a waypoint from the waypoint list or enter the lat/long coordinates for the divert point).
- The message's pop-over options from the messages inbox.

2. Choose a point along the search route or a waypoint ahead of the divert location and then select *[Resume from here]* from the context menu.
3. Select *[Send now]*.

1. *[Accept]*— Imports the SAR pattern and displays the search in the All searches list. The SMC will receive automatic notification confirming that you have accepted the search.
2. *[Reject]*— Closes the notification without importing the SAR pattern. The SMC will receive automatic notification confirming that you have rejected the search.
3. *[View inbox]*— Closes the notification and opens the messages inbox so that you can view the related message. The search can be accepted or rejected from the inbox message's pop-over options. No automatic notification is sent when *[View inbox]* is selected, and the SMC will be waiting for the SAR pattern to be accepted or rejected.
4. *[Dismiss]*— Selecting dismiss will close the notification. The search can be accepted or rejected from the inbox message's pop-over options. No automatic notification is sent when *[Dismiss]* is selected and the SMC will be waiting for the SAR pattern to be accepted or rejected.

SRU action — Accepting a SAR pattern

To accept, import and start following a SAR pattern when assigned as SRU follow the steps below:

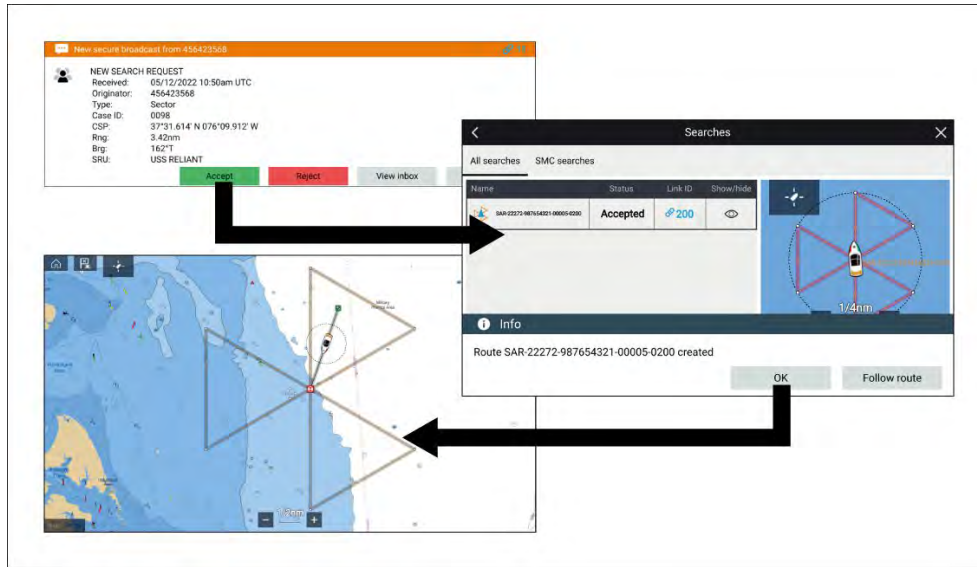

1. Select *[Accept]* from the onscreen notification.

Alternatively you can select [Accept search] from the related message's pop-over options in the messages inbox.

2. Select *[Follow route]* from the notification.

Follow route can also be selected from the All searches list and the Chart app context menu.

The search pattern is followed in the same way as any other route, unless a diversion is required.

Search pattern waypoint arrival alarm

When following a search pattern the waypoint arrival alarm will be triggered when entering the specified arrival radius and also when passing perpendicular to the waypoint.

The *[Search route arrival radius]* setting determines the radius/distance from the waypoint that the waypoint arrival alarm is triggered. The *[Search route arrival radius]* can be checked and adjusted from the *[Alarms]* menu: *[Homescreen > Alarms > Settings > Search route arrival radius]*.

[SAR \(Search And Rescue\) patterns](#)

The waypoint arrival alarm can be configured to only trigger when the arrival radius is reached and not when passing perpendicular by selecting *[Radius only]* from the bottom of the *[Advanced]* Chart app settings menu: *[Menu > Settings > Advanced > Waypoint arrival (Search routes)]*.

SRU search controls

When performing a search as an SRU, search controls are available to help you manage the search.

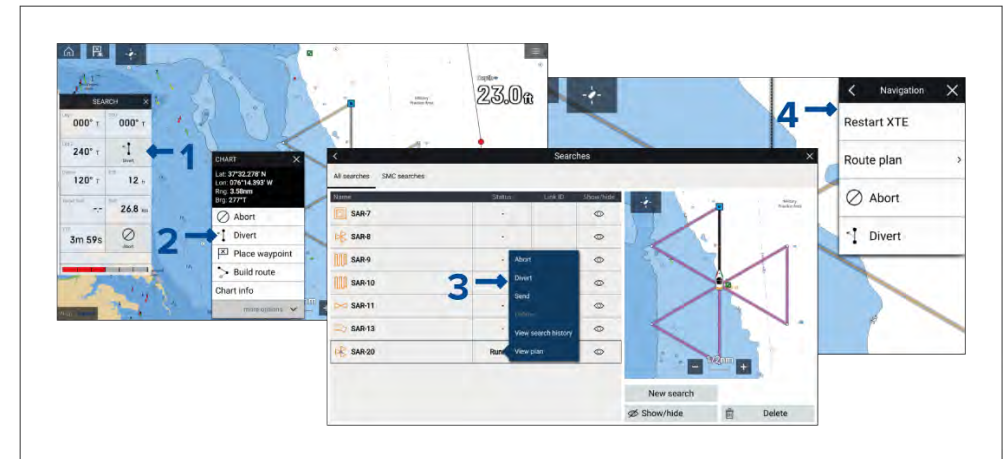

The controls can be accessed from the search sidebar (1), the chart app context menu (2), the searches list (3), and the Navigate menu (4).

The following options are available:

Divert controls

- *[Divert]*— This option is available when you are following the search pattern. Selecting Divert allows you to record a diversion from the search.
- *[End divert]*— This option is available when you have diverted from the search pattern (i.e.: once Divert has been selected). Selecting End divert allows you to navigate back to the point at which you diverted from the search.
- *[Resume]*— This option is available when you are travelling back to a diversion point. Selecting Resume will navigate to the next waypoint in the search.

Other

- *[Abort]*— The abort option is available when you are following the search pattern. Selecting Abort will stop the route follow and abort the search.

SRU action — Diverting from a SAR pattern

If you need to divert from a search to investigate a point or area of interest not covered by the SAR pattern, the *[Divert]* and *[End divert]* options should be used. This will ensure that the SMC is notified of the diversion.

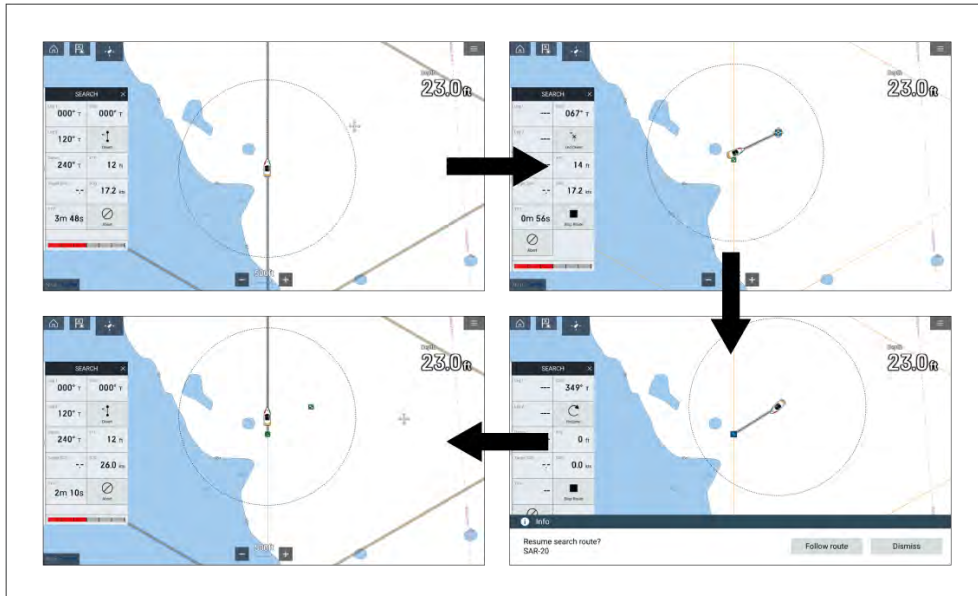

1. Select *[Divert]*.

Active navigation of the SAR pattern will stop and a divert marker will be placed at your vessel's location.

Note:

At any time during a divert you can resume the search from any waypoint in the SAR pattern that is ahead of the divert marker, by selecting *[Resume from here]* from the waypoint's context menu. Active navigation of the SAR pattern will resume from the chosen waypoint.

2. Perform manual navigation or perform other active navigation such as a *[Goto]* to navigate to the point or area of interest.

3. Once you have completed the divert, select *[End Divert]*.

The resume search notification is displayed.

4. Select *[Follow route]* to start active navigation back to the divert marker (the point you left the SAR pattern), or select *[Dismiss]* to resume the search at a later time.

Note:

If you select *[Dismiss]*, the SMC will see your status as 'Resuming' until you have resumed the search. To resume the search, select *[Resume]* from one of the following locations:

- The search sidebar.
- The chart app *[Navigation]* menu.
- The SAR pattern context menu.
- The related inbox message options.
- The waypoint options from the SAR route plan list.

The resume search notification is displayed and you can select *[Follow route]* to resume active navigation of the SAR pattern from the divert marker.

5. Once you reach the original divert marker, select *[OK]* on the waypoint arrival alarm.

Active navigation of the SAR pattern will be resumed and the SMC will be updated that you have resumed the search.

SRU divert as instructed — overview

During a managed search, the SMC may instruct the SRU to divert from the search pattern to investigate a point or area of interest not covered by the SAR pattern.

When an instruction to divert is received, a notification is displayed onscreen and a "Divert to" marker is shown in the Chart app.

The SMC may also include instructions of the position within the search pattern to divert from. In this situation, a corresponding "divert from here" marker will be shown in the Chart app. If no "Divert From here" marker was included, the divert should take place ASAP, but at the SRU's discretion.

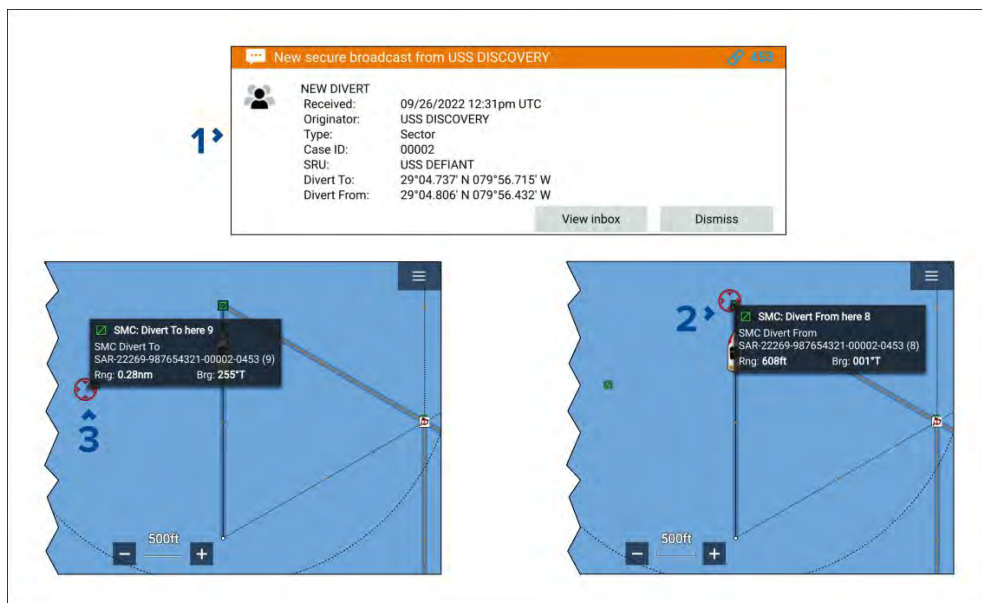

1. **SMC divert notification** — From the notification you can *[View inbox]* or *[Dismiss]* the notification.
2. **“Divert From here” marker** — If a “Divert From here” marker is included in the instruction, when the marker is reached the waypoint arrival alarm is displayed. Select *[Divert now]* and active navigation to the “Divert To here” marker will commence.
3. **“Divert To here” marker** — When the “Divert To here” marker is reached, select *[End divert]* from the context menu and then *[Follow route]* from the notification to resume the search from the “Divert From here” marker.

SRU action — Diverting as instructed by SMC

Below is an example of SRU actions for an instructed divert that includes both “Divert To” and “Divert From” markers.

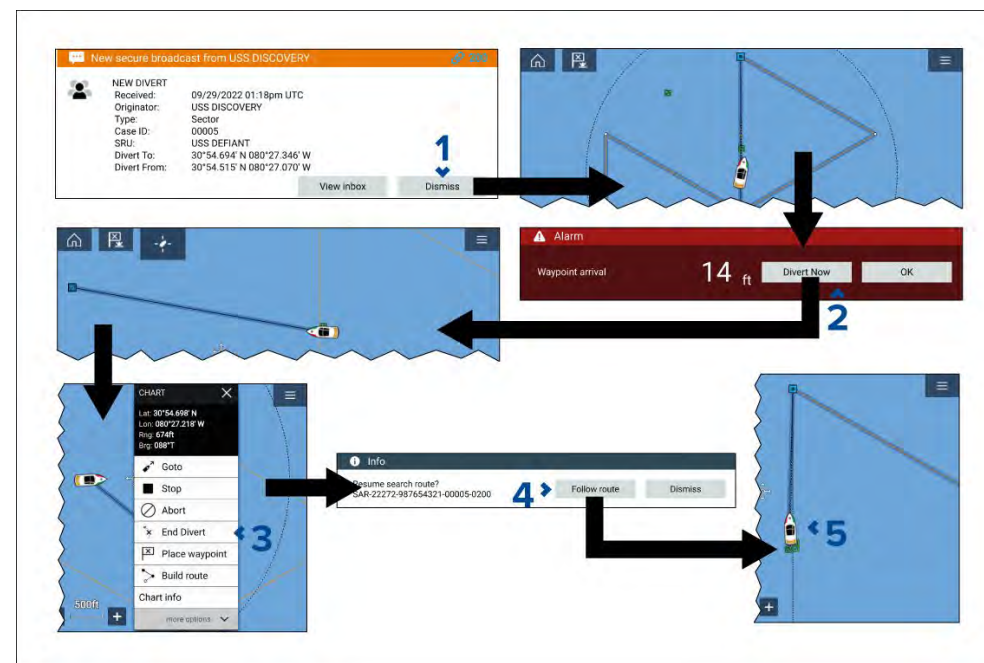

1. Select *[Dismiss]* from the divert notification.
2. When the “Divert From here” marker is reached, select *[Divert now]* from the waypoint arrival notification.
Active navigation will commence to the “Divert To here” marker.
3. Once the divert is complete, select *[OK]* on the waypoint arrival notification and then select *[End divert]* from the chart context menu.
4. Select *[Follow route]* from the notification.
Active navigation will commence back to the “Divert From here” marker.
5. Select *[OK]* on the waypoint arrival alarm.
Active navigation of the search pattern will recommence.

SRU action — Resuming from SMC instructed point

During an SMC instructed divert, the SMC may instruct you to resume from a different location in the SAR pattern than the point you originally diverted from.

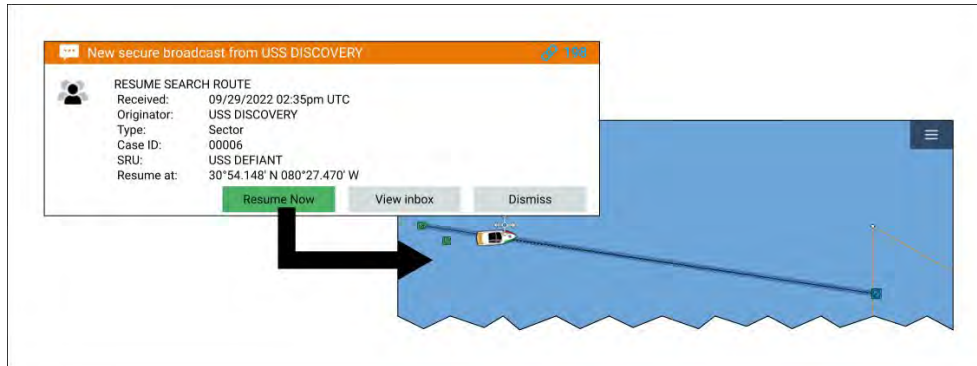

1. Select *[Resume Now]* from the notification.
A “Resume here” marker is displayed, and active navigation will commence to the waypoint.
2. Once the “Resume here” marker is reached, select *[OK]* on the waypoint arrival notification.
Active navigation of the search pattern will recommence.

12.11 Searches lists

SAR patterns are managed from the searches lists.

The searches list can be accessed from the Chart app menu: *[Menu > Waypoints, routes, tracks > Searches]*, or from the My Data menu: *[Homescreen > My data > Searches]*. When accessed from the chart app, the LiveView pane will be displayed and the *[Show on chart]* options are available.

All searches list

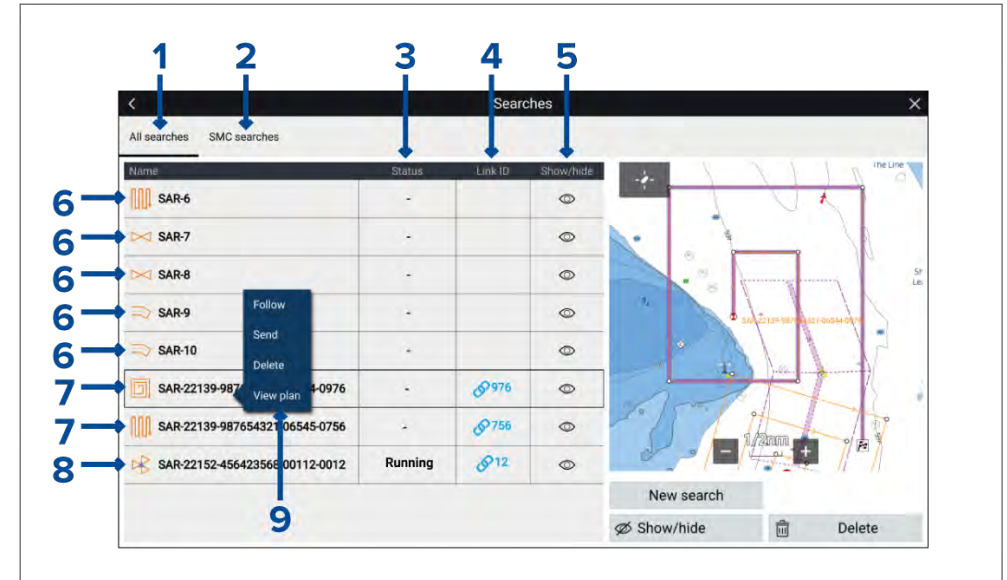

1. The *[All searches]* tab contains a list of all broadcast and received SAR patterns.
2. The *[SMC searches]* tab contains only managed searches where your vessel is the SMC.
3. The status field identifies the status of received managed searches where your vessel is the SRU. SAR patterns that have been created on your system will not have a status.
4. The link ID field shows the relevant STEDs messaging link ID number.
5. You can hide/show SAR patterns in the chart app by selecting the icon.
6. Shows examples of SAR patterns either created on your system (which have not been broadcast), or patterns that have been received as an un-managed SAR pattern.
7. Shows examples of managed SAR patterns that have been broadcast by your vessel. To see search status, view the SMC searches list.
8. Shows example of a received SAR pattern where your vessel has been assigned as the SRU. The status field will identify your progress.
9. The SAR pattern pop-over menu provides SAR options and SRU SAR controls.

SMC searches list

The SMC searches list contains only managed searches where your vessel is the SMC.

The SMC searches list will identify the SRU, status, link ID and case ID for each managed search broadcast by your vessel.

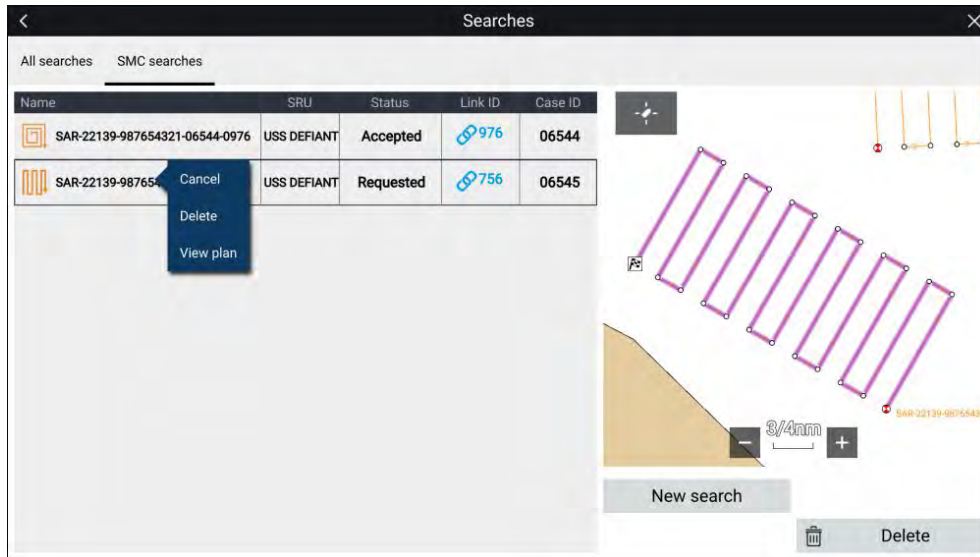

The SMC can cancel a broadcast SAR pattern from the SMC searches list by selecting *[Cancel]* from the SAR pattern pop-over menu. The cancellation is automatically broadcast.

Search history

Each event (e.g.: “Started”, “Divert”, “Resume” etc.) of a managed search is recorded. The search history can be accessed from the searches list.

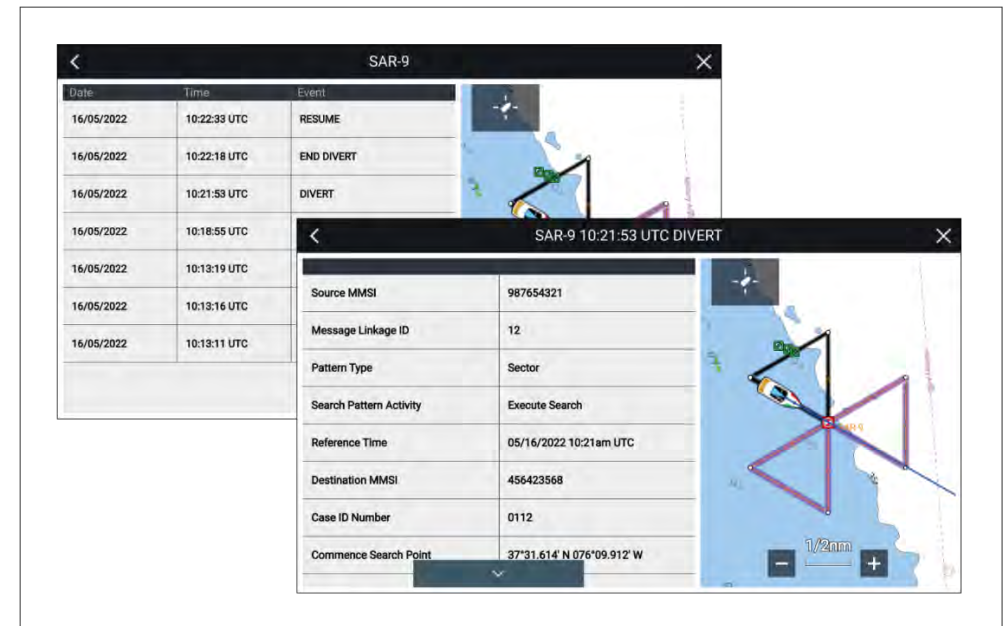

Each event in the history list can be selected to display more details about each event.

CHAPTER 13: CHART APP - GENERAL

CHAPTER CONTENTS

- 13.1 Chart app chapters — page 191
- 13.2 Chart app overview — page 191
- 13.3 Cartography overview — page 202
- 13.4 LightHouse charts — page 203
- 13.5 S-63 Encrypted Charts — page 206
- 13.6 Navigation — page 210
- 13.7 Rudder bar indicator — page 218
- 13.8 Depths and contours — page 218
- 13.9 Target tracking — page 223
- 13.10 Collision avoidance — page 230
- 13.11 Target intercept — page 238
- 13.12 Reeds almanac — page 239
- 13.13 Find nearest — page 239
- 13.14 Measure — page 241
- 13.15 ClearCruise™ Augmented Reality — page 242
- 13.16 Chart settings menu — page 243

13.1 Chart app chapters

This document includes a chart app chapter for each of the available chart modes. The *Chart app – general* chapter provides details of features and functions common to all chart app modes.

To view details about chart mode specific features and settings refer to the relevant chart app chapter:

- [p.252 – Chart app - Navigate mode](#)
- [p.254 – Chart app - Fishing chart mode](#)
- [p.257 – Chart app - Fish mapping mode](#)
- [p.262 – Chart app - Weather mode](#)
- [p.275 – Chart app - Tides mode](#)
- [p.281 – Chart app - Anchor mode](#)
- [p.286 – Chart app - Racing mode](#)

13.2 Chart app overview

The chart app displays a representation of your vessel in relation to land masses and other charted objects, which enables you to plan and navigate to your desired destination. The Chart app requires a GNSS (GPS) position fix in order to display your vessel at the correct location on a world map. For the chart app to recognise vessel direction, a heading sensor is recommended. If heading data is not available, a stable source of Course Over Ground (COG) data may be used instead.

The chart app uses chart modes to configure the chart screen and settings for the relevant activity. For details on available chart modes, refer to: [p.196 – Chart modes](#)

For each instance of the chart app, you can select which chart mode and which electronic cartography you want to use. The selection will be saved and persist over a power cycle.

The chart app can be displayed in both fullscreen and splitscreen page layouts. A single App page may consist of up to 4 instances of the chart app.

If you are underway and using a chart mode that is not suitable for navigation, it is recommended that you create a splitscreen app page and use navigate mode in one of the splitscreen panes.

Below is an overview of features available in the chart app. Some features may not be available in all chart modes. If a required setting option or feature is not available, try changing the chart mode.

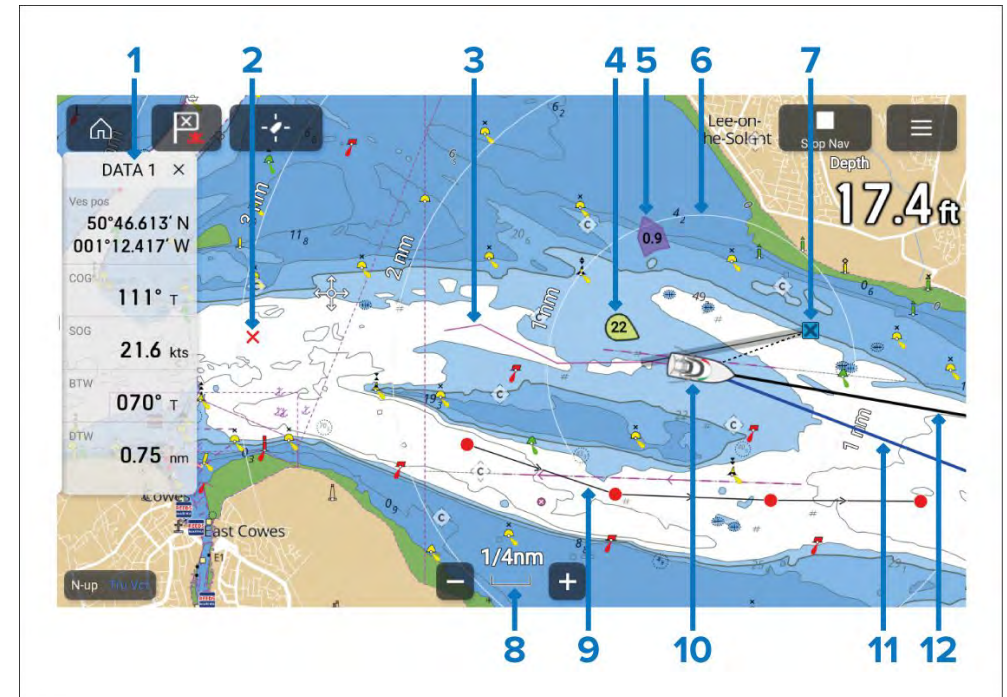

1. **Sidebar** — The Sidebar contains system data that can be viewed in all apps.
2. **Waypoint** — Use waypoints to mark specific locations or points of interest (POI).
3. **Track** — Record the passage your vessel takes.
4. **Wind indicator** — Provides indication of wind direction and speed (Wind transducer required).
5. **Tide indicator** — Provides tide Set and Drift indicators. Requires the following data: COG (Course Over Ground), Heading, SOG (Speed Over Ground), and STW (Speed Through Water).
6. **Range rings** — Provides a distance indication around your vessel at set intervals.
7. **Destination waypoint** — During a Goto operation, this is the current destination waypoint.

8. **Chart range** — Identifies the scale for the displayed Chart range.
9. **Route** — You can plan your route in advance by creating a Route using Waypoints to mark each route leg.
10. **Vessel icon** — This icon represents your vessel, and is only displayed when a GNSS (GPS) position fix is available. The icon will be a black dot if no Heading is available.
11. **COG line** — If COG data is available, you can display a COG (Course Over Ground) vector for your vessel.
12. **Heading line** — If Heading data is available, a Heading vector for your vessel can be displayed.

Chart app onscreen controls

Onscreen controls are available which are overlaid in fixed positions onscreen.

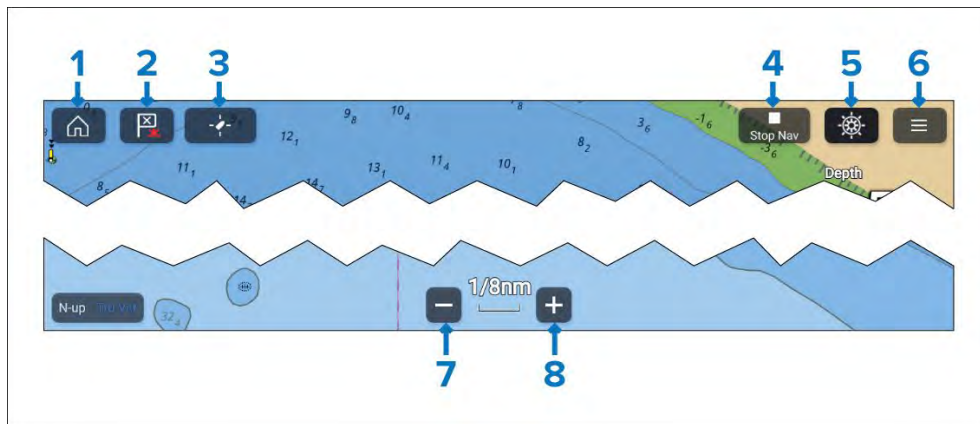

1. **Home** — Select to return to the Homescreen.
2. **Waypoint / MOB** — Select to place a waypoint at your vessel's location, or press and hold to activate Man overboard (MOB) alarm.
3. **Find vessel** — Select to center the vessel icon on the screen. Only displayed when the vessel is not centred.
4. **Stop Nav** — Select to end active navigation (i.e.; goto or route follow). Only shown during active navigation.
5. **Pilot** — Select to open the Pilot sidebar. Only displayed when autopilot integration is enabled.
6. **Menu** — Select to open the Chart app menu.

7. **Range out** — Select to zoom out and show a larger area onscreen.
8. **Range in** — Select to zoom in and show a smaller area onscreen.

Chart app simulator

When using a demo profile, navigation can be simulated in the Chart app.

Note:

- When a demo profile is active, all data will be **simulated** by the MFD.
- Alarms raised by real sensor data will not be triggered.
- **Demo profiles should NOT be used whilst navigating.**
- Any networked MFDs will also switch to demo mode.

You can perform a *[Goto]*, *[Follow]* a route, or navigate manually using the onscreen controls. The onscreen controls can only be accessed using the touchscreen.

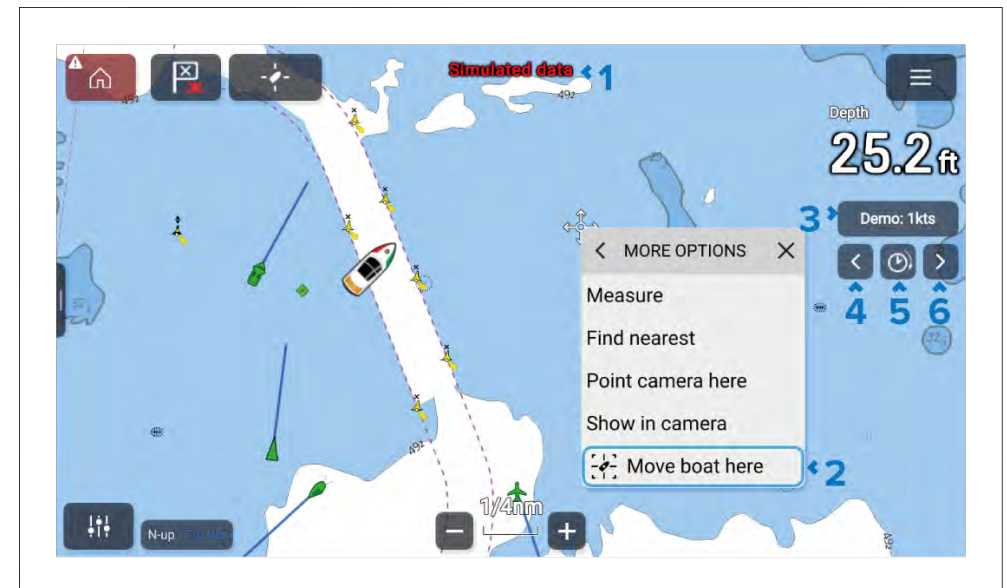

1. When a demo profile is active, a “Simulated data” message will flash at the top of the screen.

- You can move the boat symbol to any location using the context menu. To do this, use the touchscreen to tap and hold at the required location on the chart, and then select *[More options]* and *[Move boat here]*.
- Select the *[Demo]* button to adjust the simulated speed of the boat symbol.
- Press the *[Left arrow]* button to change the heading to port in 1° increments, or tap and hold to keep incrementing.
- Press the *[Time]* button to increase the speed of the simulation, or tap and hold to keep increasing the simulation speed.
- Press the *[Right arrow]* button to change the heading to starboard in 1° increments, or tap and hold to increment continuously.

Chart ranging and panning

You can change the range displayed in the Chart app using the onscreen Range controls or by using the pinch-to-zoom touch gesture.

You can pan the chart area by swiping your finger across the chart. When the chart is panned the Chart app will enter cursor mode and remain fixed until motion mode is activated by select the *[Find ship]* icon.

Quick adjust menu

The Chart app includes a *[Quick adjust]* menu which provides quick access to some common *[Layer]*, *[Vectors]* and *[View]* options, as well as *[Recent]* waypoints and routes.

Note:

[Quick adjust] can only be accessed using the touchscreen.

The *[Quick adjust]* menu is accessed by selecting the *[Quick adjust]* icon located in the bottom left corner of the screen.

The *[Quick adjust]* menu is available in the following Chart modes:

- [Navigate]*
- [Fishing]*
- [Anchor]*
- [Racing]*

AIS and Radar options will only be available if compatible hardware is detected.

The following options are provided:

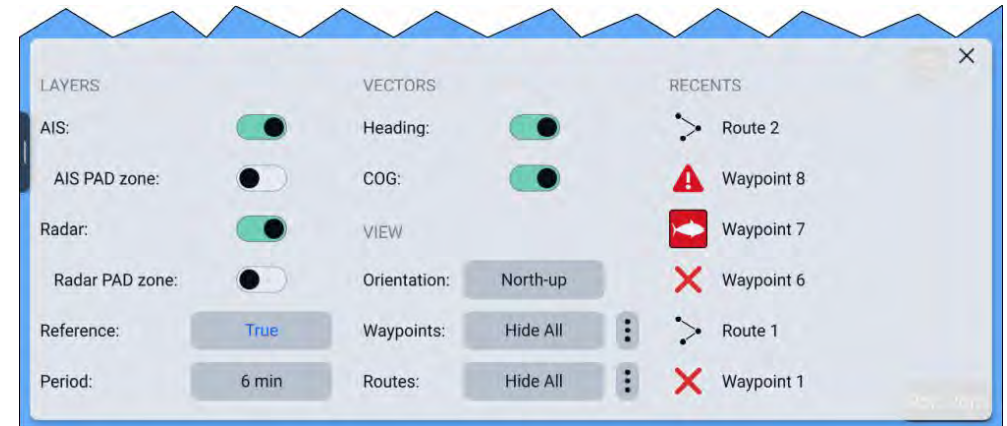

LAYERS

- [AIS]*— Switches AIS layer on and off.
- [AIS PAD zone]*— Switches display of Predicted Area of Danger (PAD) zones on or off for AIS targets.
- [Radar]*— Switches Radar layer on or off.
- [Radar PAD zone]*— Switches display of Predicted Area of Danger (PAD) zones on or off for Radar targets.
- [Radar PAD zone]*— Switches display of Predicted Area of Danger (PAD) zones on or off for Radar targets.
- [Reference]*— Switches Radar reference mode between *[True]* and *[Relative]*.
- [Period]*— Adjust the vector time period.

VECTORS

- [Heading]*— Switches own vessel Heading vector on or off.
- [COG]*— Switches own vessel COG vector on or off.

VIEW

- [Orientation]*— Changes the Chart app's Orientation mode.
- [Waypoints]*— Shows or hides all waypoints. Selecting the "3 dots" icon displays the Waypoint list.
- [Routes]*— Shows or hides all routes. Selecting the "3 dots" icon displays the Routes list.

RECENTS

- Up to 6 recently used routes and/or waypoints can be listed. Selecting an item in the Recents list will close the menu and zoom to and highlight the selected item on the Chart app screen.

Context menu

The Context menu provides menu options relevant to the cursor location or selected object.

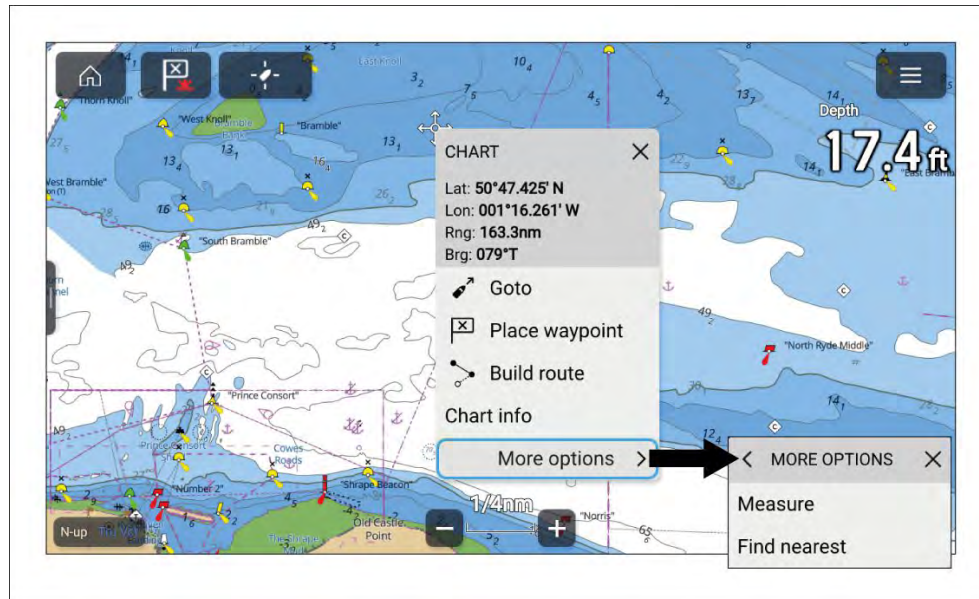

Press and hold on a location or object to open the context menu. Alternatively highlight the location or object and press the physical *[OK]* button.

The context menu provides Latitude, longitude, range and bearing details for the selected location or object.

Selecting *[More options]* will show further available options.

AIS target context menu

When an AIS target is selected in the Chart app, the AIS target context menu is displayed.

The AIS target context menu includes the following information and settings:

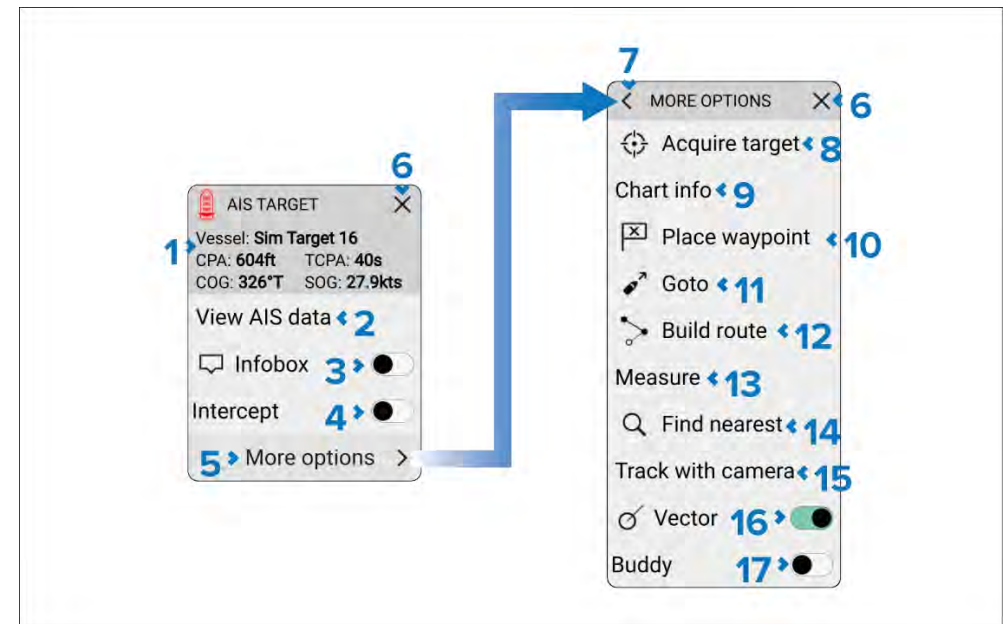

- AIS data — The following AIS data is displayed:
 - Vessel name.
 - CPA (Closest Point of Approach) and TCPA (Time to Closest Point of Approach).
 - Course (COG or relative course).
 - Speed (SOG or relative speed).
- [View AIS data]*— View full page AIS data report.
- [Infobox]*— Enable and disable onscreen display of AIS data next to the target symbol.
- [Intercept]*— Enable and disable target interception.
- [More options]*— View further options.
- [X]* (close) — Close the context menu.
- [<]* (back arrow) — Go back to first context menu.
- [Acquire target]*— Acquire the AIS target as a Radar target.
- [Chart info]*— View details of any nearby objects.
- [Place waypoint]*— Create a new waypoint at the target's current location.
- [Goto]*— Perform a goto.

12. *[Build route]*— Create a route.
13. *[Measure]*— Use or remove the ruler tool.
14. *[Find nearest]*— Search for nearby point of interest.
15. *[Track with camera]*— Track the target with a compatible PTZ (Pan Tilt Zoom) camera.
16. *[Vector]*— Enable and disable target vectors.
17. *[Buddy]*— Add or remove target from Buddy list.

First responder

When the display is configured using the *First Responder* activity, the following additional data and options will be available:

- AIS data — Boat type, Status, Bearing, Range, Intcpt (Intercept time).
- *[Designate TOI]*.
- *[Send message]*.

Radar target context menu

When an acquired Radar target is selected in the Chart app, the Radar target context menu is displayed.

The Radar target context menu includes the following information and settings:

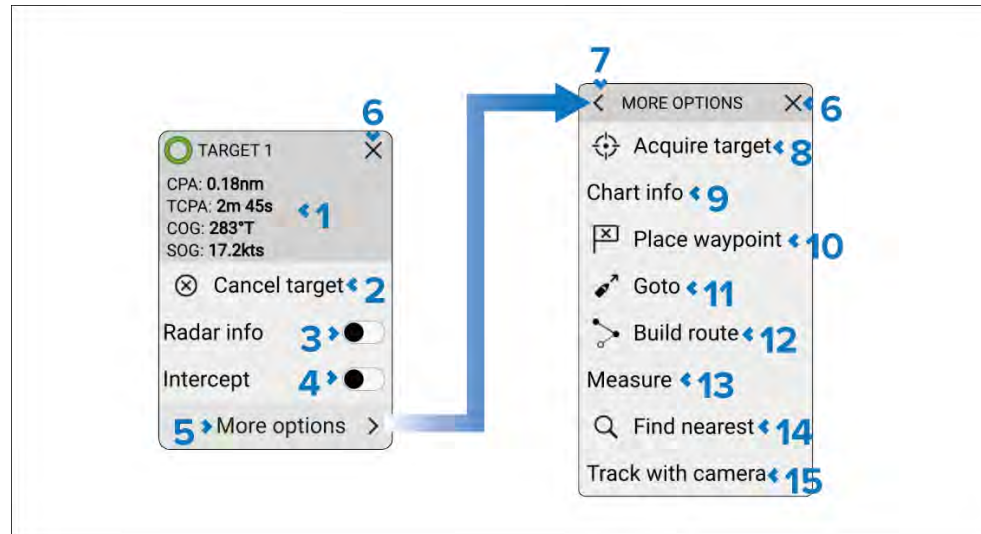

1. Target data — The following data is displayed:

- CPA (Closest Point of Approach) and TCPA (Time to Closest Point of Approach).
 - Course (COG or relative course).
 - Speed (SOG or relative speed).
2. *[Cancel target]*— Delete the selected Radar target.
 3. *[Target info]*— Enable and disable onscreen display of data next to the target symbol.
 4. *[Infobox]*— Enable and disable onscreen display of AIS data next to the target symbol.
 5. *[Intercept]*— Enable and disable target interception.
 6. *[More options]*— View further options.
 7. *[X]*(close) — Close the context menu.
 8. *[<]*(back arrow) — Go back to previous context menu.
 9. *[Acquire target]*— Acquire the AIS target as a Radar target.
 10. *[Chart info]*— View details of any nearby objects.
 11. *[Place waypoint]*— Create a new waypoint at the target’s current location.
 12. *[Goto]*— Perform a goto.
 13. *[Build route]*— Create a route.
 14. *[Measure]*— Use or remove the ruler tool.
 15. *[Find nearest]*— Search for nearby point of interest.
 16. *[Track with camera]*— Track the target with a compatible PTZ (Pan Tilt Zoom) camera.

First responder

When the display is configured using the *First Responder* activity, the following additional data and options will be available:

- AIS data — Boat type, Status, Bearing, Range, Intcpt (Intercept time).
- *[Designate TOI]*.
- *[Send message]*.

Selecting cartography

Appropriate cartography must be used for navigation. If desired you can select a different cartography for each instance of the chart app. The selected cartography will be remembered the next time that chart app instance is opened. If no cartography is detected the *[Chart app]* will default

to Lighthouse Charts basemap. The first time a chart app instance is opened if multiple cartography is detected the app will default to using LightHouse™ charts.

Important:

Basemaps should not be used for navigation.

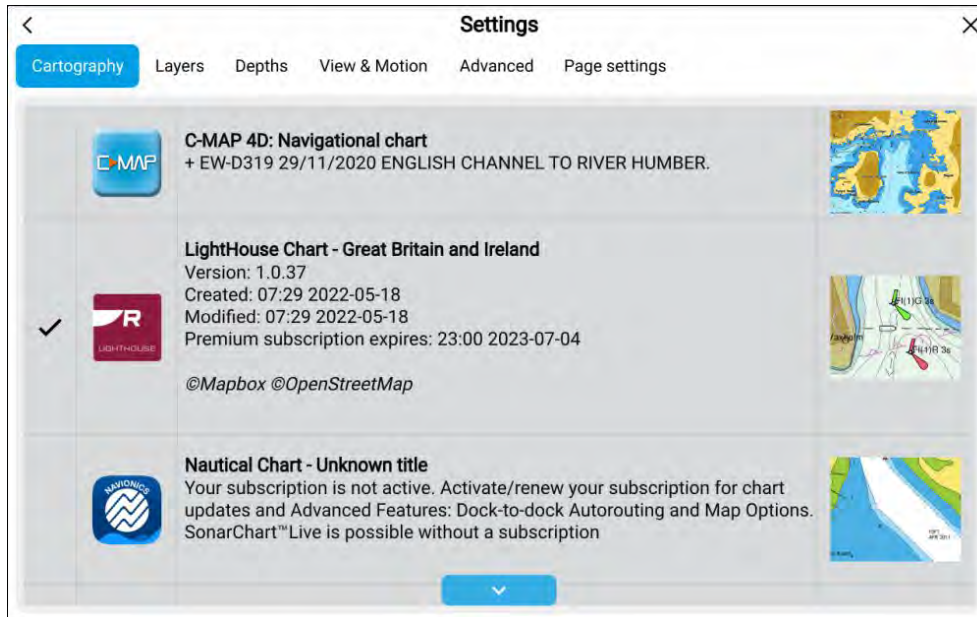

From the Chart app menu:

1. Select the *[Settings]* icon.
2. Select the cartography that you want to use from the *[Cartography]* tab.

The menu will automatically close and the chart app will refresh to display your selected cartography.

Chart modes

The Chart app provides preset modes that can be used to quickly set up the Chart app for your intended use.

Note:

The example images below are used when the Homescreen icons are set to *[Classic icons]*. If Homescreen icons are set to *[Mode icons]* then the icons used on the Homescreen will be used instead. For details of Mode icon refer to: [p.90 – Chart app](#)

To change Chart mode select the required mode from the app menu.

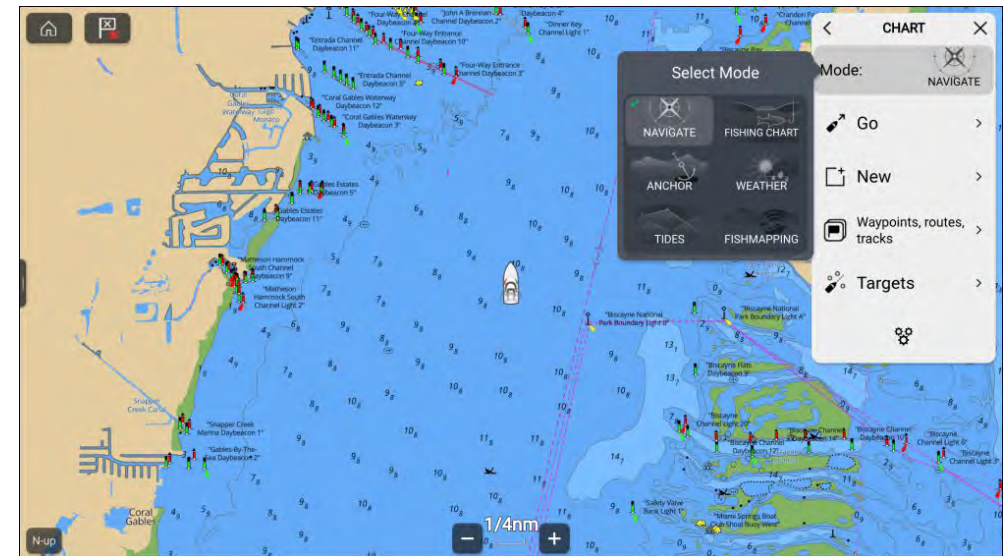

The following chart modes are available:

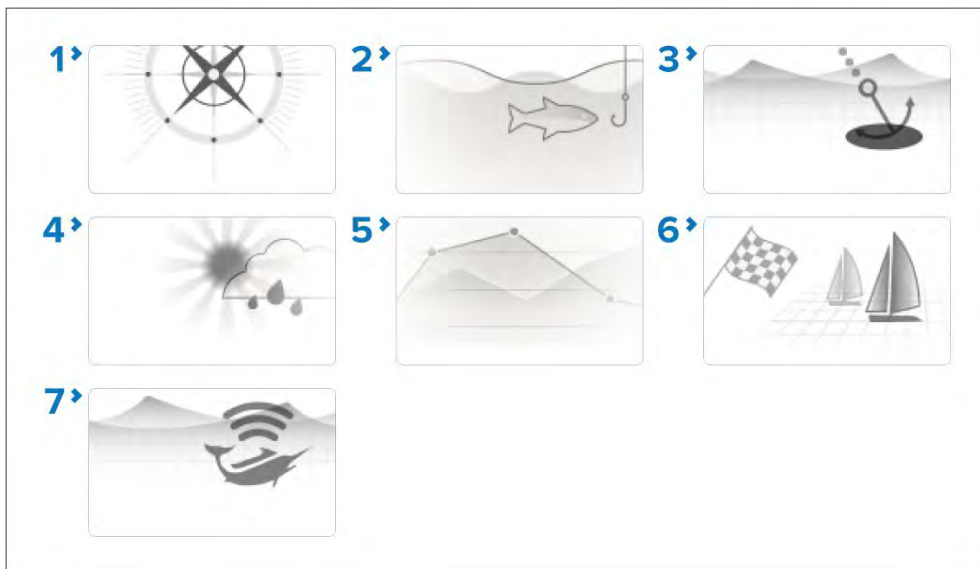

1. *[NAVIGATE]* — Navigate is the default mode. Full chart detail and menu options are available. Settings changes are saved to the user profile in use. For details refer to: [p.252 — Chart app - Detailed mode](#)
2. *[FISHING CHART]* — Fishing mode optimizes the chart app for Fishing and if supported by your selected cartography, displays more detailed contour lines. Full menu options are available. Settings changes are saved to the user profile in use. For details refer to: [p.254 — Chart app - Fishing chart mode](#)
3. *[ANCHOR]* — Anchor mode optimizes the chart app for anchoring and provides access to the anchoring wizard so that the anchor drag alarm parameters can be configured. Full menu options are available in Anchor mode, and any settings changes are saved to the user profile in use. For details refer to: [p.281 — Chart app - Anchor mode](#)
4. *[WEATHER]* — Weather mode allows you to overlay weather data directly on the chart and view animated weather graphics or read weather reports. Settings changes are saved to the user profile in use. Weather mode is available when the MFD is connected to a SR150 or SR200 Sirius receiver. and requires a SiriusXM weather subscription. For details refer to: [p.262 — Chart app – Weather mode](#)
5. *[TIDES]* — In tides mode, tide station and current station icons are replaced with graphics representing tide and current conditions. Animation controls are displayed that enable playback of tide and

current predictions over a 24 hour period. For details refer to:

[p.275 — Chart app - Tides mode](#)

6. *[RACING]* — Racing mode optimizes the chart app for Race Sailing. Racing mode is available when the MFD is configured using the Sailing boat activity. In racing mode the race start line and race timer options are available from the menu, allowing you to create a start line and countdown timer which can help optimize your racing start. For details refer to: [p.286 — Chart app - Racing mode](#)
7. *[FISHMAPPING]* — Fish mapping mode enables you to overlay fish mapping layers and fish types directly on the chart. Settings changes are saved to the user profile in use. Fish mapping mode is available when the MFD is connected to an SR200 Sirius receiver and requires a SiriusXM fish mapping subscription. For details refer to: [p.257 — Chart app - Fish mapping mode](#)

Vessel icon

The vessel icon is used to show your vessel's current GNSS position.

The vessel icon can be changed from the *[Boat details]* settings menu: *[Homescreen > Settings > Boat details > Boat type]*.

Chart motion mode

The *[chart motion]* setting controls the relationship between the chart and you vessel.

3 chart motion modes are available:

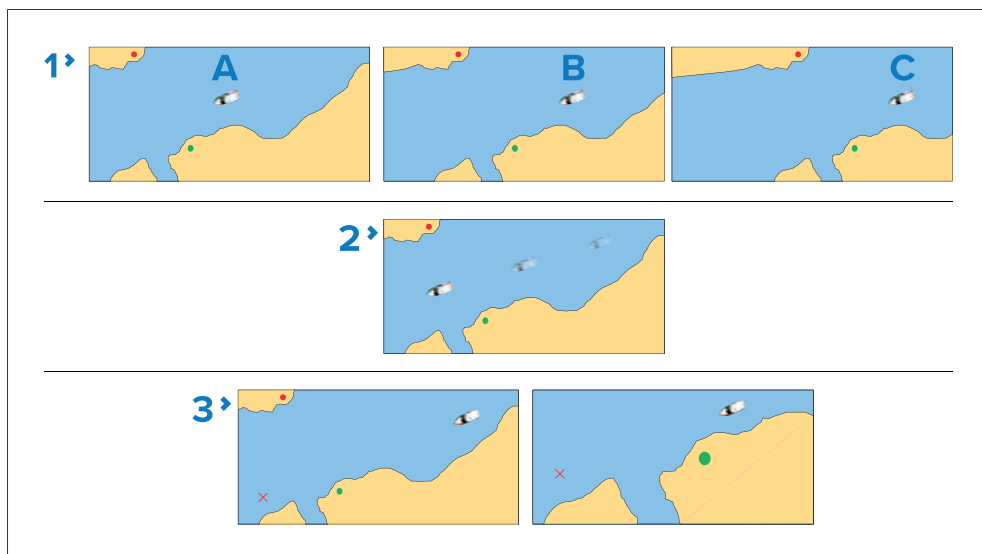

1. *[Relative motion]*— Relative Motion mode fixes your vessel’s icon position and the chart image moves relative to your vessel. In Relative Motion mode you can use the *[Boat position]* setting to determine whether the vessel is fixed in the *Center* of the chart display or has a *Partial offset*, or *Full offset*. Selecting the partial or full offset has the effect of increasing the view ahead of your vessel icon on the chart display.
2. *[True motion]*— True Motion mode fixes the chart position and the vessel icon moves in true perspective to the fixed land masses shown on the screen. As the vessel’s position approaches the edge of the screen, the chart image is automatically redrawn to reveal the area ahead of the vessel.

Note: True Motion mode is not available when the Radar orientation is set to “Head-up”.

3. *[Auto range]*— Auto Range mode ensures that the largest possible chart scale will always and automatically be maintained, to display both the vessel and the target waypoint on-screen at the same time.

Boat position is not available in *[True motion]* or *[Auto range]* modes..

The *[Chart motion]* and *[Boat position]* options are available from the *[View & Motion]* settings menu: *[Menu > Settings > View & Motion]*.

Chart orientation

The orientation setting determines how the chart is orientated in relation to you vessel’s direction of travel.

The following chart orientations are available:

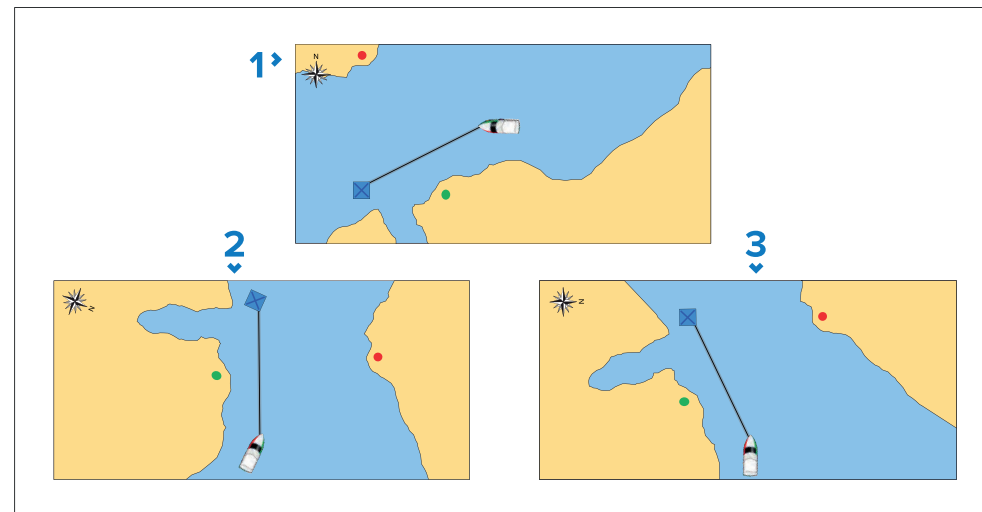

1. *[North-up]*— The chart is orientated so that true north is always upward on the screen. As your vessel changes direction, vessel icon rotates accordingly to show your relative position to true north North up is the default chart orientation.
2. *[Course-up]*— The chart is orientated so as to show your current course directly ahead of your vessel icon. The chart will rotate so that your COG is always upward on the screen.
3. *[Head-up]*— In Head-up mode the vessel’s heading always points directly up. As your heading changes the chart rotates accordingly. In Head-up mode if heading data is not available then stable COG is used instead. If heading or COG is not available then Head-up mode is suspended and the chart will orientate to display 0 degrees directly up if there is no active navigation or Course-up if there is active navigation.

Note:

- To prevent constant rotations as the vessel yaws the chart will not update unless the heading changes by at least 10 degrees from the last displayed orientation.
- Head-up mode is not available when chart motion is set to *[True motion]*.

The *[Chart orientation]* setting is available from the *[View & Motion]* settings menu: *[Menu > Settings > View & Motion]*.

Vessel details

The vessel details pop-over provides access to vessel-related settings.

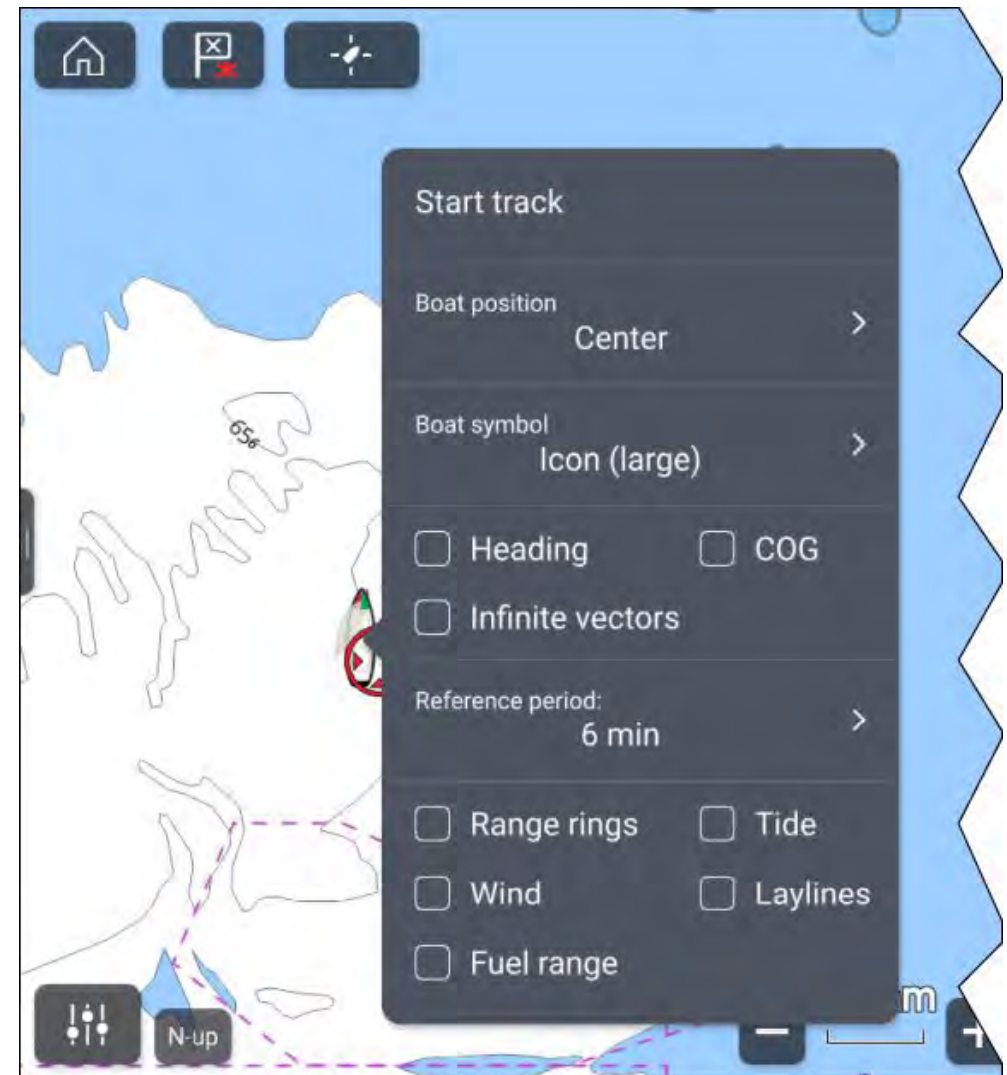

From the vessel details pop-over you can:

- Start or stop recording a track by selecting *[Start/track]* / *[Stop track]*.
- Change the vessel symbol's position by selecting a *[Boat position]* option.

- Change the symbol used to represent your vessel by selecting a *[Boat symbol]* option.
- Show or hide vessel heading vector line by ticking or unticking the *[Heading]* tick box. By default the heading vector length is determined using STW (Speed Through Water) received from a speed transducer, you can use SOG instead by enabling the *[Use SOG for hdg vector length]* from the *[Advanced settings]* menu: *[Menu > Settings > Advanced]*.
- Show or hide vessel COG vector line by ticking or unticking the *[COG]* tick box.
- Use infinite or reference period line length for vectors by ticking or unticking the *[Infinite vectors]* tick box.
- Set the length of vectors when not using *[Infinite vectors]* by selecting a *[Reference period]* option. Vector length is measured in minutes and shows your expected position after the selected time has elapsed.
- Show or hide range rings around your vessel by ticking or unticking the *[Rng rings]* tick box.
- Show or hide the tide vector graphic by ticking or unticking the *[Tide]* tick box.
- Show or hide the wind vector graphic by ticking or unticking the *[Wind]* tick box.
- Show or hide layline graphics by ticking or unticking the *[Laylines]* tick box. The Laylines option is only available when your MFD has been configured using the *[Sailing]* boat activity.
- Show or hide the *[Fuel range]* ring.

Note:

In weather mode and fishmapping mode the only option available is *[Start/track]* / *[Stop track]*.

Chart mode specific behavior

Depending on chart mode some options are enabled by default:

- Tides mode — Heading, COG and Tide.
- Anchor mode — COG, Tide and Wind.
- Racing mode — Heading, COG, Tide, Wind and Laylines.
- Navigate mode — Laylines when your MFD has been configured using the *[Sailing]* boat activity.

Vessel detail option changes are saved for each chart mode in the current chart app instance.

Fuel range

A fuel range ring is available in the Chart app which indicates the maximum range that can be achieved travelling in a straight line.

The indicated range is an estimate based on data received from your engine management system, or from the LightHouse™ Fuel manager. The range is an approximate value only, and does not take into account conditions such as sea state, wind, or tidal currents. **The fuel range ring provides an estimate only, and should not be relied upon for accurate navigation.**

The *[Fuel range]* ring is enabled and disabled from the *[Vessel details]* pop-over menu.



1. *[Fuel range]* ring option in the *[Vessel details]* pop-over menu.
2. Fuel range ring.
3. A Fuel symbol is placed at the point where your vessel's current heading and your estimated fuel range intersect.

Note:

When the vessel is close to either the North or South poles, the circle cannot be drawn above or below the chart area limits, and will instead appear as an arc.

Charted objects

Charted objects can be selected and information about the object can be viewed.



When the cursor is over a charted object it will change to the Object cursor.

Cursor info box

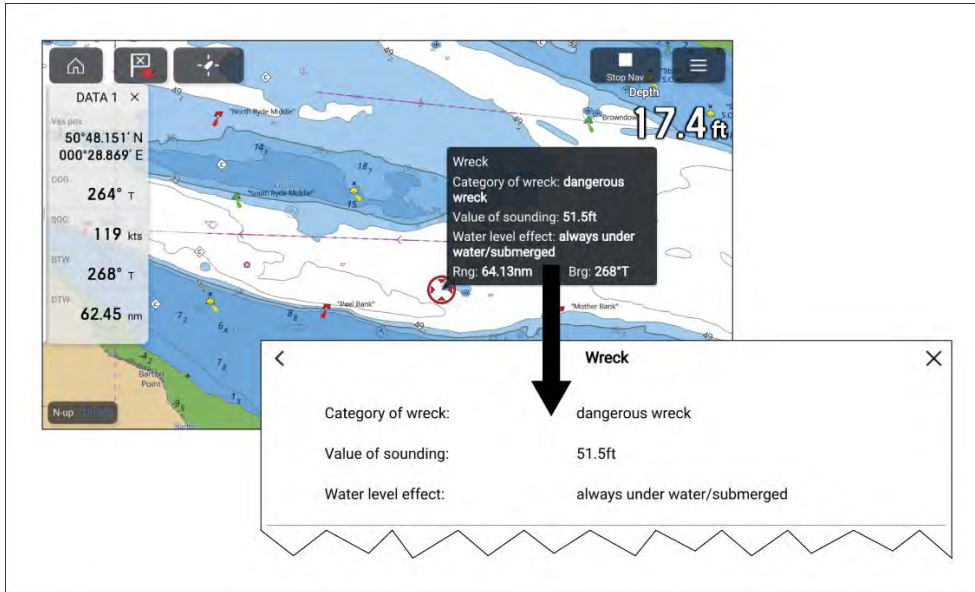

When an object is highlighted the cursor info box will be displayed which provides details about the object. Selecting the info box will show the object details on a fullscreen page.

The [Cursor info boxes] can be disabled from the [Advanced] settings menu: [Menu > Settings > Advanced > Cursor info boxes:].

Chart app - General

Full chart information

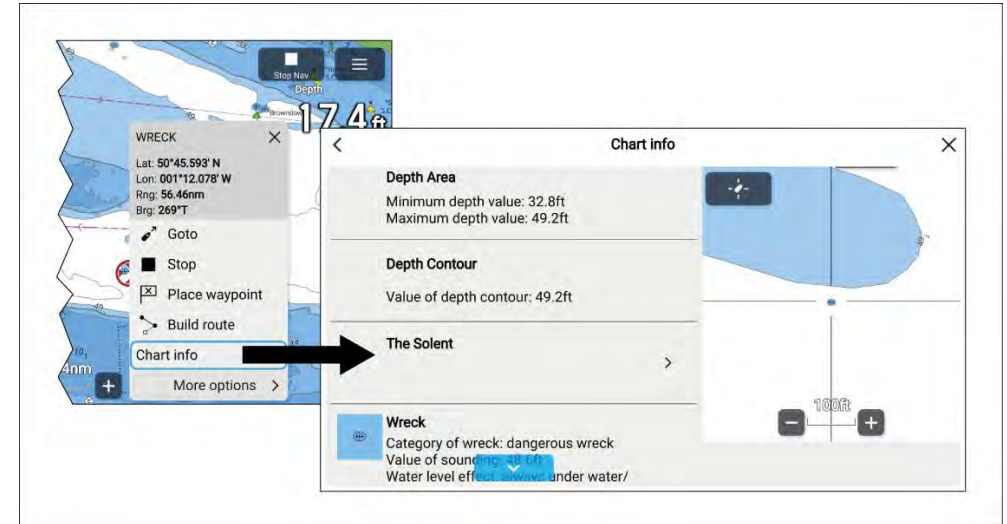

More detailed chart information can be viewed by selecting [Chart info] from the context menu. The detailed information can be viewed regardless of whether the [Chart info boxes] setting is enabled or disabled.

Chart layers

Layers (additional data and views) can be overlaid on the Chart app.

Some layers and views are dependent on connected hardware and cartography type and vendor.

13.3 Cartography overview

The Chart app includes a basic world base map. To use the Chart app for navigation purposes, compatible, detailed Electronic Navigational Charts (ENC) or Raster Navigational Charts (RNC) are required.

- **Raster Navigational Chart (RNC)** — A Raster chart is a digital image of a paper chart, and therefore the available information is limited to the information available on the equivalent paper chart.
- **Electronic Navigational Chart (ENC)** — ENCs are Vector based charts and include information that is not available on paper or Raster charts. Objects and features on Vector charts can be selected to obtain information that otherwise would not be readily available. Chart objects and features can also be enabled and disabled, or customized.

Note:

- The level of detail and features available on charts vary depending on vendor, chart type, subscription level and geographic region. Prior to purchasing charts, check the vendor's website to establish what level of detail is available on the charts you want to purchase.
- The information relating to available chart detail and settings in this manual should be treated as guidance only, as it is subject to change, which is not under Raymarine's control.

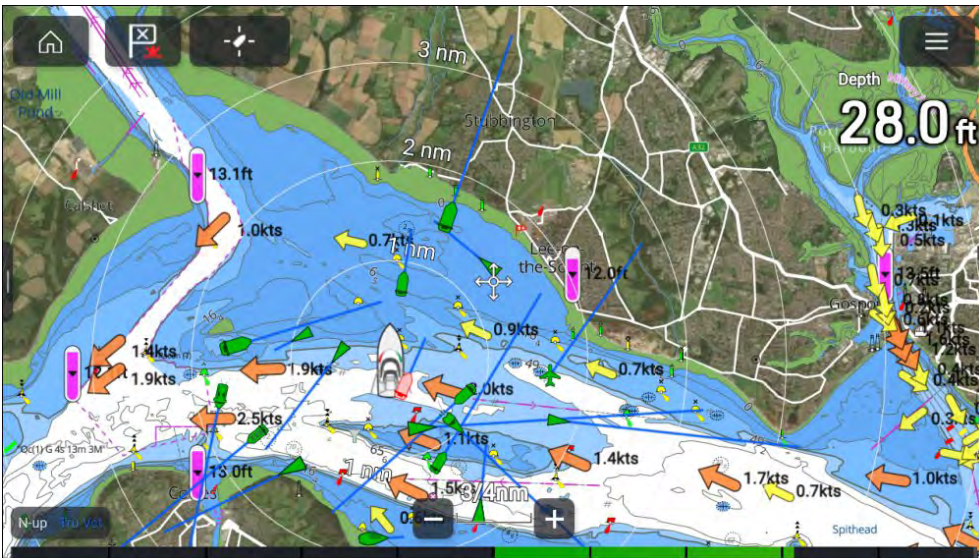

Layers can be enabled and disabled from the *[Layers]* settings menu: *[Menu > Settings > Layers]*.

For details of the available layers and related settings refer to: [p.244 — Layers settings menu](#)

Camera tracking

When connected to a compatible Pan and Tilt Thermal camera you can track targets or point your camera at a specific target or area.

2 options are available for camera tracking:

- *[Point camera here]*— Points the camera at a specific point onscreen, the camera will remain pointed at this area regardless of your own vessel's course.
- *[Track with camera]*— Tracks a selected target regardless of your own vessel's or target's course.

Camera tracking options are available from the Context menu in the Chart and Radar apps: *[Context menu > more options > Point camera here]*, or *[Context menu > more options > Track with camera]*.

Automatic tracking

You can use the Camera app settings to configure automatic tracking for AIS, Radar and MoB targets: *[Camera app > Menu > Settings > Camera motion > AUTO TRACKING]*

Supported cartography vendors

You MFD supports cartography from the vendors listed below.



1. Next generation LightHouse™ charts
2. Retired LightHouse™ vector, raster and NC2 charts
3. S-63 encrypted charts
4. Navionics charts
5. C-Map

Refer to the Raymarine website for the latest list of available LightHouse™ charts www.raymarine.com/marine-charts/

To check the currently supported Navionics charts please visit www.navionics.com or www.navionics.it

To check the currently supported C-MAP® chart please visit: www.c-map.com

Third-party raster charts

Raster navigational charts from the following third-party vendors are supported.

Note:

Raster charts are created by scanning paper charts; each segment of the paper chart is turned into a digital image. The detail available on raster charts is therefore limited to the detail on the paper chart it was created from. Raster charts do not offer the dynamic content that is typically available on vector-based electronic charts.

- **Standard mapping** — USA only.(For details, visit: <https://www.standard-map.com/>)
- **CMOR Mapping** — USA only.(For details, visit: <https://www.cmormapping.com/>)
- **Strike Lines Charts** — USA only.(For details, visit: <https://strikelines.com/>)

- **Imray** — (For details visit <https://www.imray.com/>)

Note:

For assistance using these charts, refer to the chart vendor.

End-User License Agreements (EULAs)

The EULAs for third-party electronic charts are available via the following links:

- **LightHouse charts:** — [LightHouse Navigation Charts EULA 84231-3-EN.pdf](#)
- **Navionics charts:** <https://www.navionics.com/usa/la>
- **C-MAP charts:** <https://www.c-map.com/legal/terms-and-conditions-eula>

Caution: Care of chart and memory cards

To avoid irreparable damage to and / or loss of data from chart and memory cards:

- Ensure that chart and memory cards are fitted the correct way around. DO NOT try to force a card into position.
- DO NOT use a metallic instrument such as a screwdriver or pliers to insert or remove a chart or memory card.
- Ensure correct memory card ejection procedure is carried out before removing the chart or memory card from the card reader.

13.4 LightHouse charts

LightHouse™ charts is the brand name for Raymarine's electronic navigation charts. LightHouse™ charts can include a Premium subscription, which adds new and enhanced features on a regular basis.

Note:

Legacy LightHouse™ Vector, Raster and NC2 charts have now been discontinued and can no longer be downloaded or updated.

New LightHouse™ charts come with a free 1 year subscription to LightHouse™ Premium. The Premium subscription unlocks data-rich points of interest (POI), high-resolution satellite aerial overlays and regular chart updates. After the free subscription period ends, the Premium features can be continued for an annual fee.

LightHouse™ charts can be purchased directly from the LightHouse™ Chart Store. Alternatively, they can be purchased from Raymarine dealers, as either a pre-loaded chart card or a blank chart card that includes a voucher that can be redeemed from the Chart Store.

To find out more about available regions and the latest features, visit the LightHouse™ Chart Store: <https://chartstore.raymarine.com/lighthouse-charts>

LightHouse Chart Store

LightHouse™ charts can be purchased from the LightHouse™ Chart Store, which can be accessed from a personal computer (PC) or from a mobile device via the Raymarine app.

You must have a Chart Store account and be logged in to the account before you can purchase charts in the Chart Store. This account can be created during the checkout process if required.

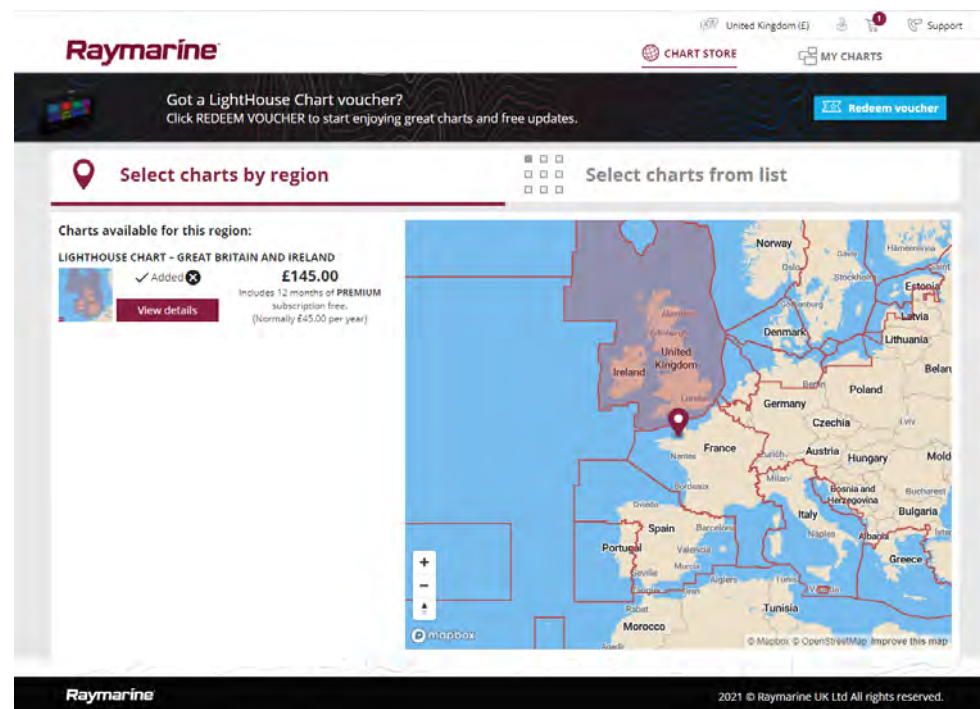

Pre-loaded LightHouse Chart Cards

LightHouse™ charts are also available pre-loaded on MicroSD cards. Simply insert the card into your MFD's card reader to start using.

Note:

New regions are added all the time, check with your local Raymarine dealer for the latest available regions.

- North America LightHouse™ preloaded chart card (part number: **R70794**).
- Australia/New Zealand LightHouse™ preloaded chart card (part number: **R70794-AUS / R70794-ANZ**).
- Denmark LightHouse™ preloaded chart card (part number: **R70794-DEN**).
- Finland LightHouse™ preloaded chart card (part number: **R70794-FIN**).
- France LightHouse™ preloaded chart card (part number: **R70794-FRA**).
- Germany LightHouse™ preloaded chart card (part number: **R70794-GER**).

The Chart Store can be accessed using the following link:
<https://chartstore.raymarine.com/lighthouse-charts>

- Greece LightHouse™ preloaded chart card (part number: **R70794–GRE**).
- Great Britain & Ireland LightHouse™ preloaded chart card (part number: **R70794–IGB**).
- Italy LightHouse™ preloaded chart card (part number: **R70794–ITA**).
- Netherlands LightHouse™ preloaded chart card (part number: **R70794–NED**).
- Norway LightHouse™ preloaded chart card (part number: **R70794–NOR**).
- Portugal LightHouse™ preloaded chart card (part number: **R70794–POR**).
- Spain LightHouse™ preloaded chart card (part number: **R70794–SPA**).
- Sweden LightHouse™ preloaded chart card (part number: **R70794–SWE**).
- Blank 32 GB MicroSD card for LightHouse™ Charts (part number: **R70838**).

Hybrid LightHouse charts

LightHouse™ version 4.1.75 and LightHouse™ Sport version 3.17 (for Element™) operating system updates include a new hybrid chart engine which provides improved performance for supported LightHouse™ charts. From September 2022 new LightHouse™ chart regions will start to be available which will include support for the new hybrid chart engine.

The following charts will include support for the hybrid chart engine:

- North America Region (part number: **R70794**).
- Western Europe region (part number: **R70794–WEU**).
- Northern Europe Region (part number: **R70794–NEU**).
- Mediterranean Region (part number: **R70794–MED**).
- France (part number: **R70794–FRA**).
- Australia/New Zealand (part number: **R70794–AUS / R70794–ANZ**).

Note:

New regions are added all the time, check with your local Raymarine dealer for the latest available regions.

Redeeming chart voucher

If you have purchased a download chart card with a voucher code then the voucher is redeemed from the LightHouse™ chart store.

1. Go to the LightHouse™ chart store: <https://chartstore.raymarine.com/light-house-charts>
2. Click *[Redeem]*.
3. Create a new account, or login to your existing account.
4. Enter your voucher code and click *[Submit]*.
5. Click *[View charts]* from the voucher accepted page.
6. Select the required region.
7. If your voucher entitles you to a second region click *[Pick 2nd chart]* and then select your second region.
8. Click *[Done]*.

Your selected region(s) will now be available in *[MY CHARTS]*.

Downloading charts from My Charts

Once redeemed charts can be downloaded from the MY Charts area of the LightHouse™ charts store.

1. Log in to your account.
2. Go to the *[MY CHARTS]* area.
3. Expand the Download options for the region(s) you want to download.
4. If updates are available click *[Get latest data]*.
5. If you have a valid Premium subscription add the *[Streets & POI]* and *[Aerial photos]* that you want to include.

When adding [Streets & Points of Interest] and [Aerial photos] you can create up to 5 area boxes for each feature per purchased region. Follow the onscreen instructions to define each area of coverage.

6. Click *[Download]*.
7. If you have more than 1 region you can group them together by selecting the relevant grouping option.

Grouping allows you to minimize download file size, by grouping up to 3 regions, from the same continent together.

8. Check the SD card requirements.

Important:

A blank chart card purchased from a Raymarine dealer will already be in the correct format.

9. Click *[CONTINUE]*.
10. Check unique ID file.

Important:

A blank chart card purchased from a Raymarine dealer will already include the unique ID file.

11. Click *[CONTINUE]*.
12. Check 'LightHouse_charts' folder

Important:

A blank chart card purchased from a Raymarine dealer will already include the 'LightHouse_charts' folder.

13. Click *[CONTINUE]*.
14. Click *[Browse to file]* and locate the Lighthouse_id.txt file in the root directory of the chart card.
15. Click *[CONTINUE]*.
The download package will now be prepared and downloaded to your computer.

Note:

- Depending on files size and connection speed the package preparation and download may take some time, click *[receive email notification]* to get an email when the package is ready to be downloaded.
- If the download does not start automatically once the package has been prepared click *[Download]*.

16. Locate the downloaded file and copy to the Lighthouse_charts folder on your SD card.

Important:

Ensure that the folder contains only 1 file.

17. The memory card can now be inserted into your MFD.

13.5 S-63 Encrypted Charts

S-63 is an International Hydrographic Organization (IHO) standard for encrypting, securing and compressing electronic navigational chart (ENC) data. When correctly configured with a valid S-63 MFD activation file, your MFD can utilize S-63 Encrypted Charts.

Advantages of using S-63 encrypted charts include:

- Assured authenticity of chart data.
- Regular updates.

For more information on S-63 Encrypted Charts, refer to: <https://iho.int/en/>

S-63 Encrypted Charts installation process

Unlike electronic cartography from other vendors, S-63 Encrypted Charts require you to complete an installation procedure.

Note:

The recommended installation process requires up to 3 memory cards, and your MFD requires more than one available card reader slot. For MFDs that have only one internal card reader slot, an external card reader such as the RCR-SDUSB or RCR-2 is required.

1. MFD hardware activation. Refer to: [p.207 – Obtaining an S-63 MFD activation file](#)
2. Copy user permit(s) file from MFD. Refer to: [p.208 – Copying user permit file\(s\) to memory card](#)
3. Purchase and download charts (requires user permit file). Refer to: [p.208 – Purchasing S-63 Encrypted Charts](#)

- Install base cell files and cell permits file. Refer to: [p.208 — Installing base cells and cell permits](#)
- Install Cumulative update files and if received, new cell permits file. Refer to: [p.209 — Installing cumulative updates](#)

Important:

- The memory card that the charts are installed on must be present in the MFD's card reader for the installed charts to be used.
- After installation, it is recommended that the memory cards containing the base cells and cumulative updates are kept onboard your vessel so that if the need arises they can be reinstalled easily.

Obtaining an S-63 MFD activation file

An S-63 MFD activation file must be installed on your MFD to display and enable the use of S-63 Encrypted Charts on your MFD. Without the S-63 MFD activation file installed S-63 chart selection and related settings will not be available.

Note:

An S-63 MFD activation file will be required for each MFD you want to be able to view S-63 encrypted charts on. S-63 encrypted charts are not shared with other MFD's on the same network.

- Identify your MFD's product name, product number and serial number.

The required information can be found on the [Getting started] settings menu and the Network settings menu:[Homescreen > Settings > Getting started.], [Homescreen > Settings > Network] or from the physical product label.

Example



- A** — Product name
- B** — Product number
- C** — Serial number

- Contact your Raymarine dealer or Raymarine technical support and supply them with the above information to obtain an S-63 MFD activation file. You will be sent an S-63 MFD activation file specific for your MFD.
- Copy the received file to a blank / empty MicroSD card.
- Insert the MicroSD card into the memory card reader slot of your MFD. After a few seconds the MFD will detect and install the file. A notification is displayed onscreen when the installation is completed successfully.

The MFD will now be able to select S-63 Encrypted Charts and display them in the Chart app. Related settings will also be available.

Scheme administrator certificate

S-63 Encrypted Charts require a valid scheme administrator (SA) certificate. A current SA certificate is provided with the LightHouse™ 3 and LightHouse™ 4 operating systems. Access to the SA certificate is provided when the S-63 MFD activation file is installed on your MFD.

The installed SA certificate is valid for a predetermined period of time after which it will expire. It is also possible for the IHO to issue a new certificate for security reasons.

When the SA Certificate expires an ‘SSE-22’ notification is displayed on your MFD and the SA certificate will require updating before you can update or buy new S-63 Encrypted Charts.

If the scheme administrator issues a new certificate then an ‘SSE-06’ notification is displayed on your MFD and the SA certificate will require updating before you can update or buy new S-63 Encrypted Charts.

Updated SA certificate can be obtained from the IHO website: <https://iho.int/en/>. Currently available on the following page: <https://iho.int/en/enc-data-protection>

You can replace the SA Certificate installed on your MFD from the SA certificate tab: *[Chart app > Menu > Settings > Cartography > S-63 Settings > SA security certificate > Update SA security certificate]*.

Copying user permit file(s) to memory card

When purchasing S–63 Encrypted Charts the vendor will require the user permit file(s) for the MFDs you want to use the charts on.

1. Insert a MicroSD card into your MFD’s card reader.
2. Open the *[Cartography]* settings tab in the Chart app: *[Chart app > Menu > Settings > Cartography]*.
3. Select *[S-63 Settings]*.
4. Select the *[User permit]* tab.
5. Select *[Save user permits to a file]*.
6. Select the card slot that you inserted the memory card into.
7. Select *[OK]* on the confirmation dialog.
8. Safely eject the memory card from your display using the Shortcuts page *[Eject SD card]* option.

The S-63 user permit file must be sent to the chart vendor during the purchase process.

Purchasing S-63 Encrypted Charts

The process below describes a typical purchasing procedure; however, each vendor’s process may differ slightly.

1. Create an account on the vendor’s website.
2. Login to the account.
3. Select the chart regions you wish to purchase.
4. Send your MFD’s user permits file to the chart vendor (this may be part of the checkout process).

5. Download the Cells permits file.
6. Download the Base cell file (this is typically a compressed ‘zip’ file).
7. Download the Cumulative update file (this is typically a compressed ‘zip’ file).

Important:

S-63 Encrypted Charts are locked to the MFD specified in the user permit file that you supplied to the chart vendor. If you have purchased charts for multiple MFDs (i.e. you supplied user permits to more than one MFD), you must ensure that you split the received cell permit files between the MFDs accordingly.

Installing base cells and cell permits

When purchasing S-63 Encrypted Charts for the first time and as part of regular updates base cells and cell permits require installation before they can be used. The base cell files contain the cartographic data and the cell permits are used to authorize the use of the base cell files.

Typically the base cell files and their related cell permits are updated twice a year.

Note:

- Base cell files and the cell permits file must be installed before any available cumulative update files.
- It is recommended that base cell files, cumulative update files and the resulting installed chart files are all stored on separate memory cards, e.g.:
 - Card 1 = Base cell files and the cell permits file.
 - Card 2 = Cumulative update files and if applicable the cell permits file.
 - Card 3 = Installed charts (location that base cell files, cell permits file and cumulative update files are installed).

Note:

If you receive 'SSE' messages during the base cell installation, proceed with the cumulative update installation and this should resolve the errors. If errors persist after the cumulative update installation contact Raymarine product support for resolution..

1. Unzip the downloaded base cell file, using the 'Extract all' option of your PC's zip file application.

This ensures that the base cell files are created within a folder named the same as the original zip file.

2. Copy the folder and all contents to the root directory of your memory card.
3. Copy the received cell permits file to the root directory of the same memory card.
4. Insert the memory card into your MFD's card reader.
5. Open the Chart app's [Cartography] selection tab: [Chart app > Menu > Settings > Cartography].
6. Select [Update S-63 charts].
7. Select the card reader that contains the base cell files and cell permits file.

The card will be scanned for valid files and permits, this process can take some time. Once complete a list of available chart cells is displayed.

8. Select [Select all], or select individual cells.
9. Select [Update selected charts] to install all base cells.
10. Select the card reader slot where you want the files to be installed.

Important:

The same 'Installed charts' card and memory card slot MUST be used to install and update base cell files and cumulative update files.

11. Wait for the installation to complete.

A progress bar is displayed as the base cells are installed.

12. Select [OK] on the successfully imported notification.

Note:

The installation process will create and store chart data in 2 folders on your memory card: 'senc' and 'seapilot', Overwriting, deleting or altering these folders or data within them will render your charts inoperable.

Installing cumulative updates

When purchasing S-63 Encrypted Charts for the first time and as part of regular updates any available cumulative updates require installation. The cumulative update files contain updated cartographic data.

Typically cumulative update files are made available fortnightly on the vendor's web server.

Note:

- Cumulative update files should be installed after the installation of base cell files.
- If a new cell permits file is received, this must be installed with the cumulative update.
- It is recommended that base cell files, cumulative update files and the resulting installed chart files are all stored on separate memory cards, e.g.:
 - Card 1 = Base cell and the cell permits file.
 - Card 2 = Cumulative update files and if applicable the new cell permits file.
 - Card 3 = Installed charts (location that base cell files, cell permits file and cumulative update files are installed).

Important:

If your chart vendor does not supply cumulative update files then updates must be installed separately and in release date order.

1. Unzip the downloaded cumulative update file, using the 'Extract all' option of your PC's zip file application.

This ensures that the cumulative update files are created within a folder named the same as the original zip file.

2. Copy the folder and all contents to the root directory of your memory card.
3. If required, copy the new cell permits file to the root directory of the same memory card.
4. Insert the memory card into your MFD's card reader.
5. Open the Chart app's [Cartography] selection tab: [Chart app > Menu > Settings > Cartography].
6. Select [Update S-63 charts].
7. Select the card reader that contains the cumulative update files and if applicable, the new cell permits file.

The card will be scanned for updates, this process can take some time. Once complete the list of installed base cells is displayed and any cells that have updates available will be automatically selected.

8. Select [Update selected charts] to install all base cells.
9. Select the card reader slot where you want the files to be installed.

Important:

The same 'Installed charts' card and memory card slot MUST be used to install and update base cell files and cumulative update files.

10. Wait for the installation to complete.

A progress bar is displayed as the base cells are installed.

11. Select [OK] on the successfully imported notification.

Note:

The installation process will create and store chart data in 2 folders on your 'Installed charts' memory card: 'senc' and 'seapilot'. Overwriting, deleting or altering these folders or data within them will render your charts inoperable.

Note:

If errors persist after the installation of cumulative update files contact Raymarine product support for resolution..



Warning: Expired S-63 Encrypted Charts

S-63 Encrypted Chart cells expire after a set period of time. Once expired the charts must not be used for navigation. You will be notified onscreen of the expiration. The charts must be updated before they can be used for navigation.

S-63 Encrypted Chart settings

With the S-63 MFD activation file installed the S-63 Encrypted Charts related settings are available on the Cartography settings tab.

- [Update S-63 charts]— This option is used to decrypt your purchased S-63 Encrypted Chart data so that they can be displayed on the MFD.
- [View installed S-63 charts]— View a table of all currently installed chart cells
- [S-63 settings]— Access the following S-63 related settings:
 - [SD card]— Choose external storage location used for the Installed charts.
 - [User permit]— View and save user permits to file,
 - [SA security certificate]— View and update installed SA certificate.

13.6 Navigation



Warning: Maintain a permanent watch

Always maintain a permanent watch, this will allow you to respond to situations as they develop. Failure to maintain a permanent watch puts yourself, your vessel and others at serious risk of harm.



Warning: Autopilot usage

Autopilots navigate a preset course and do NOT respond to hazards automatically. The operator must remain at the helm at all times and be ready to avoid hazards and warn passengers of course changes.

Cross Track Error (XTE)

Cross Track Error (XTE) occurs when your vessel is steered or drifts off its intended course. The distance between your intended course and your actual position is the Cross track error (XTE).

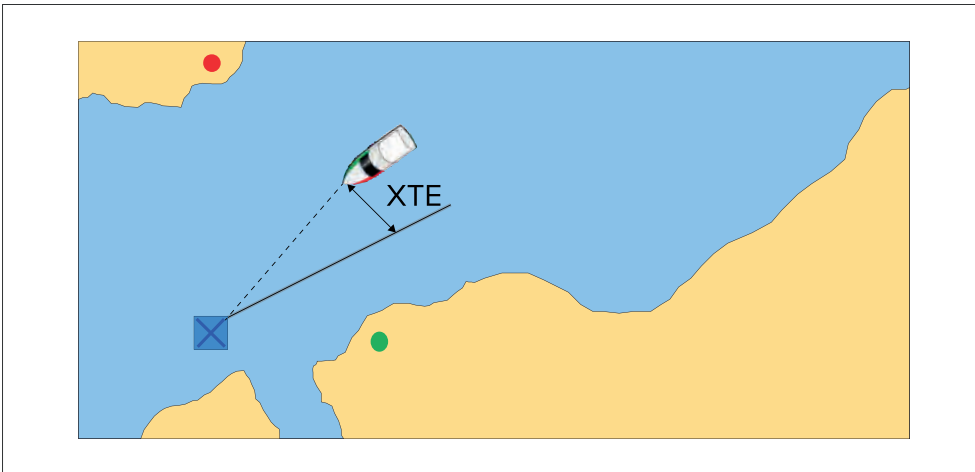

The *[Off track]* alarm can be used to warn you if your vessel reaches a specified distance from your intended course. The Off track alarm can be configured from the Alarms manager: *[Homescreen > Alarms > Off track]*.

When a cross track error exists you can either steer your vessel back on to its intended course or you can use the *[Restart XTE]* option to zero the XTE value and use a new course from your current position as the intended course.

Select *[Restart XTE]* from the Navigation menu: *[Menu > Navigation > Restart XTE]* to restart your XTE..

Navigating to a waypoint or point of interest (manual steering)

You can navigate to a waypoint or a point of interest by performing a *[Goto]*. When performing a *[Goto]* active navigation will commence which guides you to a selected destination.

Follow the steps below to perform a *[Goto]* using manual steering:

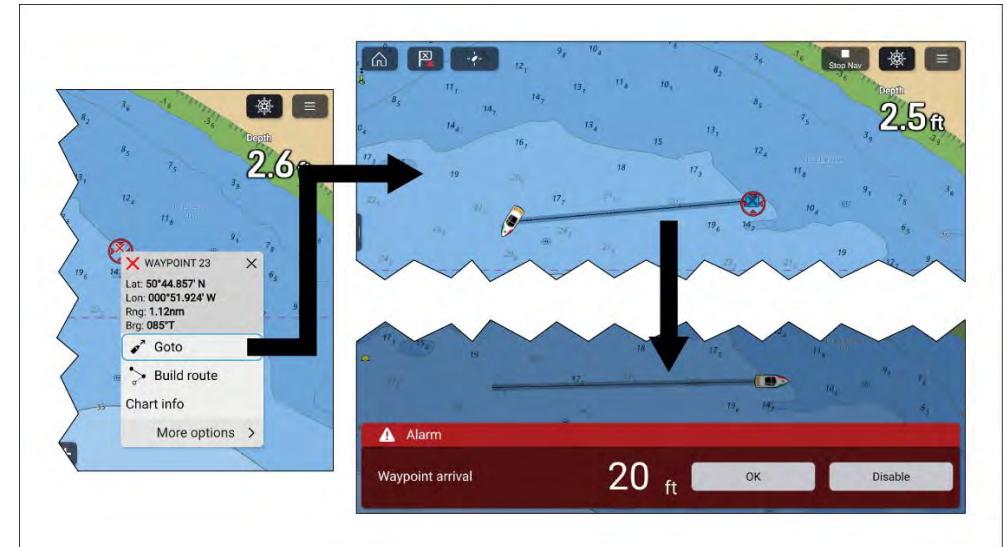

1. Select and hold on the waypoint or point of interest and select *[Goto]* from the context menu.
2. Manually navigate to the selected destination.
3. The waypoint arrival alarm will trigger when your vessel reaches the waypoint arrival radius.

The Waypoint arrival radius can be set from the Alarms manager: [Homescreen > Alarms > Settings > Arrival radius].

If the Waypoint arrival alarm is disabled then no notification will be triggered.

4. Select *[OK]* on the waypoint arrival notification.
5. Select the *[Stop Nav]* onscreen icon located at the top of the screen or select *[Stop]* from the context menu or *[Navigation]* menu to end active navigation.

You can also navigate to a waypoint from the *[Go]* menu: *[Menu > Go > Waypoint]* or you can navigate to a specified latitude and longitude from the *[Go]* menu: *[Menu > Go > Lat/long]*.

You can end active navigation at any time by selecting the *[Stop Nav]* onscreen icon located at the top of the screen or selecting *[Stop]* from the context menu or *[Navigation]* menu.

For more information on waypoints and waypoint management refer to: [11.1 Waypoints](#)

Navigating to a waypoint or point of interest (autopilot)

You can navigate to a waypoint or a point of interest by performing a *[Goto]*. When autopilot integration is enabled, performing a *[Goto]* will commence active navigation which will guide you to a selected destination and controls will be available to engage your autopilot.

Follow the steps below to perform a *[Goto]* using autopilot steering:

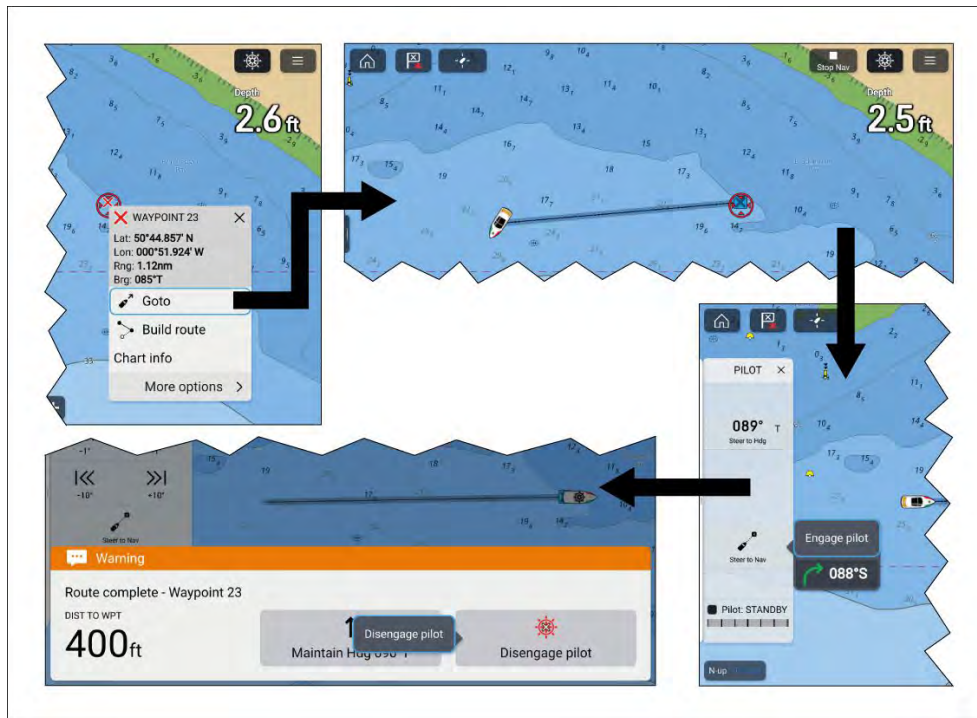

1. Select and hold on the waypoint or point of interest and select *[Goto]* from the context menu.

2. If required, engage the mechanical drive by either engaging the wheel drive's clutch or attaching the pushrod onto the tiller pin.
3. Select the *[Pilot]* icon located at the top of the screen.
4. Select *[Steer to Nav]* from the Pilot sidebar.
5. Select *[Engage pilot]*.
Your vessel will turn and navigate to the selected point.
6. The waypoint arrival alarm will trigger when your vessel reaches the Waypoint arrival radius (pilot in track mode).

The waypoint [Arrival radius (pilot in track mode)] can be set from the Alarms manager: [Homescreen > Alarms > Settings > Arrival radius (pilot in track mode)]. The [Arrival radius (pilot in track mode)] overrides the standard [Arrival radius] notification.

7. Select *[Disengage pilot]* from the notification and then *[Disengage pilot]* from the pop-over.
8. Alternatively, select *[Maintain Hdg]* from the notification and then *[Engage pilot]* from the pop-over to maintain a locked heading on the current course.
9. Select the *[Stop Nav]* onscreen icon located at the top of the screen or select *[Stop]* from the context menu or *[Navigation]* menu to end active navigation.

You can end active navigation at any time by selecting the *[Stop Nav]* onscreen icon located at the top of the screen or selecting *[Stop]* from the context menu or *[Navigation]* menu.

For more information on waypoints and waypoint management refer to: [11.1 Waypoints](#)

Following a Route (manual steering)

Once a route is created or imported it can be navigated by performing a *[Follow route]*. When performing a *[Follow route]* active navigation will commence which guides you through each route leg to the route's final waypoint.

Important:

It is the captain's responsibility to ensure a route is safe to navigate before commencing the follow.

Follow the steps below to perform a *[Follow route]* using manual steering:

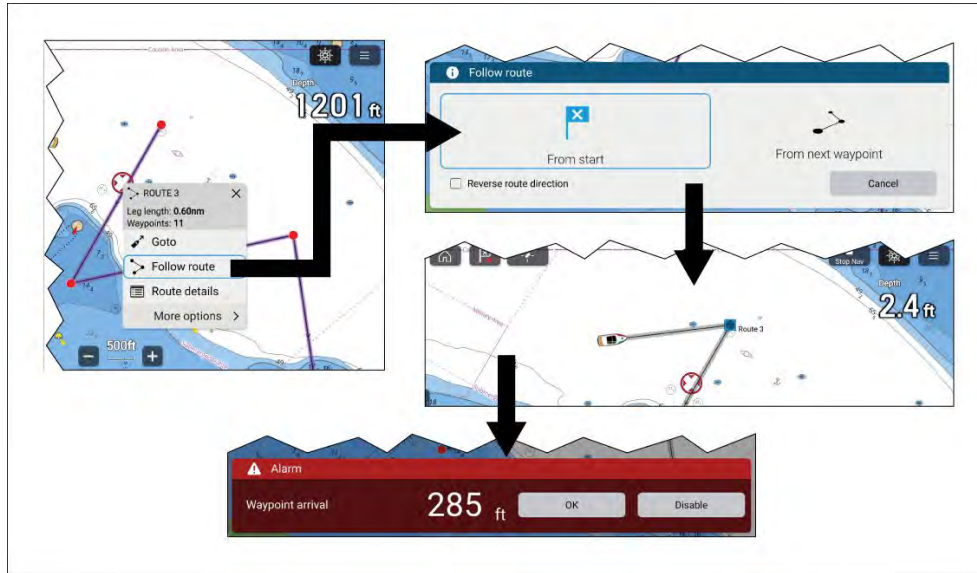

1. Select and hold on any route leg (the line drawn between the each of the route's waypoints).
2. Select *[Follow Route]* from the context menu.

*You can also select one of the route waypoints and select *[more options]* and then *[Follow route]*.*

Note:

If you select the first waypoint in a route then the next step is skipped and active navigation commences immediately.

3. Select the desired follow option from the Follow route notification:
 - Select *[From Start]* to commence active navigation from the first waypoint in the route.
 - Select *[From next waypoint]* to commence active navigation from the next waypoint after the selected route leg.

- Select *[From this waypoint]* to commence active navigation from the selected waypoint.

Note:

- The *[Reverse route direction]* option allows you to permanently reverse the route (i.e.: switch the start and end waypoint) so that the route can be followed in the opposite direction. To reverse the route select the check box and then choose either the desired options to commence active navigation.
- If the selected waypoint is part of more than 1 route then the Route list will be displayed so that you can choose which route you want to follow.

4. Manually navigate the route leg to the indicated waypoint.
5. The waypoint arrival will trigger when your vessel reaches the waypoint arrival radius.

*The Waypoint arrival radius can be set from the Alarms manager: *[Homescreen > Alarms > Settings > Arrival radius]*.*

If the Waypoint arrival alarm is disabled then no notification will be triggered.

6. Select *[OK]* to begin active navigation to the next waypoint in the route.
7. Follow steps 4, 5 and 6 above for all waypoint in the route.
8. Select the *[Stop Nav]* onscreen icon located at the top of the screen or select *[Stop]* from the context menu or *[Navigation]* menu to end active navigation.

You can end active navigation at any time by selecting the *[Stop Nav]* onscreen icon located at the top of the screen or selecting *[Stop]* from the context menu or *[Navigation]* menu.

For more information on routes and route management refer to: [11.2 Routes](#)

Following a Route (autopilot)

Once a route is created or imported it can be navigated by performing a *[Follow route]*. When autopilot integration is enabled, performing a follow route will commence active navigation which guides you through each route leg to the route's final waypoint. Options will also be available to control your autopilot.

Important:

It is the captain's responsibility to ensure a route is safe to navigate before commencing the follow.

Follow the steps below to perform a *[Follow route]* using autopilot steering:

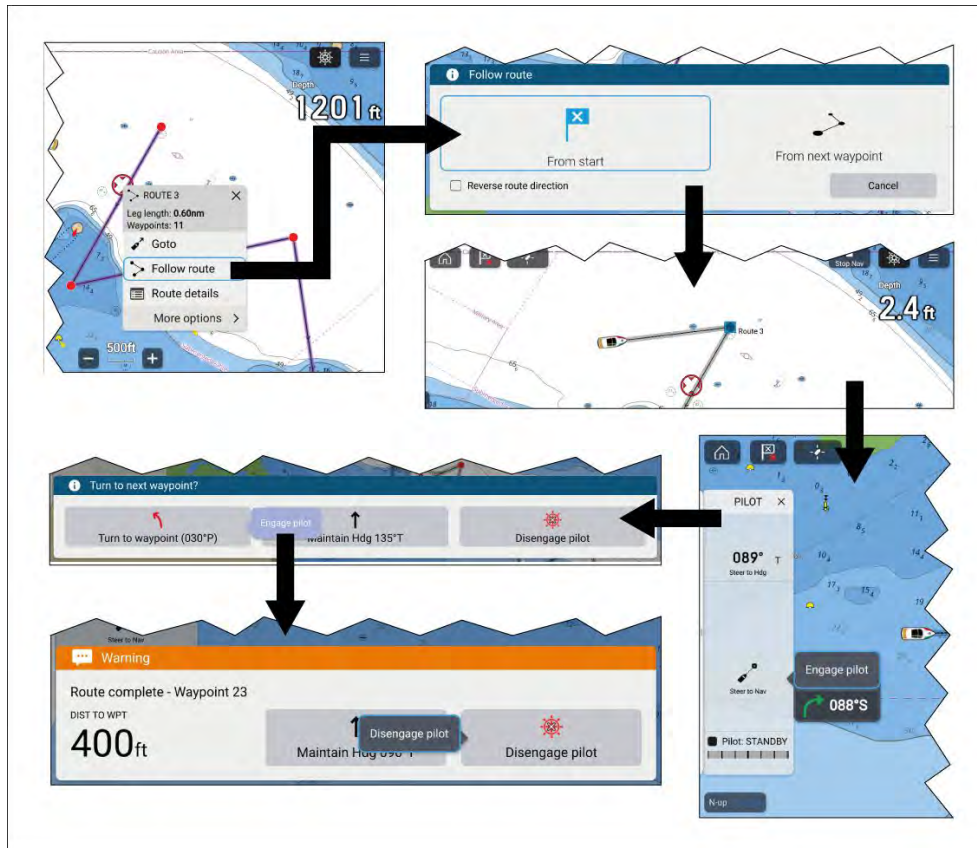

1. Select and hold on any route leg (the line drawn between each of the route's waypoints).
2. Select *[Follow Route]* from the context menu.

*You can also select one of the route's waypoints and select *[more options]* and then *[Follow route]*.*

Note:

If you select the first waypoint in a route then the next step is skipped and active navigation commences immediately.

3. Select the desired follow option from the Follow route notification:
 - Select *[From Start]* to commence active navigation from the first waypoint in the route.
 - Select *[From next waypoint]* to commence active navigation from the next waypoint after the selected route leg.
 - Select *[From this waypoint]* to commence active navigation from the selected waypoint.

Note:

- The *[Reverse route direction]* option allows you to permanently reverse the route (i.e.: switch the start and end waypoint) so that the route can be followed in the opposite direction. To reverse the route select the check box and then choose either the desired options to commence active navigation.
- If the selected waypoint is part of more than 1 route then the Route list will be displayed so that you can choose which route you want to follow.

4. If required, engage the mechanical drive by either engaging the wheel drive's clutch or attaching the pushrod onto the tiller pin.
5. Select the *[Pilot]* icon located at the top of the screen.
6. Select *[Steer to Nav]* from the Pilot sidebar.
7. Select *[Engage pilot]*.
Your vessel will turn and navigate to the indicated waypoint.
8. The waypoint arrival alarm will trigger when your vessel reaches the Waypoint arrival radius (pilot in track mode).

The waypoint [Arrival radius (pilot in track mode)] can be set from the Alarms manager: [Homescreen > Alarms > Settings > Arrival radius (pilot in track mode)]. The [Arrival radius (pilot in track mode)] overrides the standard [Arrival radius] notification.

9. Select [Turn to waypoint] to begin active navigation to the next waypoint in the route.
10. Follow steps 8 and 9 above until you reach the last waypoint in the route.
11. Select [Disengage pilot] from the notification and then [Disengage pilot] from the pop-over.
12. Alternatively, select [Maintain Hdg] from the notification and then [Engage pilot] from the pop-over to maintain a locked heading on the current course.
13. Select the [Stop Nav] onscreen icon located at the top of the screen or select [Stop] from the context menu or [Navigation] menu to end active navigation.

You can end active navigation at any time by selecting the [Stop Nav] onscreen icon located at the top of the screen or selecting [Stop] from the context menu or [Navigation] menu.

For more information on routes and route management refer to: [11.2 Routes](#)

Automatic turning

Automatic turning enables Evolution™ autopilots to automatically turn to the next waypoint in a route. When the current waypoint arrival radius has been reached a countdown will commence, and when it reaches zero the vessel will automatically turn toward the next waypoint.

The Automatic turning feature requires your Evolution autopilot to be running software version 3.14 or later.

Note:

Waypoints must be farther apart than the [Arrival radius (pilot in track mode)] distance.

Automatic turning is disabled by default. Automatic turning can be enabled and configured from the [Autopilot] settings menu: [Homescreen > Settings > Autopilot > Automatically turn to next waypoint].

During active navigation, Automatic turning can also be enabled and disabled from the [Navigation] menu: [Menu > Navigation > Auto. turn].

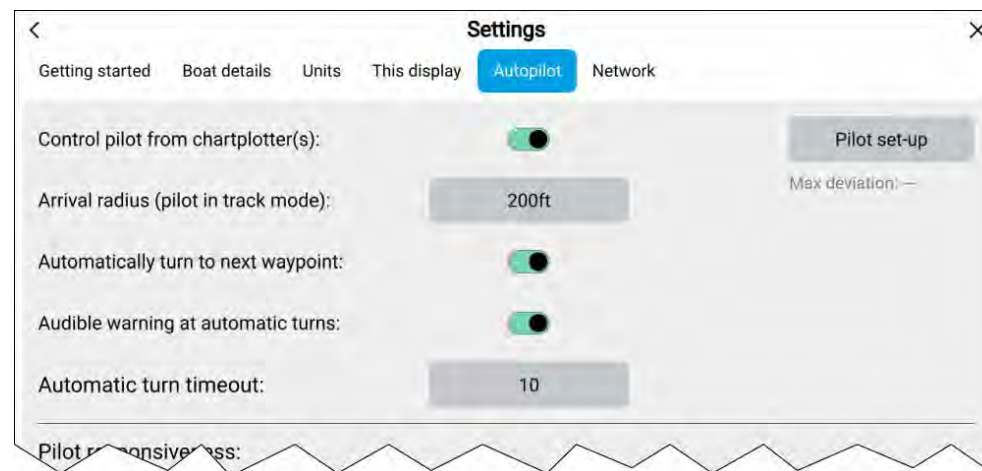

Configuration

- [Arrival radius (pilot in track mode)]— The automatic *turning to waypoint* notification is displayed when your vessel reaches the specified distance from the current active waypoint.
- [Automatically turn to next waypoint]— When this option is enabled, your vessel automatically turns to the next waypoint in a route.
- [Audible warning at automatic-turns]— When this option is enabled, the MFD will sound an audible beep as the countdown reaches zero.
- [Automatic turn timeout]— Determines the length of the countdown timer.

If the waypoint arrival alarm is enabled, the Automatic *turning to waypoint* notification is used.

Automatic turning to waypoint notification example

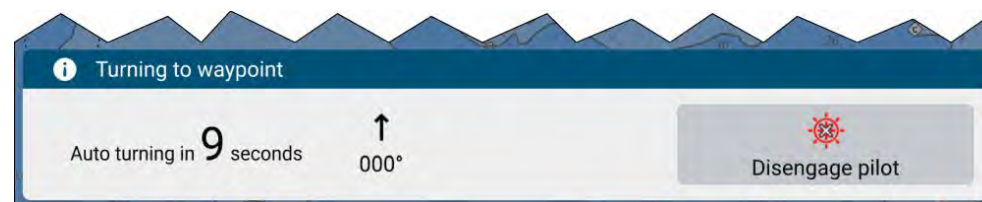

Select [Disengage pilot] from the *turning to waypoint* notification to disengage the autopilot and prevent the vessel from automatically turning.

If the waypoint arrival alarm is disabled, the brief *automatic turning* notification is displayed instead of the *full turning to waypoint* notification.

Automatic turning notification example



To prevent the vessel from automatically turning, select *[Disengage pilot]*.

Automatic turning limits exceeded

When following a route using automatic turning, route waypoints must be spaced farther apart than the distance specified in the waypoint *[Arrival radius (pilot in track mode)]* alarm. If the next waypoint in a route is present within the arrival radius, the *Exceeding recommended automatic turn limit* warning is displayed.

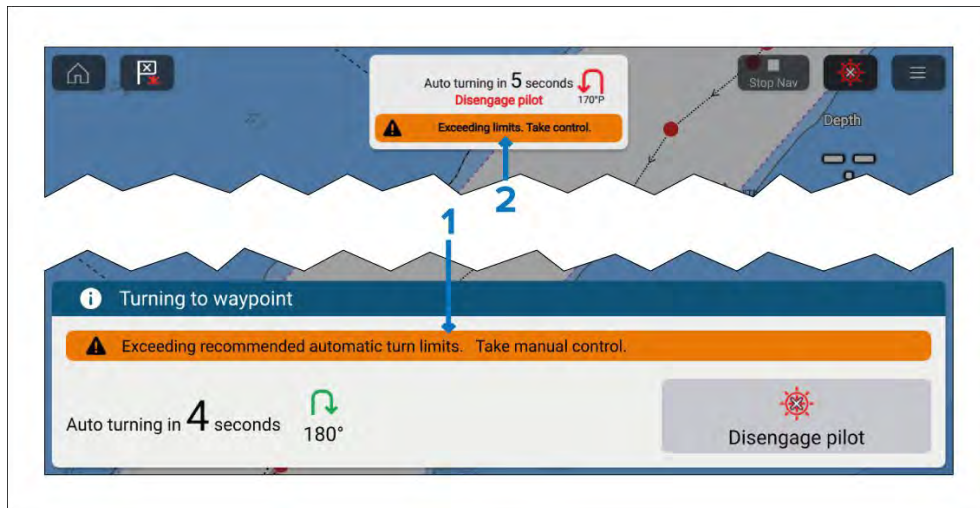

1. Warning within the *Automatic turning to waypoint* notification.
2. Warning within the *Automatic turning* notification.

For further details on route waypoint spacing, refer to: [p.159 — Route waypoint spacing](#)

Following a Route using automatic turning

Once a route is created or imported it can be navigated by performing a *[Follow route]*. When autopilot integration and automatic turning are enabled, performing a follow route will provide the option to engage the autopilot and commence active navigation which will guide you through each route leg and turn the vessel automatically when each waypoint is reached.

Important:

It is the captain's responsibility to ensure a route is safe to navigate before commencing the follow.

Follow the steps below to perform a *[Follow route]* using automatic turning.

Important:

When the warning is displayed you should take manual control of your vessel to navigate the route, otherwise waypoints in the route that are too close together will be skipped.

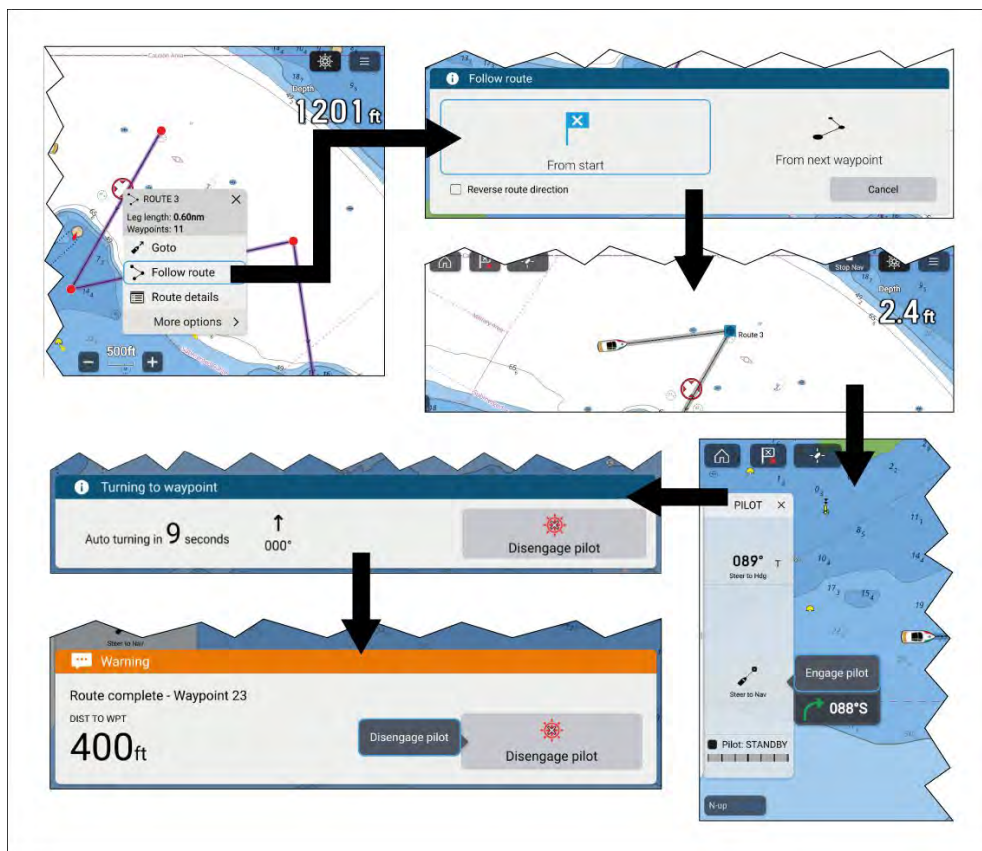

1. Select and hold on any route leg (the line drawn between the each of the route's waypoints).
2. Select *[Follow Route]* from the context menu.

*You can also select one of the route's waypoints and select *[more options]* and then *[Follow route]*.*

Note:

If you select the first waypoint in a route then the next step is skipped and active navigation commences immediately.

3. Select the desired follow option from the Follow route notification:
 - Select *[From Start]* to commence active navigation from the first waypoint in the route.

- Select *[From next waypoint]* to commence active navigation from the next waypoint after the selected route leg.
- Select *[From this waypoint]* to commence active navigation from the selected waypoint.

Note:

- The *[Reverse route direction]* option allows you to permanently reverse the route (i.e.: switch the start and end waypoint) so that the route can be followed in the opposite direction. To reverse the route select the check box and then choose either the desired options to commence active navigation.
- If the selected waypoint is part of more than 1 route then the Route list will be displayed so that you can choose which route you want to follow.

4. If required, engage the mechanical drive by either engaging the wheel drive's clutch or attaching the pushrod onto the tiller pin.
5. Select the *[Pilot]* icon located at the top of the screen.
6. Select *[Steer to Nav]* from the Pilot sidebar.
7. Select *[Engage pilot]*.
Your vessel will turn and navigate to the indicated waypoint.
8. The waypoint arrival alarm will trigger when your vessel reaches the Waypoint arrival radius (pilot in track mode) and a countdown will commence.

*If the *[Waypoint arrival]* alarm is disabled then the *Auto turn toast notification* is displayed instead of the *Auto turn waypoint arrival notification*.*

*The waypoint *[Arrival radius (pilot in track mode)]* can be set from the *Alarms manager*: *[Homescreen > Alarms > Settings > Arrival radius (pilot in track mode)]*. The *[Arrival radius (pilot in track mode)]* overrides the standard *[Arrival radius]* notification.*

Important:

When the auto turn countdown reaches zero your vessel will automatically turn towards the next waypoint. NO user action or confirmation is required.

9. Repeat step 8 until the last waypoint in the route is reached.

10. Select *[Disengage pilot]* from the notification.
11. Select the *[Stop Nav]* onscreen icon located at the top of the screen or select *[Stop]* from the context menu or *[Navigation]* menu to end active navigation.

You can end active navigation at any time by selecting the *[Stop Nav]* onscreen icon located at the top of the screen or selecting *[Stop]* from the context menu or *[Navigation]* menu.

For more information on routes and route management refer to: [11.2 Routes](#)

13.7 Rudder bar indicator

The rudder bar indicator is used to show a graphical representation of rudder angle that can be displayed at the bottom of the screen in the chart app. The rudder bar indicator is available in Navigate, Racing, Anchor and Fishing chart modes.

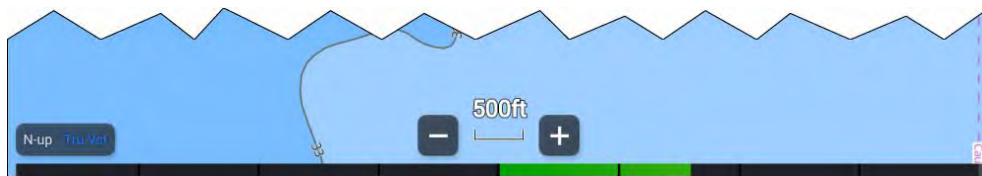

The rudder bar indicator requires rudder angle data to be transmitted to the display using NMEA 2000 PGN 127245.

The rudder bar indicator is enabled and disabled from the Layers chart menu: *[Menu] [[Layers] [[Rudder bar]*.

The rudder bar is disabled by default and must be enabled individually for each chart mode and Chart app page instance.

The Wind shift bar and Rudder bar cannot be displayed at the same time. When one is enabled the other will be disabled.

13.8 Depths and contours

Depth soundings

Water depth measurements displayed on charts are called Depth soundings.

Usually Depth soundings are shown using major and minor units, with minor units being smaller and subscript e.g.: Depending on units of measure '1₅' would mean 1.5 metres, 1 Fathom and 5 feet or 1.5 feet.

Raster charts

On Raster charts the units of measure the used for Depth soundings is fixed. The display of Depth soundings is also fixed and will only change depending on Chart app range scale.

Vector charts

On Vector charts Depth soundings will use the units of measure specified for depth in the MFD's settings: *[Homescreen > Settings > Units > Depth units:]*.

Depth sounding values appear differently onscreen:

Example LightHouse™ Charts Depth soundings

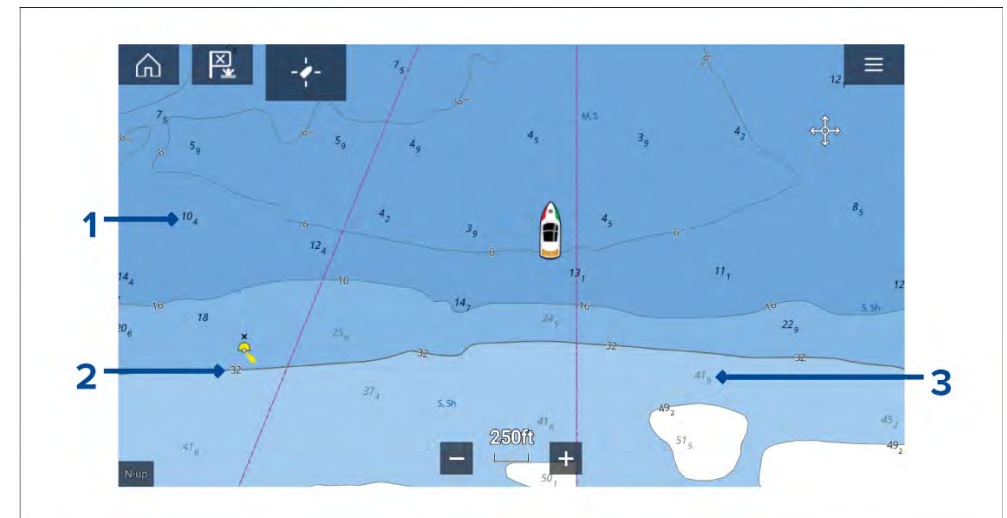

1. **Bold depth soundings** — Depth soundings displayed in Bold reflect depths shallower than the specified Safety contour depth.

2. White outlined depth soundings — Depth soundings displayed with a white ('Halo') outline reflect depths that are the same as the Safety contour depth.
3. Gray depth soundings — Depth soundings displayed in Gray reflect depths deeper than the specified Safety contour depth.

On Vector charts Depth soundings can be customized from the *[Depths]* settings menu: *[Menu > Settings > Depths > Show soundings.]*

The following Depth soundings options are available:

- *[None]* — No Depth soundings are displayed unless they are linked to a depth contour.
- *[Manual]* — Depth soundings are only shown from zero to the depth specified in the *[Zero to:]* option.
- *[All]* — All Depth soundings are displayed.

When *[Show soundings]* is set to *[All]* all depth soundings will be displayed.

Depth contours

Depth contours, also known as bathymetric contours or depth curves, are lines drawn on cartography that connect points of equal depth creating a visualization of underwater bottom structure. Contours use color fills to indicate depth in relation to other contours.

Raster charts

On Raster charts, depth contours are fixed and are always displayed.

Vector charts

On Vector charts, depth contours can be customized from the *[Depths]* settings menu: *[Menu > Settings > Depths > Show contours.]*

Depth contours include Depth soundings. The Depth contour soundings are differentiated from other Depth soundings by using a white outline.

The following Depth contour options are available:

- *[None]* — No Depth contour lines or depth contour soundings are displayed.
- *[Manual]* — Depth contours are only shown from zero to the depth specified in the *[Zero to:]* option.
- *[All]* — All Depth contours are displayed.

Note:

The Depth contours option does not affect the contour fill color.

Example LightHouse™ Charts Depth contours

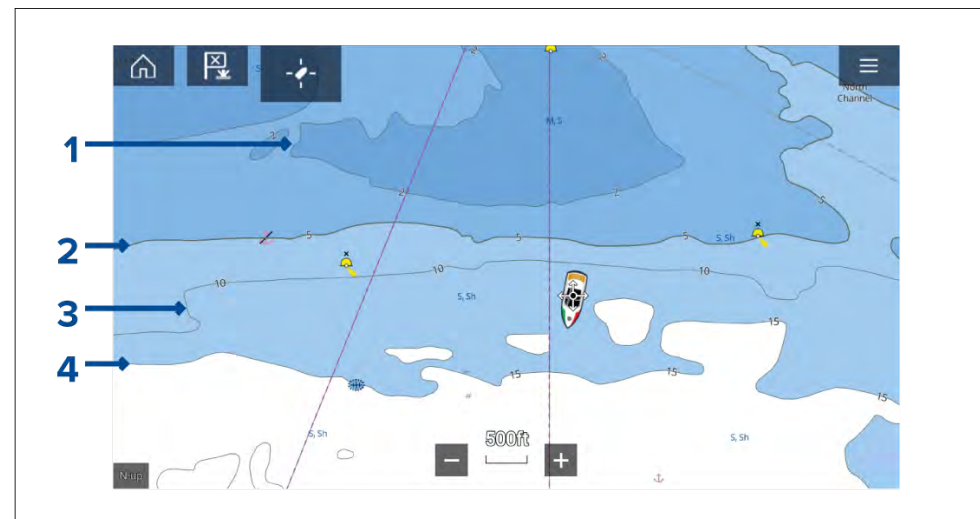

1. **Shallow contour** — Depths from zero to the depth specified in the *[Shallow contour]* setting will be within the Shallow contour. By default, the Shallow contour uses the darkest shade of blue.
2. **Safety contour** — Depths from the *[Shallow contour]* to the depth specified in the *[Safety contour]* setting will be within the Safety contour. The Safety contour uses a thicker line than other contour lines and is colored using a medium shade of blue.

Important: The Safety contour should be set to the same value as your vessel's *[Minimum safe depth]* and should be used to identify areas where you should not take your vessel.

3. **Depth contour** — All Depth contours consist of a line and depth soundings that appear along the line.
4. **Deep contour** — Depths from the *[Safety contour]* to the depth specified in the *[Deep contour]* setting will be within the Deep contour. By default, the Deep contour uses the lightest shade of blue. By default, depths greater than the Deep contour will be colored white.

Shallow contour, Safety contour and Deep contour values can be customized from the *[Depths]* settings menu: *[Menu > Settings > Depths]*.

Depth gradient

By default, the color gradient used for depth contours is *[Dark to Light]*, as described in the example above. If required, the *[Depth gradient]* can be changed to *[Light to Dark]*, which will invert the colors so that white is used for the Shallow contour, and the darkest shade of blue is used for depths deeper than the Deep contour value.

The Depth gradient can be changed from the *[Depths]* settings menu: *[Menu > Settings > Depths]*.

Note:

Charts from different cartography vendors will handle depth contours differently.

Navionics depth contours

When using Navionics® charts depth contours are automatically colored using a blue color gradient with the shallowest contour using the darkest shade and the deepest using white.

Example Navionics® Charts Depth contours

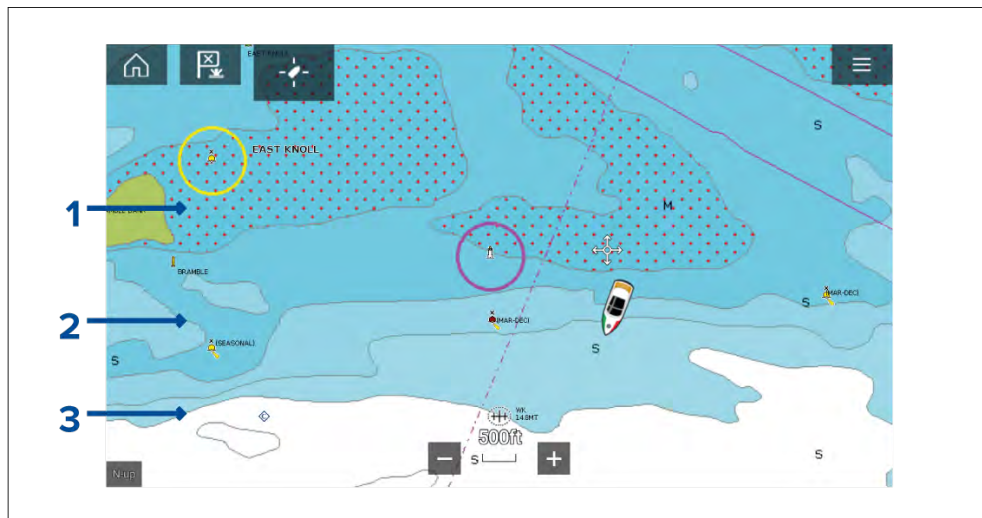

1. **Shallow area** — When the *[Shallow area]* feature is enabled all depths from zero to the depth specified in the *[Zero to:]* setting will use red cross hatching to identify shallow areas.
2. **Depth contour** — All depth contours are identified using a line and a blue color fill gradient.
3. **Deep contour** — All depths deeper than the depth specified in the *[Deep contour:]* setting is colored white by default.

Deep water color

The color used for the Deep contour can be set to either white or blue. When set to blue the Deep water contour will use the lightest shade of blue.

The depth contour settings can be accessed -from the *[Depths]* settings menu: *[Menu > Settings > Depths]*.

C-MAP depth contours

When using C-MAP® charts depth contours are automatically colored using a blue color gradient with the shallowest contour using the darkest shade and the deepest using white.

Example C-MAP® Charts Depth contours

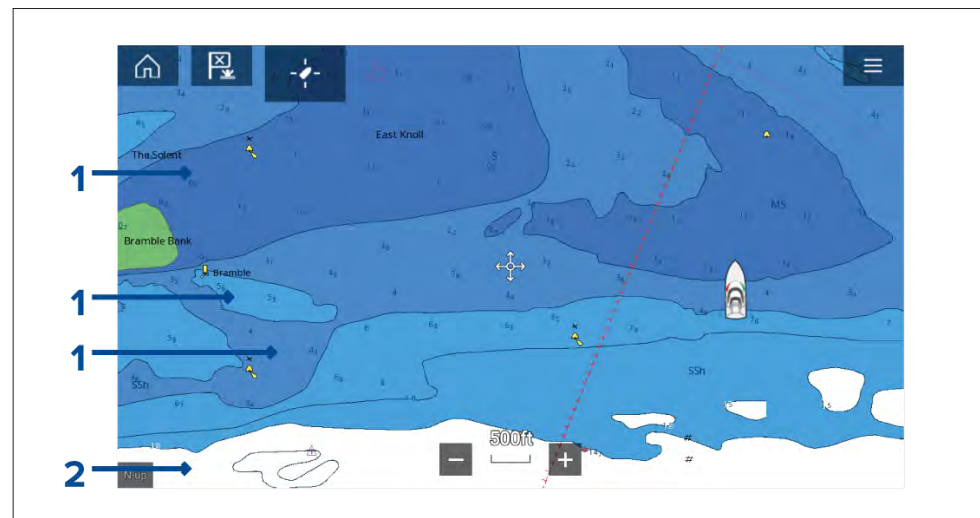

1. **Depth contours** — All depth contours are identified using a line and a blue color fill.
2. **Deep contour** — All depths deeper than the depth specified in the *[Deep contour:]* setting is colored white by default.

Deep water color

The color used for the Deep contour can be set to either *white* or *blue*. When set to *blue* the color fill shading is switched so that the Deep water contour will use the darkest shade of blue and the blue fill will get lighter the shallower the contour.

The depth contour settings can be accessed -from the *[Depths]* settings menu: *[Menu > Settings > Depths]*.

RealBathy™ depth contours

Raymarine's RealBathy™ feature allows you to record bathymetry data and create your own depth contours.

When using the RealBathy™ feature, new contour lines are drawn in realtime on the screen based on your transducer's depth readings. Color shading is used to reflect contour depths. The bathymetry data is recorded to the inserted memory card.

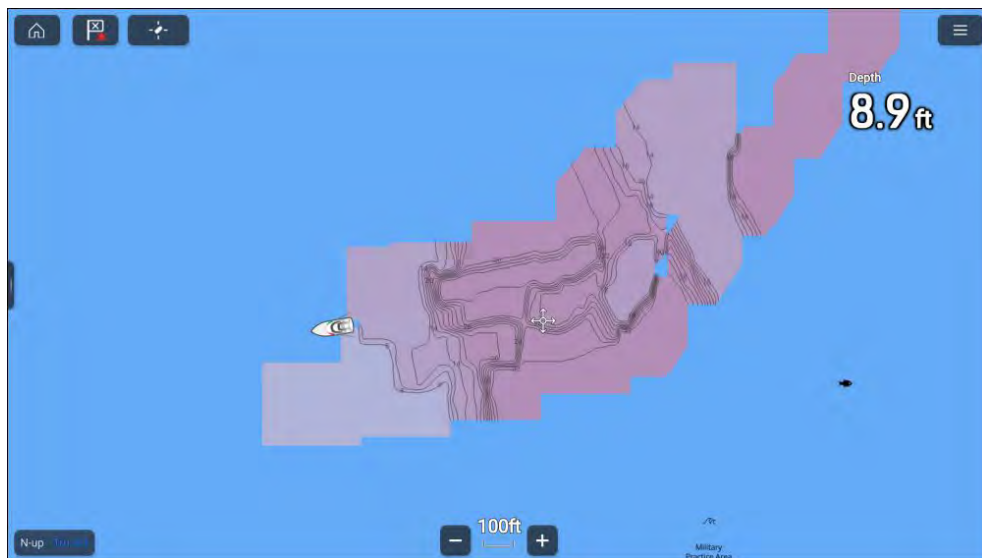

RealBathy™ requirements

RealBathy™ requires the following:

- LightHouse™ vector based charts.
- MicroSD card with sufficient free space to record the bathymetry data.

[Chart app - General](#)

- Distance between waterline and your transducer (item 3 in the below illustration).

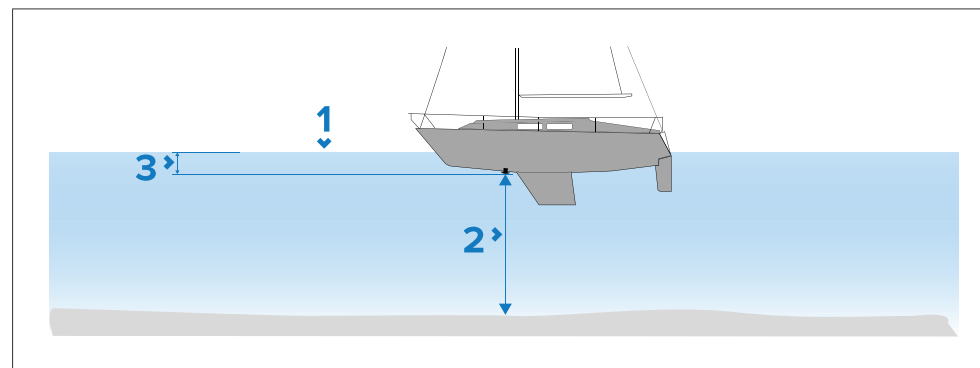

1. Waterline.
2. Water depth below transducer face.
3. Distance above the bottom face of your depth transducer to the waterline.

Creating RealBathy™ depth contours

RealBathy™ depth contours can be created in realtime as you travel.

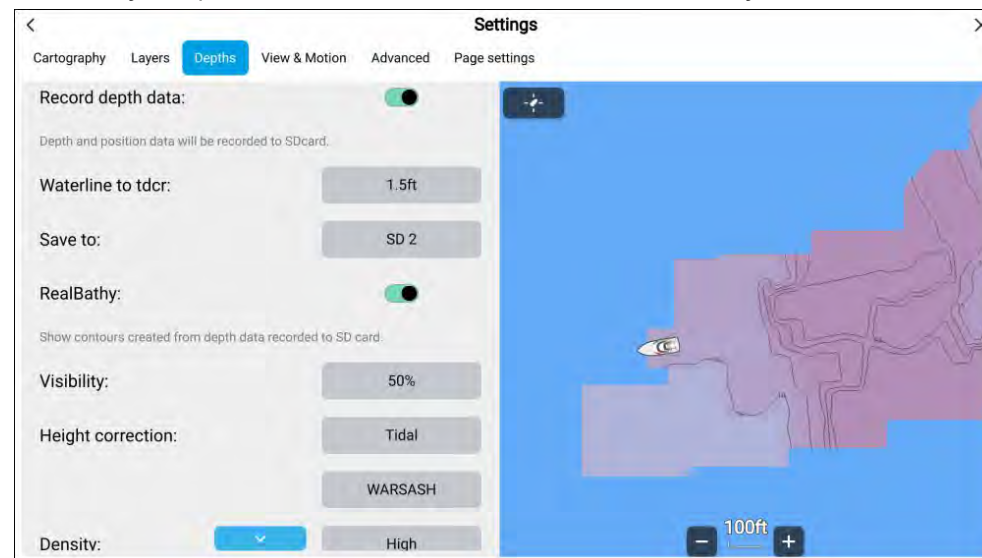

From the Chart app:

1. Select LightHouse charts from the *[Cartography]* menu: *[Menu > Settings > Cartography]*.

2. Open the *[Depths]* settings menu: *[Menu > Depths]*.
3. Select the *[Waterline to tdc]* field and enter the distance between the waterline and the bottom face of your transducer.
4. Select the *[Save to]* field and choose the card reader slot that you inserted your memory card into.
5. Enable the *[Record depth data]* toggle switch.
6. Select *[OK]* on the notification.

Depth and position data will be logged to the selected memory card slot whenever a card with sufficient space is inserted. Chart data will not be overwritten.

Note:

Recording depths is restricted by law in some countries (Sweden, Finland, Norway, China). Please check online to see if restrictions apply for your location.

7. Enable the *[RealBathy]* toggle switch.
The bathymetry data will be displayed onscreen in realtime.
8. Select the *[Height correction]* field and choose an option.
 - *[None]*— No corrections are made.
 - *[Tidal]*— In tidal environments (for example, seas and oceans) select *[Tidal]* and then a list of available stations is displayed, select the closest tide station to your location.
 - *[Lake level]*— In fresh water environments (for example, lakes), select *[Lake level]* and then enter the current reading from the water level marker for your location into the field located under the height correction field.
9. Adjust the *[Visibility:]* setting to the desired transparency.

100% provides full visibility of the RealBathy contours; as the percentage decreases the chart detail behind the RealBathy contours becomes more visible.

10. Select the required *[Density:]* setting.

Steep drop-offs can result in overlapping contour lines; lowering the density in these situations provides a clearer contour.

SonarChart™ Live

You can create personal bathymetry charts using your depth transducer and the SonarChart™ Live feature, available with compatible Navionics® electronic cartography cards.

Note: Before using SonarChart™ Live ensure you have correctly configured your transducer depth settings.

When using SonarChart™ Live, new contour lines are drawn in real time on the screen based on your transducer's depth readings. Color shading is used to reflect depth, with dark red signifying the shallowest area. The sonar data is recorded to your cartography card and is shared with Navionics when you update your chart card online.

Tide correction

SonarChart™ Live records the actual readings from your depth transducer under current tide / water level conditions. You can enable automatic adjustment of depth readings based on normalized low tide / low water level depth data taken from a nearby Tide station.

SonarChart™ Live

Navionics SonarChart™ Live feature allows you to record bathymetry data and create your own depth contours.. SonarChart™ Live requires compatible Navionics® electronic cartography. SonarChart Live is available without an active subscription.

When using the SonarChart™ live feature, new contour lines are drawn in realtime on the screen based on your transducer's depth readings. Color shading is used to reflect contour depths. The bathymetry data is recorded to your Navionics chart card. Bathymetry data can be uploaded to the Navionics website so that the contours can be shared.

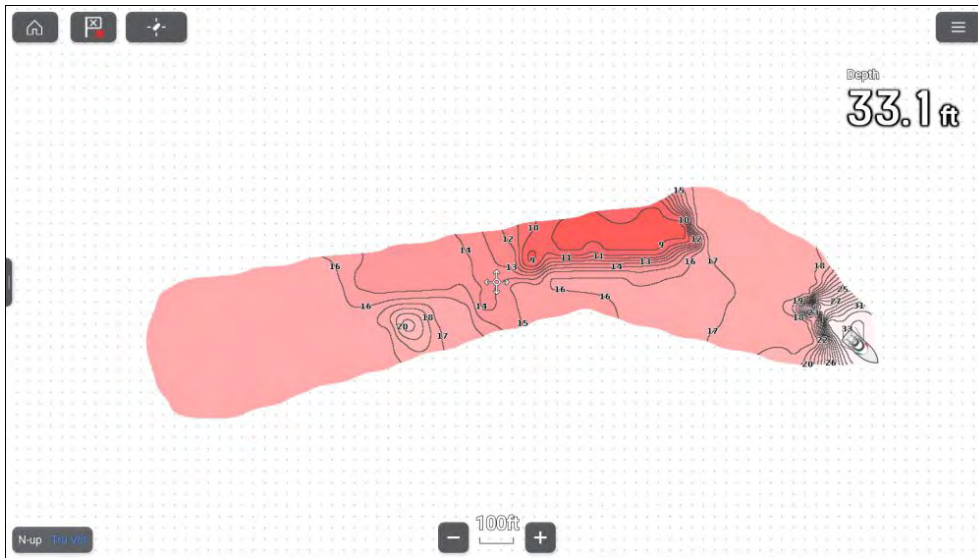

Note:

Ensure you have correctly configured your transducer depth settings.

13.9 Target tracking

The MFD is able to track and display various types of targets to improve situational awareness and collision avoidance. The types of targets which can be tracked are dependent on connected hardware and MFD configuration.

The following types of targets can be tracked:

- **AIS targets** — When a compatible AIS receiver or AIS transceiver is connected AIS targets can be tracked. For details on AIS targets refer to: [AIS targets](#)
- **Radar targets** — When a compatible Radar scanner is connected Radar targets can be tracked. For details on Radar targets refer to: [Radar settings](#)

Targets that are being tracked are displayed onscreen in the Chart app and Radar app using representative icons and are listed in relevant target lists.

The target lists can be accessed by selecting *[Targets]* from the Radar app and Chart app menu: *[Menu > Targets]*, and then selecting the relevant tab.

First responder specific target tracking

[Chart app - General](#)

The following targets can only be tracked when the MFD has been configured using the First responder boating activity during the initial MFD start up wizard:

- **DSC targets** — Vessels sending out a DSC distress call can be tracked. For details on DSC targets, refer to: [p.371 — DSC targets](#)
- **Intel targets** — Targets can be created manually by entering the target’s position, course and speed. Intel targets can be tracked. For details on Intel targets, refer to: [p.369 — Intel targets](#)
- **TOIs** — Targets can be designated as “Targets Of Interest” (TOI). For details on TOIs, refer to: [p.372 — Target Of Interest \(TOI\)](#)

Related topics:

- [p.253 — Navigate mode main menu](#)
- [p.255 — Fishing chart mode main menu](#)
- [p.286 — Racing mode main menu](#)







AIS target tracking

AIS targets

When your MFD is connected to an AIS receiver or AIS transceiver AIS equipped vessels can be displayed as AIS targets in the Chart app and Radar apps. Different icons are used to represent different types of AIS target.







By default the following icons are used:

AIS icons

	Vessel		SART (Search and Rescue Transponder) / MOB (Man Over Board) / EPIRB (Emergency Position Indicating Radio Beacon)
	Land-based station		ATON
	SAR (Search and Rescue)		Virtual ATON

You can enable enhanced AIS target icons from the *[AIS Settings]* menu: *[Menu > Targets > AIS Settings > Enhanced AIS targets]* or the *[Advanced]* settings menu: *[Menu > Settings > Advanced > Enhanced AIS targets]*. When Enhanced AIS targets is enabled the Enhanced AIS icons are used.

Enhanced AIS icons





	Sailing Vessel		Commercial
	High speed vessel / Wing In Ground vessel		Cargo vessel
	Passenger vessel		Other

Enhanced AIS icons are scaled or outlined according to the reported size of the vessel, as shown below:

	Relative length (Gray outline)		
---	--------------------------------	--	--

The status of an AIS target is shown using different colors, outlines and flashing as shown below:

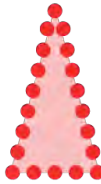
AIS target status

	Lost (No border, crossed through)		Uncertain (Dashed outline)
	Buddy (Yellow fill)		Dangerous and Uncertain (Dashed outline and Flashes Red)
	Dangerous (Flashes Red)		ATON off position (Red border)

Lost SART / MOB / EPIRB targets

When an AIS SART (Search and Rescue Transponder) / MOB (Man Over Board) / EPIRB (Emergency Position Indicating Radio Beacon) target becomes lost it remains onscreen and triggers an alarm notification.

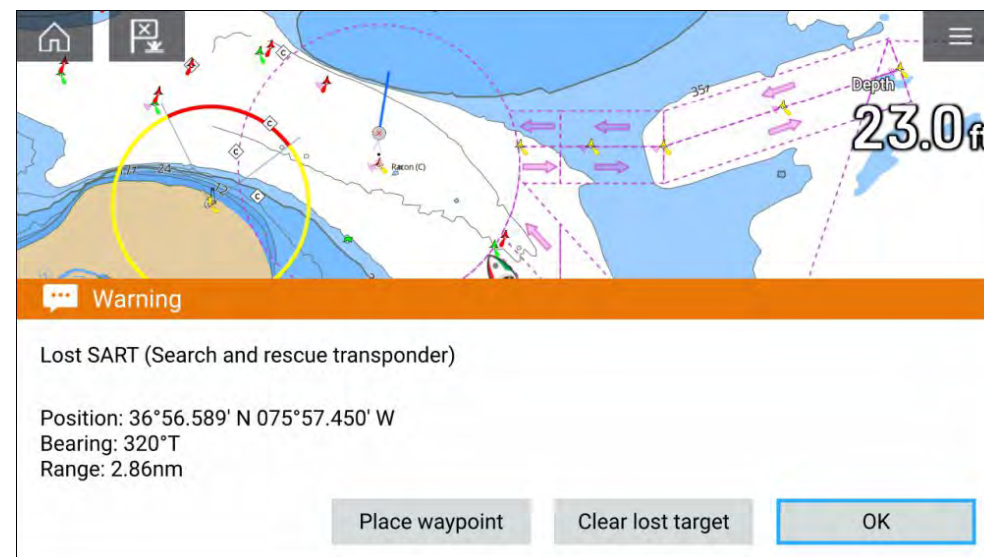

From the Lost target notification you can:

- select *[Place Waypoint]* to place a new waypoint at the last known position of the target.
- select *[Clear lost target]* to remove the target from the system.
- select *[OK]* to dismiss the alarm and keep the target onscreen. The target can be cancelled or a waypoint can be placed from the context menu.

Note:

When the MFD is configured as 'First responder' and is connected to STEDs compatible AIS hardware, Blue Force AIS icons are used to identify other STEDs equipped vessels. For details refer to: [p.376 – Blue Force Tracking](#)

AIS target capacity

The MFD can display a maximum of 200 AIS target simultaneously.

If more than 200 targets exist, within your range, the 200 targets nearest to your vessel will be displayed.

AIS target information

Vessels with AIS transceivers can broadcast programmed vessel information, which can be displayed in the Chart app.

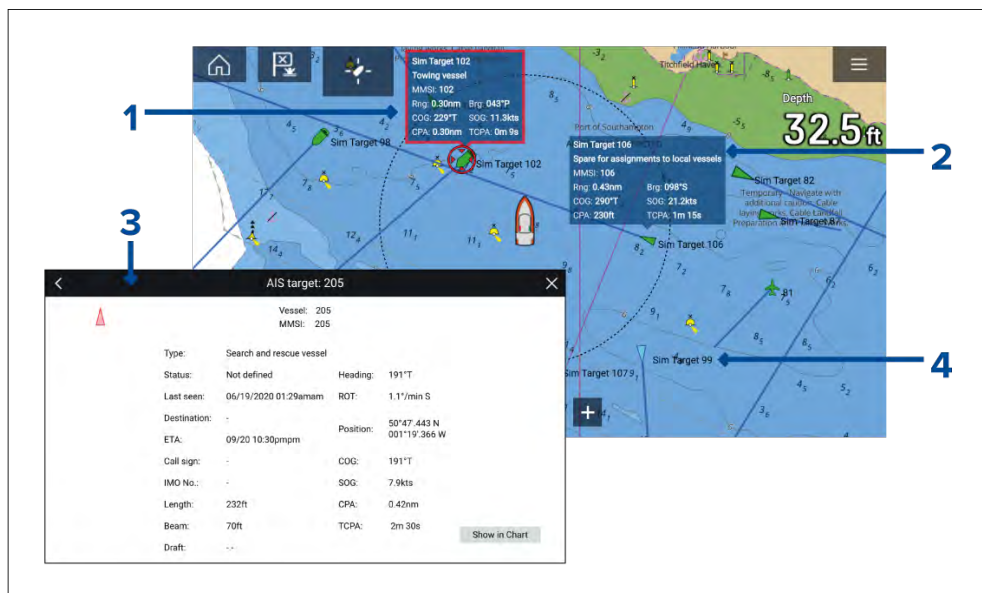

1. Selecting an AIS target icon in the Chart app will display an Infobox containing AIS identification and position information. The Infobox will close automatically after approximately 5 seconds.
2. The Infobox can be switched on and off for individual targets from the AIS target context menu. When switched on, the Infobox is always displayed for the selected target.
3. Full AIS data can be viewed by selecting *[View AIS data]* from the AIS target context menu, or by selecting a target from the target list and selecting *[View full target data]* from the pop-over menu.
4. The AIS target name can be displayed next to the target icon. AIS names can be switched on and off from the *[AIS Settings]* menu: *[Menu > Targets > AIS Settings > AIS names]*.

Full AIS data

The data transmitted by an AIS-equipped vessel can be viewed using the AIS target context menu in the Radar app and Chart app.

Selecting *[View AIS data]* opens the data page:

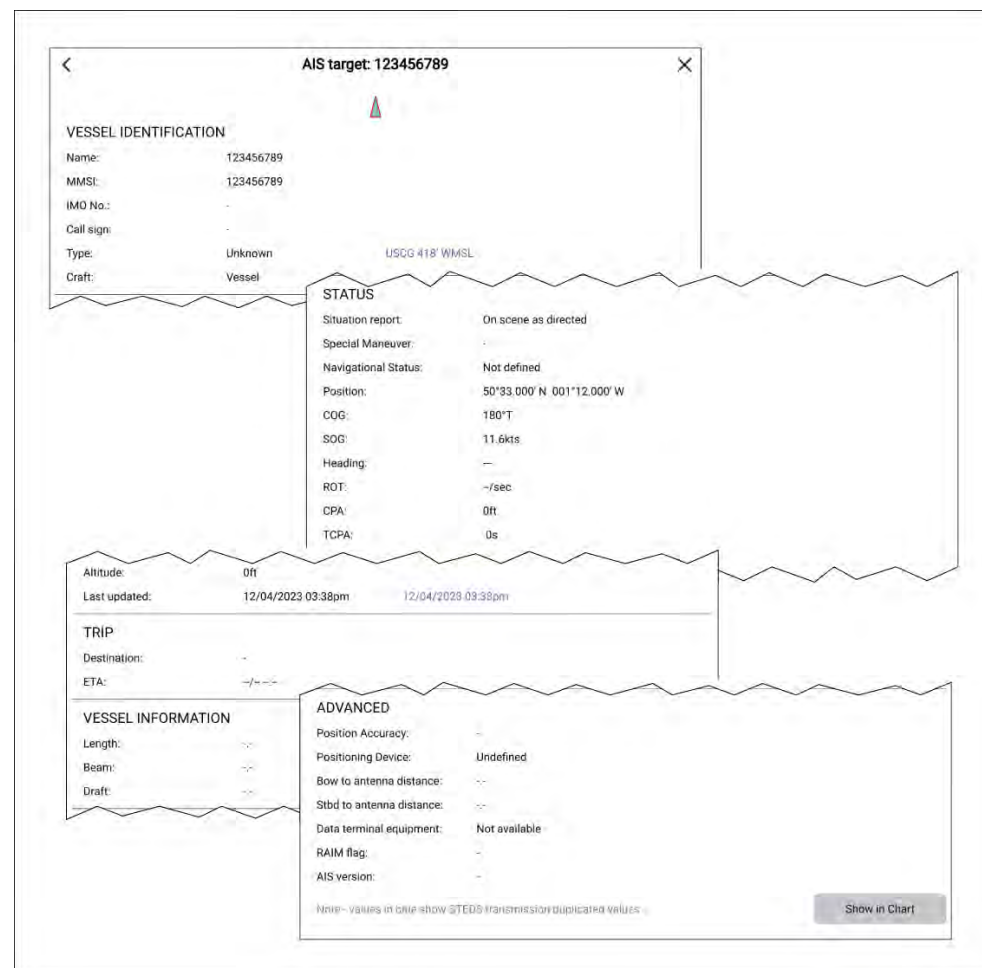

When the MFD is configured using the *First Responder* activity and the system includes a STEDs-compliant AIS transceiver, duplicated STEDs transmission data will be shown in blue, to the right of the AIS data item.

Accessing target options

Target specific options are available for targets that are currently being tracked. The target options can be accessed from the target's context menu and from the Pop-over options in the relevant target list. The options available are dependent on the type of target.

To access a target's context menu:

- Press and hold on the target onscreen, or

- Highlight the target onscreen using the *[Direction controls]* and press the *[OK]* button.

To access the target list Pop-over menu:

- Select the target in the relevant target list, or
- Highlight the target in the list using the *[Direction controls]* and press the *[OK]* button.

AIS target options

The following options are available for AIS targets.

- *[View full target data]*— View fullscreen page displaying all available AIS data.
- *[Add as buddy]*— Add the target as a buddy. The Buddy feature enables you to add AIS-equipped friends and regular contacts as ‘buddies’. Buddy vessels will be displayed onscreen and in the target list using the Yellow AIS buddy icon. When assigning an AIS target as a buddy you can customize the name that is used for the target vessel. The following additional Target list Pop-over options are available for buddy vessels:
 - *[Remove as buddy]*— The target will revert to using normal AIS target icon.
 - *[Edit buddy name]*— Change the Name of the buddy target.
- *[Intercept]*— Initiates a Target interception. For details see: [p.238 — Target intercept](#)

AIS target list

The target list identifies: Target name, Range and Bearing from your vessel. Where relevant, CPA (Closest point of approach) and TCPA (Time to Closest Point of Approach) values will also be displayed.

The AIS targets list can be accessed from the Targets menu in the Radar app and Chart app: *[Menu > Targets > AIS]*

The target list is sorted by target proximity to your vessel with the closest target appearing at the top of the list. The list will automatically update as targets become closer or farther away.

Selecting a target from the list highlights the selected target in the LiveView app pane on the right of the page and opens the Pop-over menu.

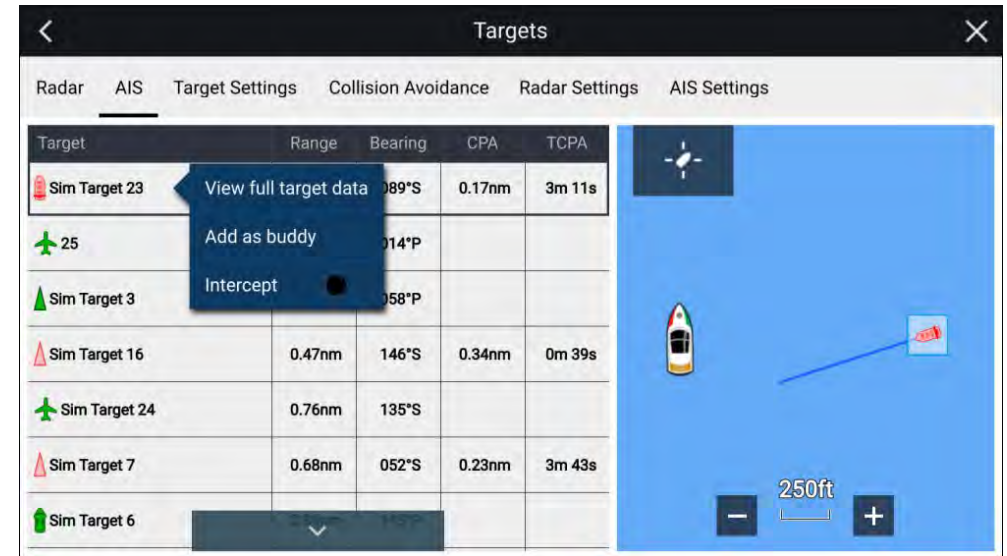

AIS settings menu

You can configure AIS target settings from the *[AIS Settings]* menu: *[Menu > Targets > AIS Settings]*.

The following options are available:

- *[Show AIS targets in chart]* / *[Show AIS targets in Radar]*— Enables and disables display of AIS targets in the Chart app / Radar app.
- *[Enhanced AIS targets]*— Enables and disables the display of enhanced AIS target icons.
- *[AIS names]*— When enabled, AIS target names are permanently displayed next to AIS target icons.
- *[Show these AIS types]*— Enables selection of the types of AIS target that will be displayed. Available AIS types:
 - All
 - Dangerous
 - Buddies
- *[Hide static targets]*— When enabled, AIS targets travelling under 2 knots will not be displayed, unless it is or becomes dangerous.
- *[Silent mode (don't transmit my position)]*— When enabled, your vessel's AIS transceiver will not transmit your position or details to other AIS equipped vessels.

Radar target tracking

Radar targets

Radar target symbols are used to identify Radar targets onscreen.

Radar targets are displayed in the Radar app and when Radar overlay is enabled (*[Chart app > Menu > Targets > Radar settings > RADAR OVERLAY > Show radar overlay]*) they are also displayed in the Chart app.

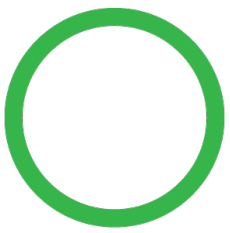
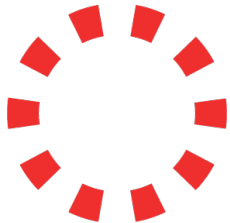
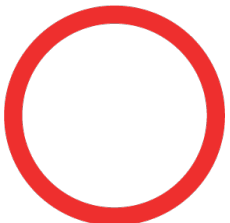
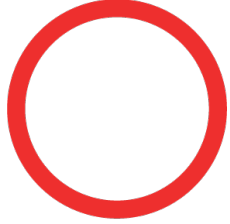
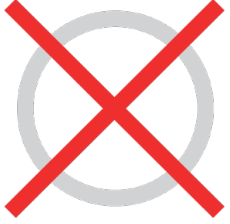
	Acquiring target (manual) — Thin dashed Green circle		Acquired target (manual) — Green circle with Target ID
	Acquiring target (auto) — Thick dashed Red circle, flashes until acknowledged		Unacknowledged acquired target (auto) — Red circle, flashes until acknowledged
	Dangerous target — Red circle with Target ID, flashes until acknowledged		Lost target (Target not detected for 4 Radar scans) — Gray circle with Red cross through

Once acquired the target's COG (Course Over Ground) and SOG (Speed Over Ground) can be displayed below the target ID.

The Target info is colored Blue if COG and SOG values are True or Orange if values are Relative. Target info will turn Red if the target becomes dangerous.

Acquiring a target manually

To acquire a Radar target manually using MARPA (Mini Automatic Radar Plotting Aid) follow the steps below.

With the Radar overlay enabled:

1. Select the object / target.
The context menu is displayed.
2. Select *[more options]*.
3. Select *[Acquire target]*.
Once acquired the target will be tracked.

Accessing target options

Target specific options are available for targets that are currently being tracked. The target options can be accessed from the target's context menu and from the Pop-over options in the relevant target list. The options available are dependent on the type of target.

To access a target's context menu:

- Press and hold on the target onscreen, or
- Highlight the target onscreen using the *[Direction controls]* and press the *[OK]* button.

To access the target list Pop-over menu:

- Select the target in the relevant target list, or
- Highlight the target in the list using the *[Direction controls]* and press the *[OK]* button.

Radar target options

The following options are available for Radar targets.

- *[Cancel target]* — Cancels the Radar target. Once cancelled the target symbol will no longer be displayed onscreen or be listed in the target list.

Note: Cancelled targets will not be tracked and will not trigger the dangerous target alarm.

- *[Show CPA]* — Determines when CPA graphics are displayed onscreen
The following options are available:

- *Auto* — CPA graphic is displayed if the target becomes dangerous (based on the Dangerous target alarm settings).
- *On* — CPA graphic is displayed if there is an interception point between your vessel's current course and the target's.
- *Off* — CPA graphic is not displayed for the target.

Note: CPA graphics are only displayed in the Radar app. The *[Show CPA]* option is not available in the Chart app.

- *[Target info]* — Enables and disables display of the target's Course (COG) and speed (SOG) onscreen.
- *[Intercept]* — Set target interception. For details see: [p.238 — Target intercept](#)

Radar target list

The target list identifies: Target number, Range and Bearing from your vessel. Where relevant, CPA (Closest point of approach) and TCPA (Time to Closest Point of Approach) values will also be displayed.

The Radar target list can be accessed from the Targets menu in the Radar app and Chart app: *[Menu > Targets > Radar]*.

The Radar target list can be sorted by either *Number* or *Range* by selecting the *[Sorted By]* option located at the bottom of the LiveView pane:

- *Number* — List sorted by Target number so that the first detected target appears at the top of the list.
- *Range* — List sorted by proximity to your vessel with the closest target appearing at the top of the list. The list will automatically update as targets become closer or farther away.

Selecting a target from the list highlights the selected target in the LiveView app pane on the right of the page and opens the Pop-over menu.

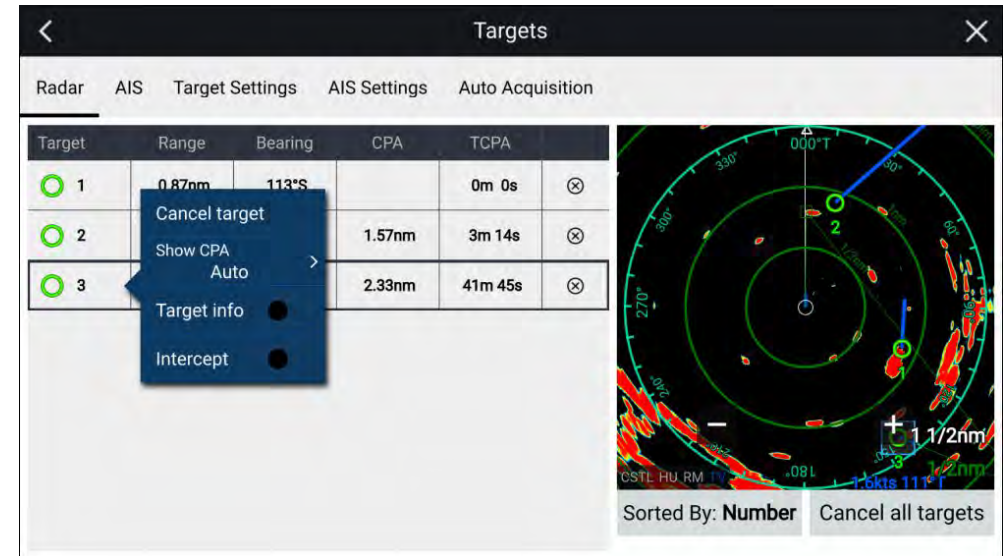

Radar targets can be cancelled individually by selecting the '*[X]*' next to the target's details in the list, or you can cancel all targets by selecting *[Cancel all targets]*.

Radar settings

When the Radar layer is enabled in the Chart app you can configure the *[Radar settings]* from the *[Targets]* menu: *[Menu > Targets > Radar settings]*.

The following options are available:

- *[Radar selection]* — When more than 1 Radar scanner is connected you can choose which Radar to use for the Radar layer in the Chart app.
- *[Transmit]* — Start the Radar scanner transmitting or put it in Standby.
- *[Dual range]* — Enables and disables dual range on compatible Radar scanners.
- *[Channel]* — When Dual range is active, you can switch between channel 1 and 2.
- *[Sync radar range with chart]* — Enables and disables the synchronization of Chart app range with all Radar app instances on the same app page.

Note: The current range is synchronized when the setting is enabled. Subsequent range changes in either the selected Chart app instance or any Radar app instance on the same app page will be synchronized.

- *[Show Radar overlay]*— Enables and disables the Radar layer in the Chart app.
- *[Visibility]*— Determines the percentage visibility (opacity) of the Radar layer.
- *[Palette]*— The Radar overlay can be displayed in the following colors:
 - Full Color (256 colors)
 - Purple
 - Black
 - Red

Note: When 'Full color' is selected, approaching objects are displayed in Pink.

- *[Show sector blanking limits]*— Enables and disables blank sectors on compatible radar scanners. For more information on blank sectors refer to [22.15 Blank sectors](#)
- *[DOPPLER]*— Enables and disables Doppler on compatible radar scanners. For more information on Doppler refer to [22.14 Doppler Radar overview](#)

Note: If 'Full color' is selected for the Radar overlay palette, approaching targets will appear Pink instead of Red.

- *[Use COG when no Heading data available]*— Enables use of the Radar layer when Heading data is not available.
- *[Range]*— Determines the range used for the Radar layer.

Target vector settings

Target vectors show the predicted future path of the target.

Target vector settings can be accessed from the *[Targets]* setting menu: *[Menu > Targets > Target settings]*.

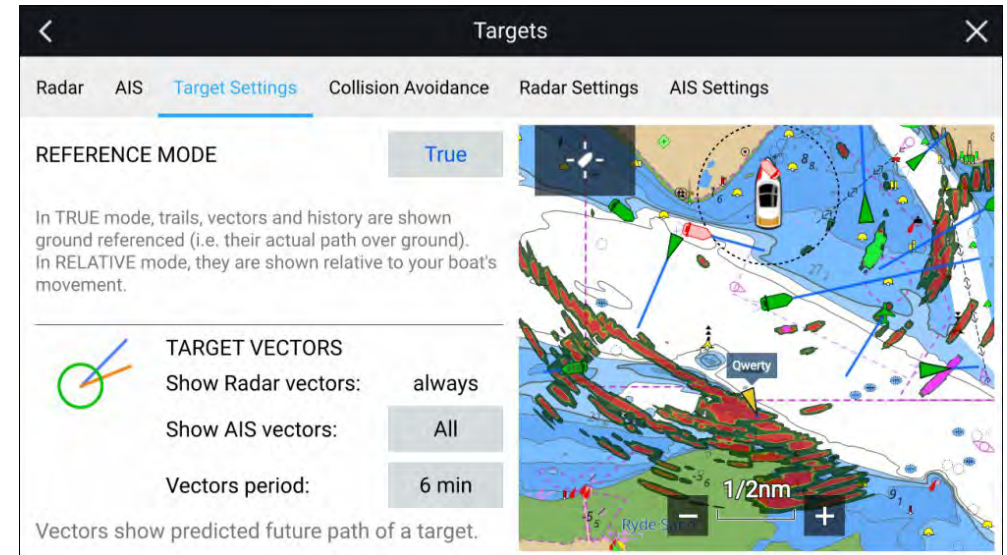

The reference mode for vectors can be set to *[True]* or *[Relative]*.

- In *[True]* reference mode, trails, vectors and history are shown ground referenced (i.e. their actual path over ground).
- In *[Relative]* reference mode, trails, vectors and history are shown relative to your vessel's movement.

Vectors are always displayed for Radar targets. Vectors for AIS targets can be set using the *[Show AIS vectors]* option. The available options are:

- *[All]*— vectors are displayed for all AIS targets.
- *[Manual]*— vectors only displayed when enabled individually for each target using the target context menu.

The length of the vector identifies where the target will be after the time specified in *[Vector period]* has passed.

13.10 Collision avoidance

In addition to target tracking specific collision avoidance features are available to improve awareness for the potential of collisions.

The specific collision avoidance features are:

- Dangerous targets alarm. Refer to: [p.231 — Dangerous targets alarm](#)
- Radar guard zones. Refer to: [p.350 — Guard zone alarms](#)

- Predicted areas of danger. Refer to: [p.231 – Predicted areas of danger](#)
- LightHouse chart obstruction alarm. Refer to: [p.236 – Obstruction alarm \(legacy LightHouse charts\)](#)

Dangerous targets alarm

Use the Dangerous targets alarm to notify you if a Radar target or AIS target will reach a specified distance from your vessel within a specified time.

The Dangerous targets alarm settings can be accessed from the *[Collision Avoidance]* menu: *[Menu > Targets > Collision Avoidance]*.

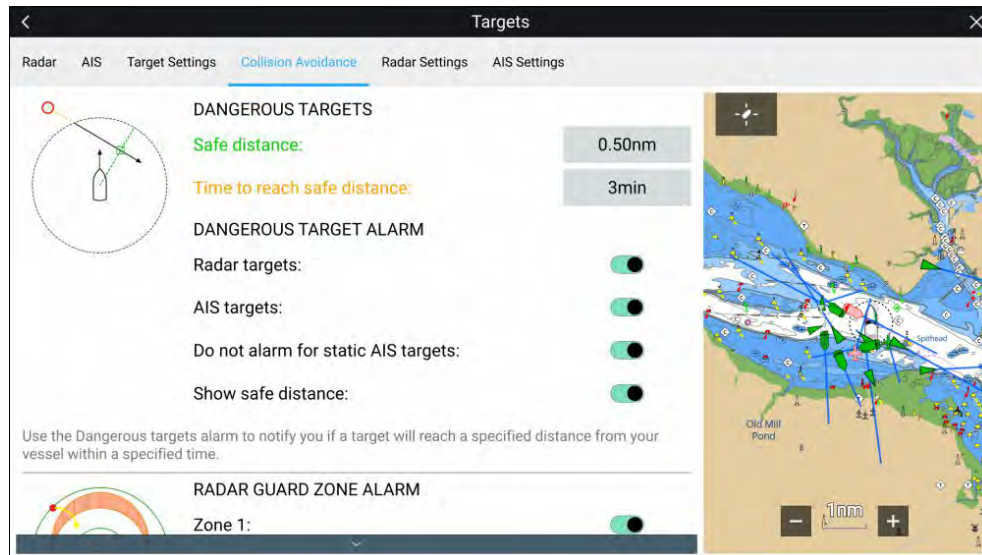

To set up the Dangerous targets alarm, adjust the *[Safe distance]* to the desired value and then select a *[Time to reach safe distance]*. The alarm will be triggered if a tracked target will reach the specified Safe distance from your vessel within the time period selected.

The following additional options are available for the dangerous targets alarm:

- *[Radar targets]*— Enables Radar targets to be included in the dangerous targets alarm. If this setting is disabled Radar targets will not trigger the dangerous targets alarm.
- *[AIS targets]*— Enables AIS targets to be included in the dangerous targets alarm. If this setting is disabled AIS targets will not trigger the dangerous targets alarm.

- *[Do not alarm for static AIS targets]*— Enables ability to ignore AIS targets that are considered static (travelling under 2 Knots). Static targets that become dangerous will still be identified onscreen but will not trigger the dangerous targets alarm.
- *[Show safe distance]*— Enables display of a safe distance circle around your vessel.

Predicted areas of danger

The Predicted areas of danger feature tracks Radar targets and AIS targets in relation to your own vessel's Course Over Ground (COG) and Speed Over Ground (SOG).

If your paths are predicted to cross, an Interception line is displayed between your vessel and the target. Additionally, Interception zones are displayed to indicate where there is an increased risk of collision. The Interception line and the Interception zones are based on your current course and speed and the target's current course and speed, and they can help you determine whether you should change course and / or speed to avoid a potential collision.

The graphics automatically refresh when the MFD receives new position data from the target.

Important:

The Collision Avoidance feature is a graphical aid only, provided to help increase user awareness of the potential for collision. It is vital to have a good understanding of the *International Regulations for Preventing Collisions at Sea (IRPCS / COLREGS)*, to ensure all actions taken are in accordance with the IRPCS. Important concepts to understand in relation to Collision Avoidance include (but are not limited to): Risk assessment; Right of Way; Restricted visibility; interpreting lights and shapes; interpreting sound and light signals. In the event of conflict, the IRPCS regulations must take precedence. For more information on IRPCS / COLREGS, refer to: [IRPCS](#)



Moving target graphics

Moving target graphics are used for targets moving at a speed greater than 2 kts.

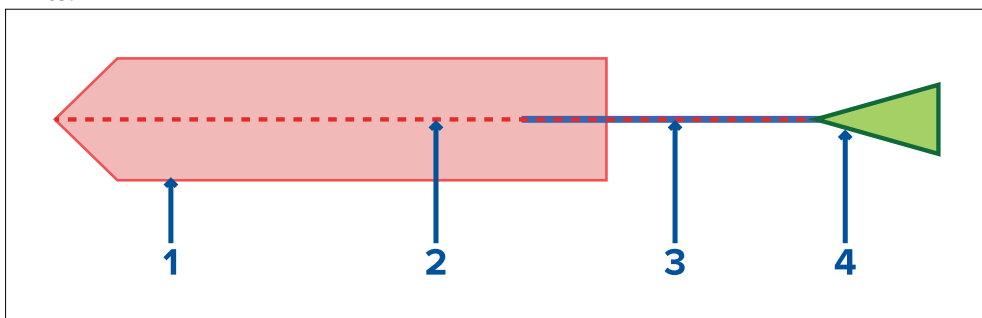

1. Interception zone (Predicted area based on target's last reported position)
2. Interception line
3. Target COG line
4. AIS Target (Last received position)

Stationary Target graphics

Stationary target graphics are used for targets moving at a speed less than 2 kts.

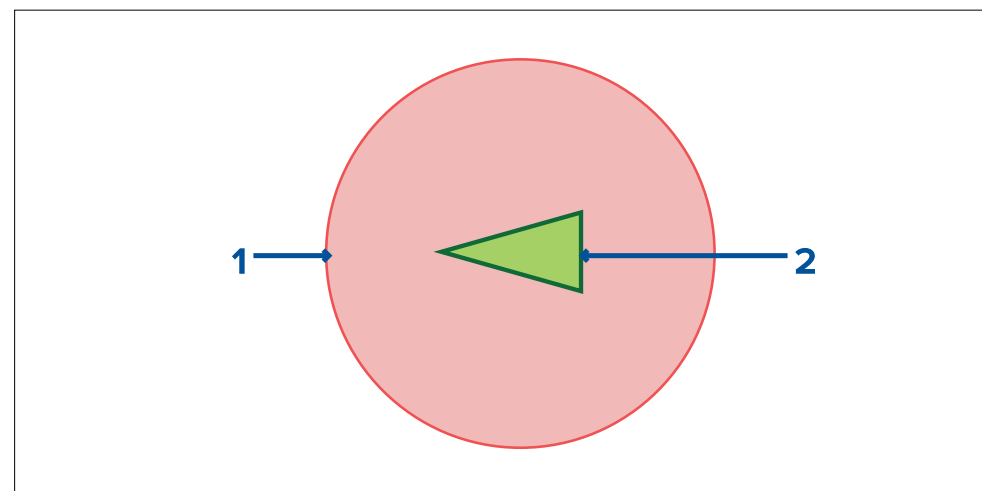

1. Interception zone (Predicted area based on target's last reported position)
2. Stationary AIS Target (Last received position)

Important:

You must still maintain a permanent watch for:

- Vessels that are not equipped with AIS or AIS-equipped vessels that are not currently transmitting their position, as these targets will not be displayed in the Chart application.
- AIS-equipped vessels reporting an inaccurate GPS position, your own vessel's GPS accuracy, or AIS targets with delayed location updates. These situations will cause your vessel's position and / or AIS target positions to be displayed inaccurately in the Chart application.
- Objects not detected by your Radar scanner.

Predicted areas of danger settings

The Predicted areas of danger feature can be enabled for AIS targets and Radar targets in the Chart app.

[Chart app > Menu > Targets > Collision Avoidance]

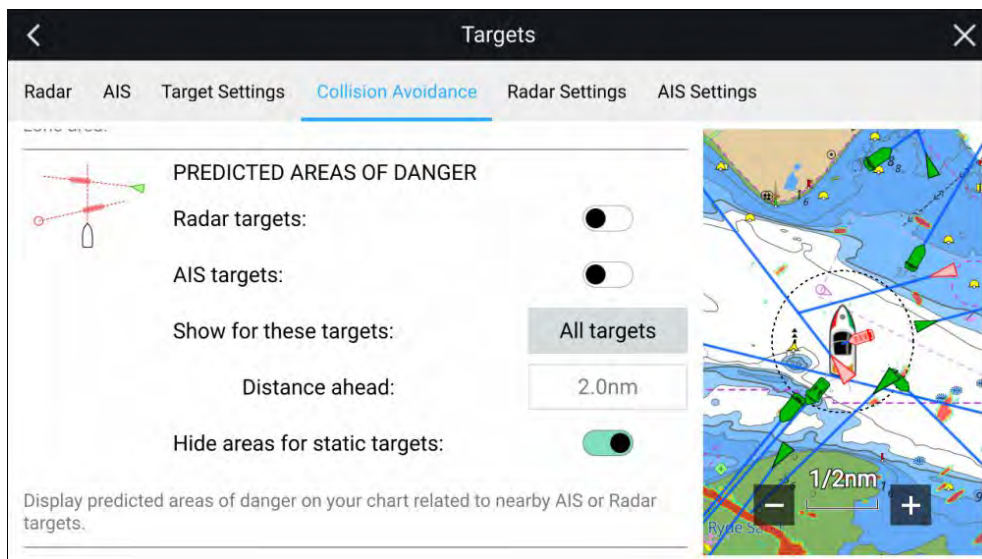

In the *[Collision Avoidance]* menu you can change the settings to determine which types of target (i.e. AIS and Radar) will have an Interception zone:

- *[Radar targets]*— Enables and disables Predicted area of danger graphics for detected Radar targets.
- *[AIS targets]*— Enables and disables Predicted area of danger graphics for AIS targets.
- *[Show for these targets]*— Determines when Predicted area of danger graphics are displayed. Graphics can be displayed for:
 - *[All targets]*— all targets onscreen.
 - *[Targets crossing my course]*— only targets which are predicted to cross your vessel's path
- *[Distance ahead]*— Changes the distance ahead of your vessel that the Interception line is drawn (only available with *[Targets crossing my course]* selected). The distance can be set to a value between 0.5 nm to 5.0 nm.
- *[Hide areas for static targets]*— Enables and disables graphics for Static targets, targets travelling less than 2.0 kts will NOT have Predicted area of danger zones.

Collision scenarios

There are 3 potential scenarios the Predicted areas of danger feature can warn you about:

- Own vessel moving faster than target
- Target moving faster than own vessel
- Both targets moving at similar speed

Example scenario 1 — Own vessel moving faster than target vessel

Note: These scenarios are examples provided for guidance only.

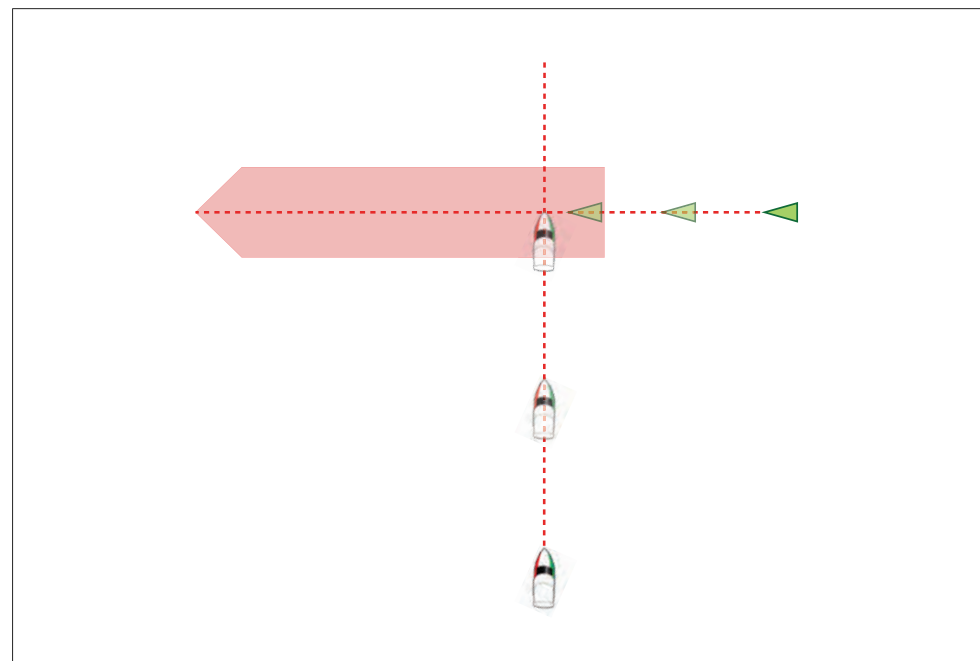

In the example above the vessel's COG will cross with the target's COG within the Interception zone, which could cause a collision. You should alter course and / or speed to avoid the potential collision.

Scenario 1 Course change examples

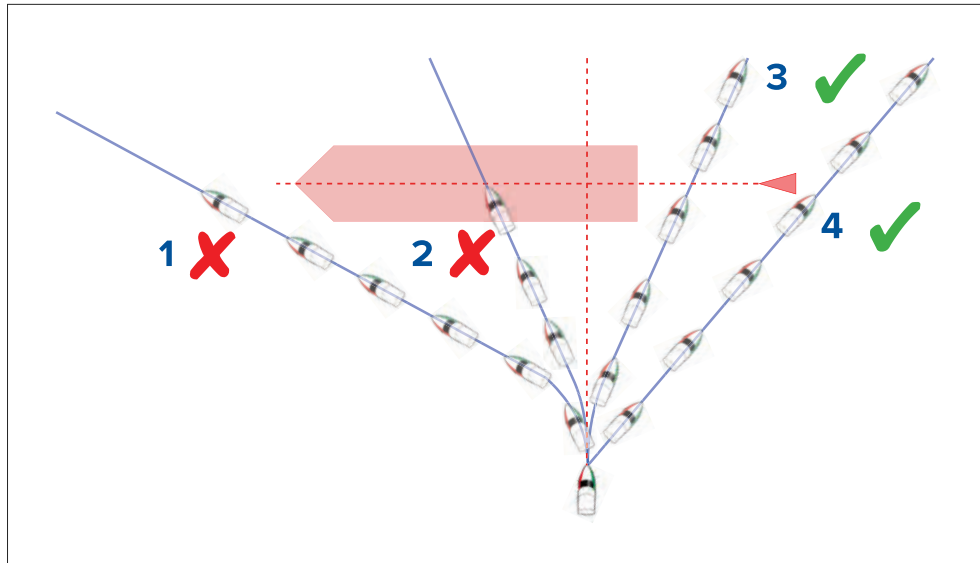

1. Course alteration to pass ahead of the Interception zone [Not recommended] — Proceed with caution, there is always an inherent risk when passing in front of other vessels.
2. Course alteration to pass ahead of the target vessel [Not recommended] — This manoeuvre is not recommended as your vessel will still cross through the target's Interception zone.
3. Course alteration to pass astern of the target vessel and its Interception zone — This manoeuvre alters your vessel's course so that it does not come into contact with the target's Interception zone and passes astern of the target.
4. Course alteration to pass clear astern of the target vessel and its Interception zone. This is the preferred manoeuvre as it correctly alters your vessel's course so that it is clear of the target's Interception zone and passes safely astern of the target. This manoeuvre also clearly indicates to the target vessel your actual change of course.

Figure 2. Scenario 1 Speed change examples

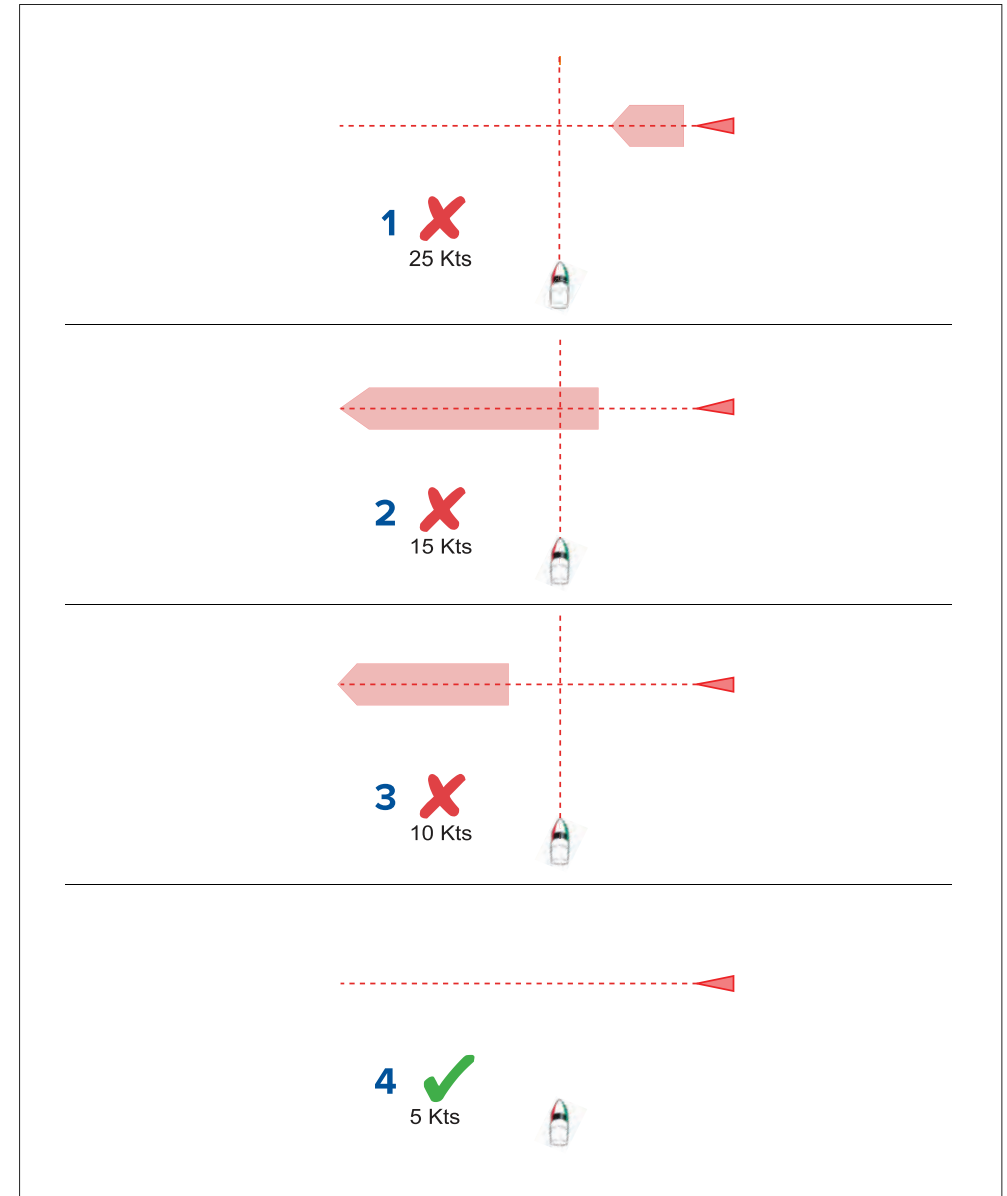

1. ⁽¹⁾Speeding up [Not recommended] — Increasing vessel speed to pass ahead of the target vessel. Proceed with caution, there is always an inherent risk when passing in front of other vessels.

2. No speed change [Not recommended] — Not changing speed or course is not an option as it can result in a collision.
3. Slowing down [Not recommended] — Slowing down a sufficient amount will allow the target vessel to pass ahead of your vessel.
4. ⁽²⁾Slowing down — Slowing down more than a sufficient amount will allow the target vessel to pass safely ahead of your vessel.

Note:

- ⁽¹⁾ In this example the paths will still cross within the [Intercept distance], so the graphics are still displayed.
- ⁽²⁾ In this example the paths will no longer cross within the [Intercept distance], so the graphics are not displayed.

Example scenario 2 — Target vessel moving faster than your vessel

Note: These scenarios are examples provided for guidance only.

In certain situations, when the target vessel is travelling faster than your vessel, there may be more than one opportunity for your paths to cross within the [Intercept distance]. If this is the case then a second Interception zone is displayed.

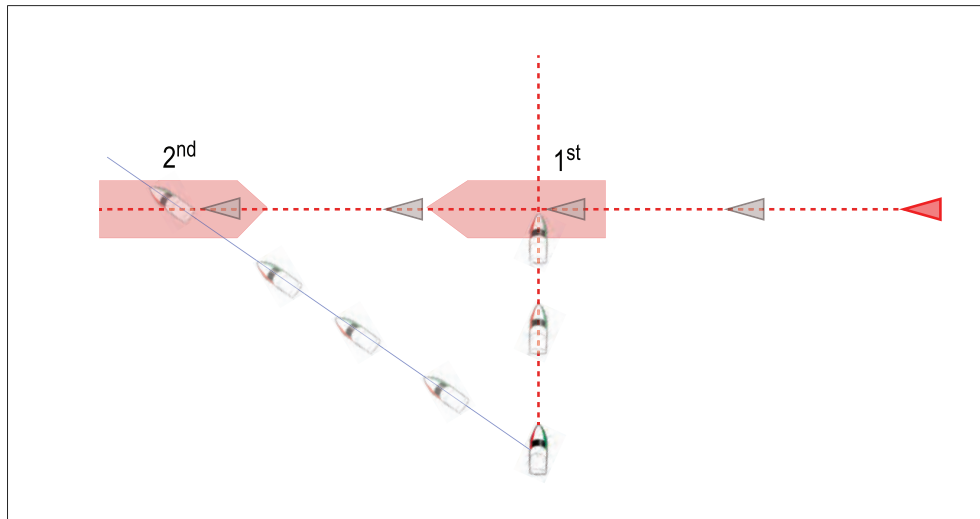

1. 1st — The first Interception zone (displayed closest to the target vessel) represents a bow-to-bow collision.
2. 2nd — The second Interception zone (displayed farthest from the target vessel) represents the target vessel running you down from behind.

When altering course and speed, both Interception zones must be avoided.

Scenario 2 Course change examples

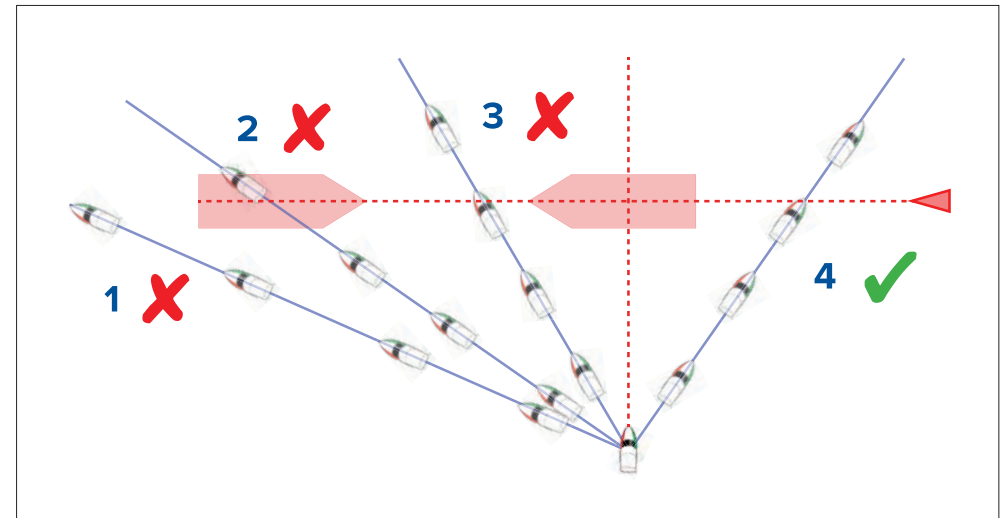

1. Course alteration to pass ahead of the Interception zone [Not recommended] — As the target vessel is moving faster than your vessel you will pass astern of the target.
2. Course alteration to pass ahead of the first Interception zone [Not recommended] — Although this course alteration is sufficient to avoid a potential bow-to-bow collision, it has created a second Interception zone where the target may now run you down from behind.
3. Course alteration to pass between the 2 Interception zones [Not recommended] — Although this may seem like the quickest option, proceed with caution, as the gap between the 2 Interception zones can close quickly, especially when your vessel slows down.
4. Course alteration to clear astern of the target vessel and its Interception zone. This would be the preferred manoeuvre as it correctly alters your vessel's course so that it is clear of the target's Interception zone, and passes safely astern of the target. This manoeuvre also clearly indicates to the target vessel your change of course.

Figure 2. Scenario 2 Speed change examples

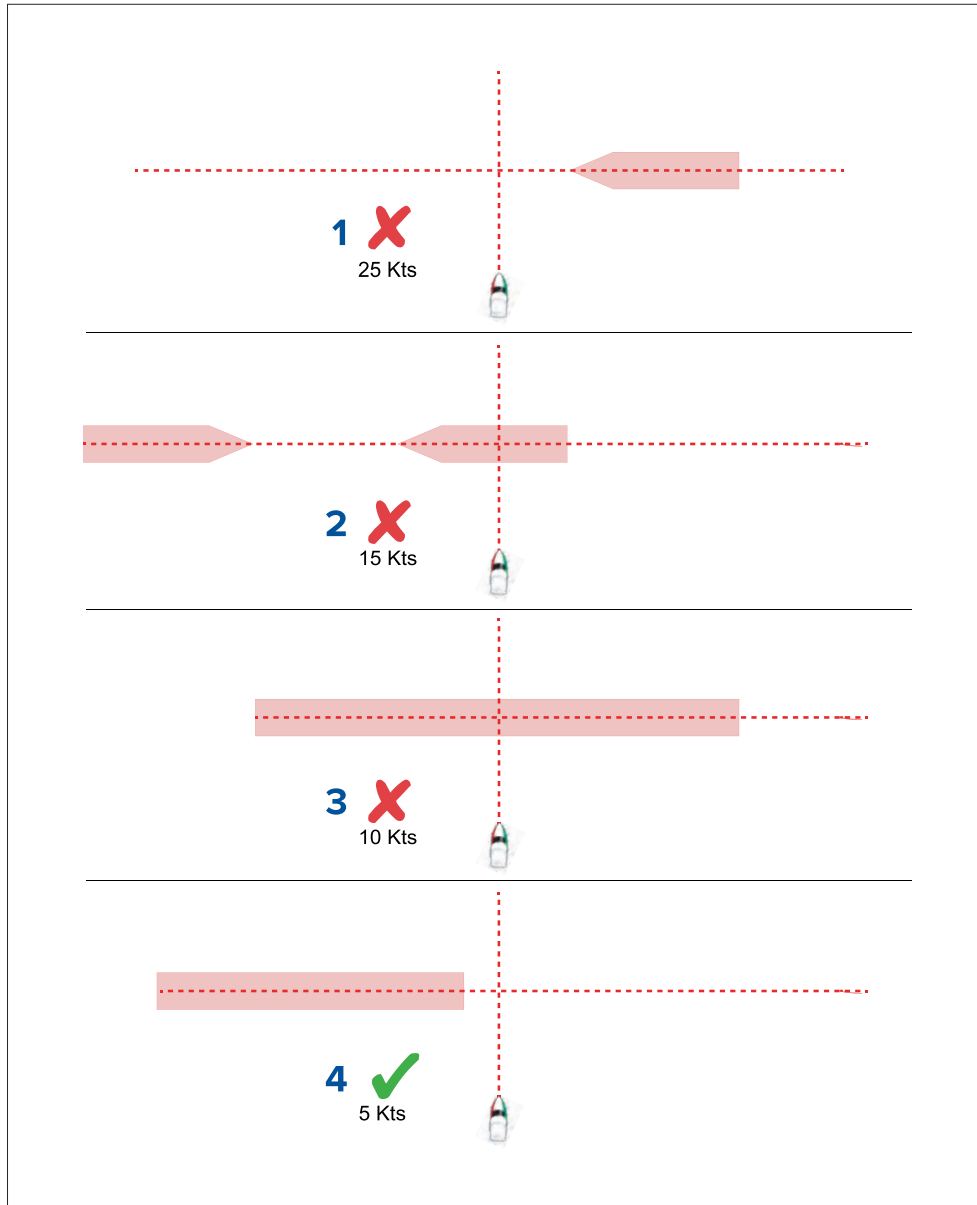

1. Speeding up [Not recommended] — Increasing vessel speed to pass ahead of the target vessel. Proceed with caution, there is always an inherent risk when passing in front of other vessels.
2. No change [Not recommended] — Not changing speed or course may result in a collision.
3. Slowing down [Not recommended] — Slowing down slightly may result in the 2 Interception zones closing up or merging into a single zone.
4. Slowing down — Slowing down a sufficient amount will allow the target vessel to pass safely ahead of your vessel, avoiding the Interception zone(s).

Example scenario 3 — Both vessels travelling at the same speed

Note: These scenarios are examples provided for guidance only.

Course change

When both vessels are travelling at the same speed, course alterations should be made in accordance with the guidance provided in examples 1 and 2.

Speed change

When both vessels are travelling at the same speed, altering your speed will change the collision scenario to one of the scenarios detailed in examples 1 and 2.

Obstruction alarm (legacy LightHouse charts)

The Obstruction alarm provides a warning if a charted object, charted depth contour or charted height clearance is detected that conflicts with the MFD's configured [*Safety depth*] and / or [*Safety height*] settings.

Note:

- The Obstruction alarm requires Legacy LightHouse™ vector charts as the alarm's [*Cartography source*].
- Object depths, depth contours and clearance heights are based on the cartography in use.
- If an obstruction is not present in the specified [*Cartography source*] it will not trigger the alarm.



When the Obstructions alarm is triggered an alarm notification is displayed and an audible beep is sounded on the MFD. From the onscreen notification you can acknowledge the alarm by selecting *[OK]*, or edit the alarm parameters by selecting *[Edit]*.

Obstruction alarm parameters

The Obstruction alarm parameters must be configured from the *[Alarm manager]* before it can be used: *[Homescreen > Alarms > Settings > LightHouse chart obstructions]*.

The following options must be configured for correct operation:

- *[LightHouse chart obstructions]*— Enables and disables the obstruction alarm.
- *[Indication only]*— Enables and disables the warning notification dialog (Audible beep and Red detection zone outline only).
- *[Cartography source:]* — Choose the appropriate (legacy) LightHouse chart for your region.
- *[Safety depth]*— Specifies the minimum safe depth for your vessel. The Chart app's *[Safe contour]* depth value is synchronized with the Safety depth value.
- *[Safety height]*— Specifies the minimum height for your vessel.
- *[Obstruction warning ahead]*— Specifies how much time in advance of reaching the obstruction the alarm will be triggered. This means the faster your vessel speed is, the farther ahead the detection zone will be drawn.
- *[Minimum obstruction distance]*— Refers to the distance from your vessel boundary to the (virtual) obstruction detection zone around the vessel. This parameter specifies the minimum distance from your vessel to the obstruction detection zone, in 4 directions: port, starboard, aft and (when motionless), fore. The obstruction detection zone is displayed in the Chart app as an oblong shape around your vessel, and turns Red when an obstruction is detected.

Obstruction alarm detection zone

If a Chart app instance is opened that uses the same legacy LightHouse™ charts cartography as the Obstruction alarm's *[Cartography source]*, then a detection zone is drawn around the vessel icon. The detection zone outline turns Red when the Obstruction alarm is triggered.



1. When there is no obstruction present, the detection zone outline is colored black until an obstruction is detected.
2. When the charted depth is the same depth as, or less than the specified safety depth, the Obstruction alarm is triggered.
3. When the charted object is the same depth as, or less than the specified safety depth, the Obstruction alarm is triggered.

Once the Obstruction alarm has been configured, the alarm parameters can be modified from the *[Collision avoidance]* menu tab in the Chart app: *[Chart app > Menu > Targets > Collision Avoidance > LightHouse obstruction alarm]*.

Note:

- You will not be able to use the Obstruction alarm if the *[Cartography source]* has not been set in the Alarms manager.
- Obstructions may not be displayed at all Chart app ranges, so you may need to Range in to see the object that triggered the Obstruction alarm.

LightHouse charts dangerous objects

When using LightHouse™ charts or Legacy LightHouse™ vector charts objects deemed as dangerous are highlighted using a purple octagon symbol with an 'x' in the center.

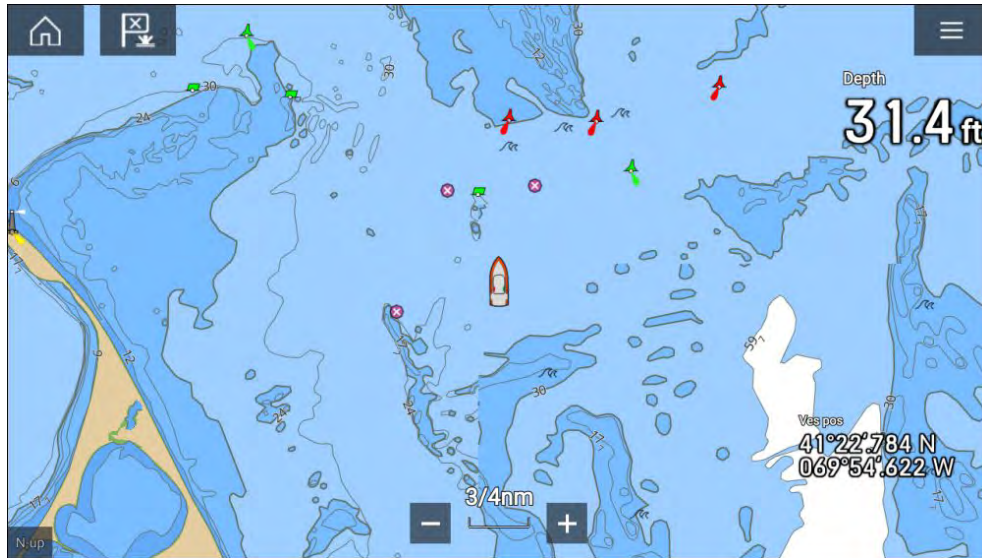

Objects such as wrecks, that are in the Deep contour that are shallower than the depth specified in the Safety contour will be highlighted using the Danger symbol.

Height restrictions such as bridges, are always highlighted using the Danger symbol.

Note:

When using Legacy LightHouse™ vector charts the display of Danger highlight symbols can be enabled and disabled from the Chart app's [Advanced] menu tab: [Menu > Settings > Advanced > Danger highlights].

13.11 Target intercept

The [Intercept] feature can be used to help rendezvous with friends or for Pilot boats and the Coast Guard to intercept vessels that are to be boarded.

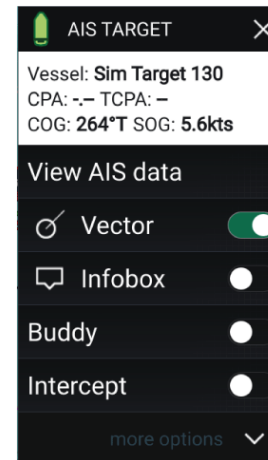

To use the [Intercept] feature, select and hold the target icon until the context menu is displayed, then select [Intercept]. The Chart app will automatically plot a direct course to a point where your vessel and the target will cross (intercept).

An interception mark is placed at a predicted point where both your vessel and the target will cross.

Important:

When performing an individual interception, you are placing your vessel on a collision course with the target vessel. **In order to prevent a collision, it WILL be necessary to change to a parallel course.**

Pre-requisites:

- It is vital to have a good understanding of the *International Regulations for Preventing Collisions at Sea* (IRPCS / COLREGS), to ensure all actions taken are in accordance with the IRPCS. For more information on IRPCS / COLREGS, refer to: [IRPCS](#)
- You must be familiar with the AIS feature.
- You must have a thorough understanding of the Target interception feature and its implications before attempting to use it in a real life scenario.

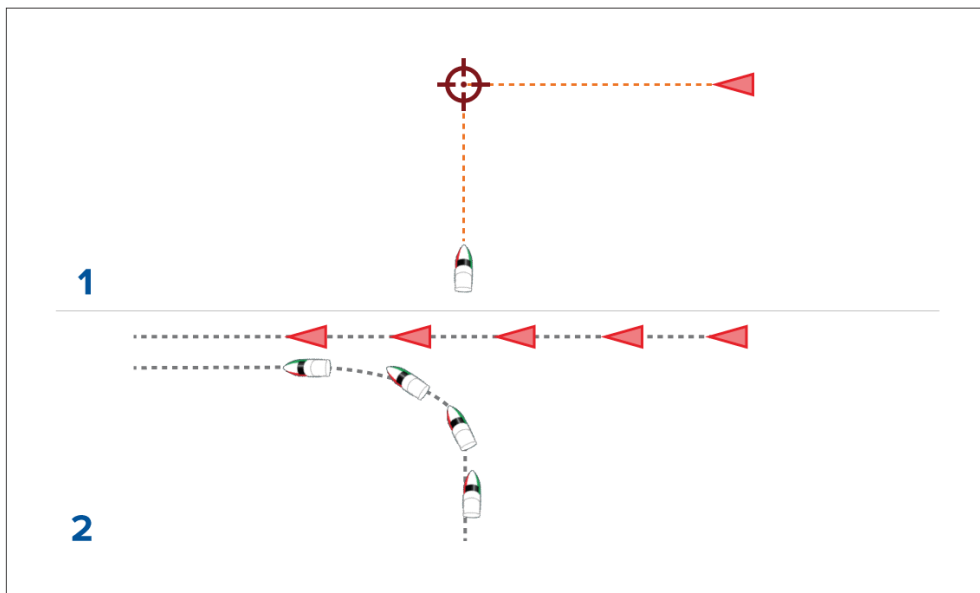

1. Initial Target interception graphics.
2. Actual vessel movements required to perform the rendezvous.

13.12 Reeds almanac

The Reeds almanac is available on Raymarine LightHouse charts.

The Reeds almanac covers Portugal, Spain, France, Germany, Netherlands, Denmark, Ireland/Great Britain.

Reeds marinas are only available in Ireland / Great Britain.

The Reeds symbols are displayed in the Chart app when the *[Streets & POI]* layer is enabled: *[Chart app > Menu > Settings > Layers > Street & POI]*.



Selecting a Reeds symbol will display a pop-up with brief details. Selecting the pop-up displays the full details and any related images. Selecting images will open the image fullscreen

13.13 Find nearest

The Find nearest feature allows you to select a target or location and search for nearby objects or places.

Note:

- The level of detail available on charts is dependent on vendor, chart type, subscription level and geographic region. Prior to purchasing charts check the vendor's website to establish what level of detail is available on the charts you want to purchase.
- The information relating to available chart detail and settings in this manual should be treated as guidance only as it is subject to change that is not under Raymarine's control.

When an object is selected, the *[Nearby objects]* option is available from the object context menu.

Object selection find nearest



Selecting *[Nearby objects]* and then *[Find Nearest]* will display the Find nearest options page where you can select the type of place or object you want to search for.

Selecting an option will display a list of all nearby objects for that type. The list is sorted by an object's proximity to the selected location. However, the Range and Bearing displayed is relative to your vessel's position.

Location selection find nearest

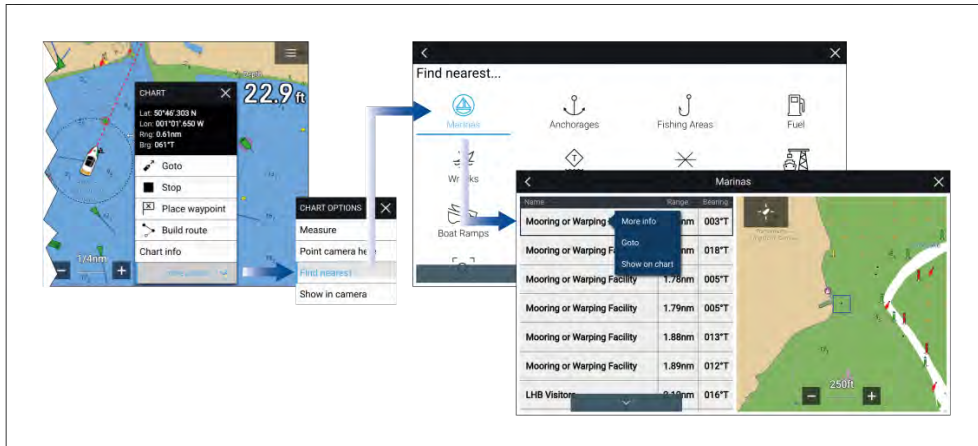

Pressing and holding on a location will open the Chart context menu, selecting *[more options]* and then *[Find nearest]* will display the Find nearest options page where you can select the type of place or object you want to search for.

Selecting an option will display a list of all nearby objects for that type. The list is sorted by an object's proximity to the selected location. However, the Range and Bearing displayed is relative to your vessel's position.

Find nearest options

Note:

Legacy LightHouse Charts refers to retired LightHouse vector, raster and NC2 Charts.

The options available on the find nearest page depend on the cartography type you are using:

- *[Marinas]* (LightHouse Charts, Navionics and C-Map)
- *[Anchorage]* (LightHouse Charts)
- *[Fishing Areas]* (LightHouse Charts)
- *[Fuel]* (LightHouse Charts)
- *[Wrecks]* (LightHouse Charts, Legacy LightHouse Charts, Navionics and C-Map)
- *[Tides]* (Legacy LightHouse Charts, Navionics and C-Map)
- *[Currents]* (Legacy LightHouse Charts, Navionics and C-Map)
- *[Lakes]* (Navionics and C-Map)
- *[Obstructions]* (LightHouse Charts, Legacy LightHouse Charts, Navionics and C-Map)
- *[Ports/Services]* (LightHouse Charts, Navionics and C-Map)
- *[Boat Ramps]* (LightHouse Charts)
- *[Food & Drink]* (LightHouse Charts)
- *[Toilets]* (LightHouse Charts)
- *[Beach/Swim/Recreation]* (LightHouse Charts)
- *[Search for port]* (LightHouse Charts, Legacy LightHouse Charts, Navionics, C-Map)
- *[Small Craft Facility]* (Legacy LightHouse Charts)
- *[Harbor Facility]* (Legacy LightHouse Charts)
- *[Businesses]* (Navionics)
- *[Point of interest]* (C-Map)
- *[Outdoor Recreational Areas (ORA)]* (C-Map)

- *[ORA Services]* (C-Map)

List options

From the list of found objects or places the following pop-over options are available for each item in the list:

- View more information about the object by selecting *[More info]*.
- Navigate to the selected object by selecting *[Goto]*.
- Create an automatic route to the selected object by selecting *[Autoroute to]*, if available.
- Display the selected object in the Chart app by selecting *[Show on chart]*.

When an item from the list is selected the *[LiveView]* on the right of the screen will highlight and zoom to the selected object.

13.14 Measure

The Measure feature can be used to measure distances from your vessel or distances between 2 points.

The measure feature is available from the Chart context menu: *[Context menu > more options > Measure]*.



1. Point to point ruler.
2. Vessel to point ruler.

Multiple rulers can be created and displayed simultaneously.

Measuring vessel to point

To measure the distance and bearing of a location from your vessel's location follow the steps below.

1. Select (press and hold) on the required location.
The context menu is displayed.
2. Select *[more options]*.
3. Select *[Measure]*.
4. Select *[Measure -from boat]* from the pop-over options.

A ruler line is drawn on the screen from your vessel's location to the cursor's location. The distance and bearing from your vessel is also displayed in an information box.

5. If you would like to keep the ruler line select *[Keep ruler]* from the top of the screen.

The ruler will be permanently displayed onscreen, the vessel end of the ruler will move with your vessel updating distance and bearing as you travel.

6. If you do not want to keep the ruler select *[Exit]* from the top of the screen and select *[Discard]* from the confirmation dialog.

Measuring point to point

To measure the distance between 2 points and bearing to the first point follow the steps below.

1. Select (press and hold) any location on the screen.
The context menu is displayed.
2. Select *[more options]*.
3. Select *[Measure]*.
4. Select *[Measure between points]* from the pop-over options.
5. Select the location for the first point.
6. Select the location for the second point.
7. If you would like to keep the ruler line select *[Keep ruler]* from the top of the screen.

The ruler will be permanently displayed onscreen.

- If you do not want to keep the ruler select *[Exit]* from the top of the screen and select *[Discard]* from the confirmation dialog.

Deleting rulers

You can delete individual rulers or all rulers at the same time.

- Select (press and hold) on a ruler point.
- Select *[Delete ruler]* from the context menu.

Alternatively you can delete all rulers by selecting *[Remove all rulers]* from the context menu.

13.15 ClearCruise™ Augmented Reality

The Chart app has additional Augmented Reality features, which are available when an AR200 and a compatible IP camera are connected.

Augmented Reality features must also be enabled and configured in the Video app.

With the Augmented Reality features enabled, the AIS Target, Waypoint and Chart Object data available in the Chart app will also be available in the video app, where the data will be overlaid onto the live video feed.

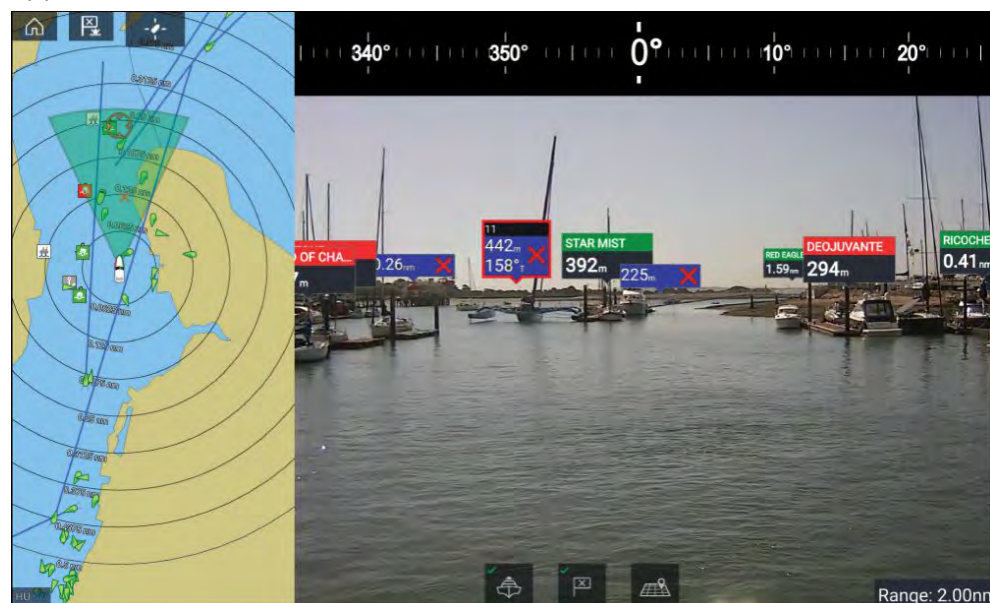

For further information on ClearCruise™ Augmented Reality, refer to [p.457 – ClearCruise features](#).

Field of View

The Field of View (FOV) cone acts as a range indicator to illustrate the area of coverage of the camera with respect to displaying chart objects in the Video app as part of the ClearCruise™ Augmented Reality features.

Chart objects that are within the scope of the displayed FOV cone will be displayed in the Video app as “flags”. For more information on flags, refer to [p.463 – Augmented Reality flags](#)

The area of coverage of the FOV cone is determined by:

- The camera’s horizontal Field of View (FOV). This setting can be adjusted in the Video app: *[Video settings > Camera Setup tab]*.
- The Augmented Reality Range Limit. For more information refer to: [p.466 – Range limit](#) You can also manually specify the maximum range limit. When you adjust this setting, the FOV cone in the Chart app will change accordingly. For more information, refer to: [p.466 – ClearCruise settings \(Augmented Reality\)](#)



The FOV cone can be enabled/disabled in the Chart app settings: *[Menu > Settings > Layers]*.

13.16 Chart settings menu

The chart settings menu is organized into tabs with settings and options appearing under the relevant tab. The settings available in the chart settings menu are dependent on chart mode and the cartography in use.

Note:

- The level of detail available on charts is dependent on vendor, chart type, subscription level and geographic region. Prior to purchasing charts check the vendor's website to establish what level of detail is available on the charts you want to purchase.
- The information relating to available chart detail and settings in this manual should be treated as guidance only as it is subject to change that is not under Raymarine's control.

The following settings tabs are available:

- *[Cartography]*— For details refer to: [p.243 – Cartography settings menu](#)
- *[Layers]*— For details refer to: [p.244 – Layers settings menu](#)
- *[Depth]*— For details refer to: [p.247 – Depth settings menu](#)
- *[View & Motion]*— For details refer to: [p.249 – View & motion settings menu](#)
- *[Advanced]*— For details refer to: [p.250 – Advanced settings menu](#)
- *[Page settings]*— For details refer to: [p.251 – Page settings menu](#)

Weather mode specific settings menus

The following settings menus are only available in weather mode:

- *[Weather]*— For details refer to: [p.272 – Weather settings menu](#)
- *[Subscription]*— For details refer to: [p.272 – Weather subscription](#)

Fish mapping mode specific settings menus

The following settings menu are only available in fish mapping mode:

- *[Fish Mapping]*— For details refer to: [p.261 – Fish mapping subscription](#)

Sailing specific settings menus

The following settings menus are only available in racing and navigate modes when sailing has been selected as the boating activity during the initial start up wizard:

Chart app - General

- *[Laylines]*— For details refer to: [p.286 – Laylines](#)

Cartography settings menu

The cartography settings menu provides settings and details relating to your electronic charts.

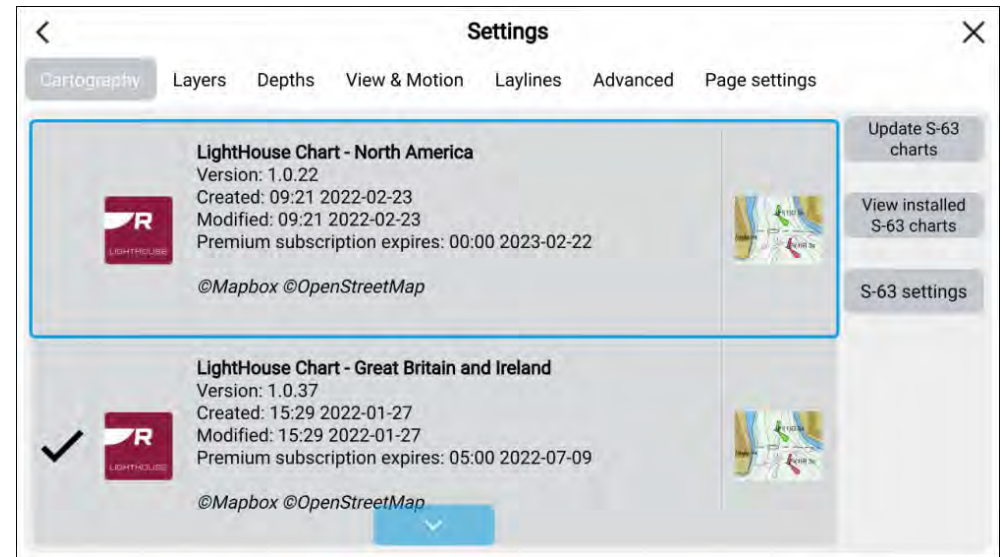

The cartography settings menu provides details of available electronic charts, and allows you to select which electronic charts are used in the current chart app instance.

For details about electronic charts and which charts are compatible with your MFD, refer to: [p.202 – Cartography overview](#)

The cartography settings menu also provides settings for S-63 encrypted charts. For details refer to: [p.206 – S-63 Encrypted Charts](#)

Related topics:

- [p.202 — Cartography overview](#)
- [p.253 — Navigate mode settings menus](#)
- [p.256 — Fishing chart mode settings menus](#)
- [p.284 — Anchor mode settings menus](#)
- [p.286 — Racing mode settings menus](#)
- [p.261 — Fish mapping mode settings menus](#)
- [p.272 — Weather mode settings menus](#)
- [p.280 — Tides mode settings menus](#)

Layers settings menu

The layers setting menu contains settings related to the level of cartographic detail, cartography style and available layers that can be overlaid onscreen. The options that are available depend on the cartography in use and the hardware connected to your MFD's network (e.g.: Radar scanner AIS receiver etc.)

Menu item and description	Options
<i>[Chart detail:]</i> Allows you to select the level of detail displayed onscreen for vector based cartography. This setting is available when using LightHouse™, Legacy LightHouse™, C-MAP® and Navionics® charts.	<ul style="list-style-type: none">• <i>Low</i>• <i>Medium</i>• <i>High</i>
<i>[Chart Object Size]</i> Adjust the display size of chart objects. This setting is available when using LightHouse™ charts and S-63 charts.	Slider bar control.
<i>[Day color palette]</i> When enabled, <i>[Bright sun]</i> provides a darker color palette in the Chart app which is more easily readable in bright sunlight. This setting is available when using LightHouse™ charts.	<ul style="list-style-type: none">• <i>On</i>• <i>Off</i>
<i>[Chart style]</i> Switches between chart presentation styles. This setting is available when using LightHouse™ charts.	<ul style="list-style-type: none">• <i>Leisure</i>• <i>Government</i>

Menu item and description	Options
<i>[AIS]</i> Enables and disables the display of AIS targets in the Chart app. Note: AIS hardware is required. This setting is always available and not dependent on the charts in use.	<ul style="list-style-type: none">• <i>On</i>• <i>Off</i>
<i>[Radar]</i> Enables and disables the display of a Radar overlay in the Chart app. Note: Radar hardware is required. This setting is always available and not dependent on the cartography in use.	<ul style="list-style-type: none">• <i>On</i>• <i>Off</i>
<i>[Range rings]</i> Enables and disables the display of Radar style range rings in the Chart app. This setting is always available and not dependent on the cartography in use.	<ul style="list-style-type: none">• <i>On</i>• <i>Off</i>

Menu item and description	Options
<p><i>[FOV:]</i> Enables and disables the ClearCruise™ Augmented Reality (AR) camera's field of view (FOV) overlay in the Chart app.</p> <p>Note: ClearCruise enabled camera is required.</p> <p>This setting is always available and not dependent on the charts in use.</p>	<ul style="list-style-type: none"> • <i>On</i> • <i>Off</i>
<p><i>[Weather Radar]</i> Enables Weather Radar precipitation data overlay in the Chart app.</p> <p>Note: Only available when connected to a compatible SiriusXM weather receiver with a valid subscription.</p> <p>This setting is always available and not dependent on the charts in use.</p>	<ul style="list-style-type: none"> • <i>On</i> • <i>Off</i>
<p><i>[Tides]</i> Enables and disables display of Tide and Current graphics at tide and current stations. This setting is available when using Navionics® charts.</p>	<ul style="list-style-type: none"> • <i>On</i> • <i>Off</i>
<p><i>[Streets & POI]</i> Enables and disables the display of enhanced street details and point of interest in the Chart app. This setting is available when using LightHouse™ charts with a valid premium subscription.</p>	<ul style="list-style-type: none"> • <i>On</i> • <i>Off</i>
<p><i>[Rudder bar]</i> Enables and disables display of rudder bar indicator. For details refer to: p.218 — Rudder bar indicator This setting is always available and not dependent on the charts in use.</p>	<ul style="list-style-type: none"> • <i>On</i> • <i>Off</i>

Menu item and description	Options
<p><i>[Wind shift bar]</i> Enables and disables display of the wind shift bar indicator. The Wind shift bar is available when <i>Sailing</i> has been selected as the boating activity during the initial display start up wizard. The setting is enabled automatically when switching to the <i>Racing</i> chart mode. For details refer to: p.293 — Wind shift bar</p>	<ul style="list-style-type: none"> • <i>On</i> • <i>Off</i>
<p><i>[AIS PAD]</i> Enables the Predicted Area of Danger graphics for AIS targets. Only available when the AIS layer is enabled.</p> <p>Note: For more information about the collision avoidance feature refer to p.231 — Predicted areas of danger</p> <p>This setting is always available and not dependent on the charts in use.</p>	<ul style="list-style-type: none"> • <i>On</i> • <i>Off</i>
<p><i>[Radar PAD]</i> Enables the Predicted Area of Danger graphics for Radar targets. Only available when the Radar layer is enabled.</p> <p>Note: For more information about the collision avoidance feature, refer to p.231 — Predicted areas of danger</p> <p>This setting is always available and not dependent on the charts in use.</p>	<ul style="list-style-type: none"> • <i>On</i> • <i>Off</i>

Menu item and description	Options
<i>[Aerial overlay]</i> Enables and disables display of a photographic aerial overlay. This setting is available when using LightHouse™ and C-MAP® charts.	<ul style="list-style-type: none"> • <i>On</i> • <i>Off</i>
<i>[Navionics overlays]</i> Enables and disables the display of a photographic aerial overlay when using .Navionics® charts.	<ul style="list-style-type: none"> • <i>None</i> • <i>Satellite</i> • <i>Relief Shading</i> • <i>SonarChart Shading</i>
<i>[Visibility]</i> Allows you to select the transparency of the aerial overlay layer. This setting is available when using LightHouse™, Navionics® and C-MAP® charts.	<ul style="list-style-type: none"> • <i>0% to 100%</i>
<i>[Coverage]</i> Allows you to select the coverage of the aerial overlay. This setting is available when using LightHouse™ and Navionics® charts.	<ul style="list-style-type: none"> • <i>Land</i> • <i>Land and sea</i> • ⁽¹⁾<i>Land and shallow</i>
Note: (1) Navionics® charts only.	
SIRIUS XM In Fishing chart mode when using a SiriusXM receiver with a valid subscription, layer options will be available. For details, refer to: p.256 — SiriusXM layer options	
<i>[EasyView]</i> Enables and disables the magnification of useful icons and text, making them easier to read. This setting is available when using Navionics® charts.	<ul style="list-style-type: none"> • <i>On</i> • <i>Off</i>
<i>[Community edits]</i> Enables and disables the display of crowd-sourced data. This setting is available when using Navionics® charts.	<ul style="list-style-type: none"> • <i>On</i> • <i>Off</i>

Menu item and description	Options
<i>[High res bathy]</i> Enables and disables the display of High Resolution Bathymetry charts, which provide improved bottom detail, contours and structure. This setting is available when using C-MAP® charts.	<ul style="list-style-type: none"> • <i>On</i> • <i>Off</i>
<i>[Sports fishing]</i> Allows you to display easy-to-use information pages about fishing locations including fish type, size, depth, and reef and bottom composition. This setting is available when using C-MAP® charts.	<ul style="list-style-type: none"> • <i>On</i> • <i>Off</i>
<i>[Marine protected areas]</i> Allows clear identification of areas where commercial and recreational fishing is prohibited or restricted. This setting is available when using C-MAP® charts.	<ul style="list-style-type: none"> • <i>On</i> • <i>Off</i>
<i>[Fishing AOI]</i> Enables and disables the display of Fishing AOIs (Areas Of Interest). This setting is available when using LightHouse™ and C-MAP® charts.	<ul style="list-style-type: none"> • <i>On</i> • <i>Off</i>
<i>[ActiveCaptain]</i> Enables and disables the display of crowd-sourced data. This setting is available when using C-MAP® charts.	<ul style="list-style-type: none"> • <i>On</i> • <i>Off</i>

Related topics:

- [p.253 — Navigate mode settings menus](#)
- [p.256 — Fishing chart mode settings menus](#)
- [p.284 — Anchor mode settings menus](#)
- [p.286 — Racing mode settings menus](#)

Depth settings menu

The depth settings menu contains depth contour related settings.

Menu item and description	Options
<p><i>[Show soundings]</i> Enables and disables the display of depth soundings on the chart. When set to <i>[Manual]</i>, depth soundings will be shown from <i>[Zero to]</i>the maximum depth you specify. This setting is not available for Raster charts</p>	<ul style="list-style-type: none"> • <i>None</i> • <i>Manual</i> • <i>All</i>
<p><i>[Show contours]</i> Enables and disables the display of depth contours on the chart. When set to <i>Manual</i>, contours will be shown from zero to the maximum depth you specify. This setting is available when using LightHouse™, C-MAP® and Navionics® vector charts.</p>	<ul style="list-style-type: none"> • <i>None</i> • <i>Manual</i> • <i>All</i>
<p><i>[Shallow contour]</i> Determines the depth at which the Shallow contour is displayed. The Shallow contour cannot be set to a value greater than the Safe contour or Deep contour value. This setting is available when using LightHouse™, legacy LightHouse™ and S-63 vector charts.</p>	Numeric depth value
<p><i>[Safe contour]</i> Determines the depth at which the Safe contour is displayed. The Safe contour cannot be set to a value that is less than the Shallow contour or greater than the Deep contour. This setting is available when using LightHouse™, legacy LightHouse™ and S-63 vectors charts.</p>	Numeric depth value
<p><i>[Shallow area]</i> Enables and disables identification of areas deemed to be shallow. When enabled, a red hatched area is displayed in areas shallower than the depth specified in the <i>[Zero to]</i>field. This setting is available when using Navionics® charts.</p>	<ul style="list-style-type: none"> • <i>On</i> • <i>Off</i>

Menu item and description	Options
<p><i>[Deep contour:]</i> Determines the depth at which the deep contour is shown. E.g. if you set this to a value of 30 meters, any water with a depth greater than 30 meters will be displayed as a deep contour. This setting is not available for Raster charts.</p>	Numeric depth value
<p><i>[Depth gradient]</i> Allows you to specify the gradient shade between shallow and deep. This setting is available when using LightHouse™ and legacy LightHouse™ vector charts.</p>	<ul style="list-style-type: none"> • <i>Dark to light</i> • <i>Light to dark</i>
<p><i>[Deep water color]</i> Allows you to specify the color that will be used to display Deep water. This setting is available when using C-MAP® and Navionics® charts.</p>	<ul style="list-style-type: none"> • <i>White</i> • <i>Blue</i>
<p><i>[Record depth data]</i> Enables depth and position data to be recorded to a MicroSD memory card. This setting is available when using LightHouse™ and legacy LightHouse™ vector charts.</p>	<ul style="list-style-type: none"> • <i>On</i> • <i>Off</i>
<p><i>[Waterline to tdc]</i> Enter the distance between the waterline and your depth transducer. This setting is available when using LightHouse™ and legacy LightHouse™ vector charts.</p>	Numeric depth value
<p><i>[Save to]</i> When a suitable MicroSD card has been inserted, the free space available for recording depth data and RealBathy is displayed. This setting is available when using LightHouse™ and legacy LightHouse™ vector charts.</p>	<ul style="list-style-type: none"> • <i>SD1</i> • <i>SD2</i>
<p><i>[RealBathy]</i> Displays on the chart previously recorded RealBathy™ data saved to a MicroSD memory card. This setting is available when using LightHouse™ and legacy LightHouse™ vector charts.</p>	<ul style="list-style-type: none"> • <i>On</i> • <i>Off</i>

Menu item and description	Options
<i>[Visibility]</i> Determines the transparency of the RealBathy data displayed onscreen. This setting is available when using LightHouse™ and legacy LightHouse™ vector charts.	<ul style="list-style-type: none"> • 0% to 100%
<i>[Height correction]</i> Determines the level of height correction applied to RealBathy and depth data. This setting is available when using LightHouse™ and legacy LightHouse™ vector charts.	<ul style="list-style-type: none"> • None • Tidal • Lake level
<i>[Density]</i> Selects the density of available depth contours. This setting is available when using LightHouse™ and legacy LightHouse™ vector charts.	<ul style="list-style-type: none"> • Low • Medium • High • Very high
<i>[Sonar logging]</i> Allows logging of depth and position data to your Navionics chart card. This setting is available when using Navionics® charts.	<ul style="list-style-type: none"> • On • Off
<i>[SonarChart Live]</i> Enables and disables the Navionics SonarChart Live feature, which enables the realtime creation and display of high resolution bathymetry charts. When set to <i>[History]</i> , historical sonar chart live data is displayed. This setting is available when using Navionics® charts.	<ul style="list-style-type: none"> • On • Off • History
<i>[Visibility]</i> Determines the level of transparency used when displaying SonarChart data. This setting is available when using Navionics® charts.	<ul style="list-style-type: none"> • 0% to 100%
<i>[Tide correction]</i> Enables sonar logging depth measurements to be offset by tide height data from nearby tide stations. Tide correction will be disabled when viewing historical SonarChart Live data. This setting is available when using Navionics® charts.	<ul style="list-style-type: none"> • On • Off

Menu item and description	Options
<i>[Shallow depth shading]</i> Enables and disables the identification of areas deemed to be shallow. When set to On, a red hatched area is displayed in areas shallower than the specified depth. This setting is available when using Navionics® charts.	<ul style="list-style-type: none"> • On • Off
<i>[Density]</i> Determines the density of available depth contours. This setting is available when using Navionics® charts.	<ul style="list-style-type: none"> • Very high • High • Medium • Low
<i>[Fishing Zone]</i> You can set up a Fishing Range by enabling <i>[Fishing Zone]</i> and specifying a minimum and maximum depth. Areas on the chart that are between these depths will be colored White; areas outside of these depths will be colored Blue. This setting is available when using Navionics® charts.	<ul style="list-style-type: none"> • On • Off

Related topics:

- [p.253 — Navigate mode settings menus](#)
- [p.256 — Fishing chart mode settings menus](#)
- [p.284 — Anchor mode settings menus](#)
- [p.286 — Racing mode settings menus](#)

View & motion settings menu

The view and motion settings menu contains settings that allow you to control how the chart is displayed in relation to your vessel.

Menu item and description	Options
<p><i>[Chart motion]</i></p> <p>Relative motion In Relative motion mode the vessel icon remains fixed onscreen and the chart area moves relative to your position. In this mode you can adjust your vessel's fixed position using the Boat position setting.</p> <p>True motion In True motion mode the chart is fixed and your vessel icon moves around the chart. As your vessel's position reaches the edge of the screen, the chart is redrawn to reveal the area in front of your vessel.</p> <p>Auto range In Auto range the largest possible scale is maintained that will display both your vessel and the destination / target waypoint simultaneously.</p>	<ul style="list-style-type: none"> • <i>Relative motion</i> • <i>True motion</i> • <i>Auto range</i>
<p><i>[Chart orientation]</i></p> <p>North-up In North-up the top of the screen always points towards north. As your vessel's heading changes, the vessel icon rotates accordingly.</p> <p>Head-up In Head-up the top of the screen always points towards your vessel's current heading, and as your heading changes the chart rotates accordingly.</p> <p>Course-up In Course-up the top of the screen always points towards your destination, and as your destination changes the chart rotates accordingly.</p>	<ul style="list-style-type: none"> • <i>North-up</i> • <i>Head-up</i> • <i>Course-up</i>

Menu item and description	Options
<p><i>[Boat position]</i> The boat position determines the position of your vessel icon onscreen. The default is Center but you can adjust this to provide a greater distance in front of your vessel. Your boat position can only be changed when Chart motion is set to Relative motion.</p>	<ul style="list-style-type: none"> • <i>Center</i> • <i>Partial offset</i> • <i>Full offset</i>
<p><i>[Sync view with other charts:]</i> All charts with <i>[Sync]</i> turned <i>[On]</i> will synchronize orientation and position.</p>	<ul style="list-style-type: none"> • <i>On</i> • <i>Off</i>

Related topics:

- [p.253 — Navigate mode settings menus](#)
- [p.256 — Fishing chart mode settings menus](#)
- [p.284 — Anchor mode settings menus](#)
- [p.261 — Fish mapping mode settings menus](#)
- [p.286 — Racing mode settings menus](#)

Advanced settings menu

The advanced setting menu contains advanced settings related to the chart app's user interface, and determines which cartographic objects are displayed and the appearance of the chart and its data.

Menu item and description	Options
<p><i>[Chart orientation]</i> North-up In North-up the top of the screen always points towards north. As your vessel's heading changes, the vessel icon rotates accordingly. Head-up In Head-up the top of the screen always points towards your vessel's current heading, and as your heading changes the chart rotates accordingly. Course-up In Course-up the top of the screen always points towards your destination, and as your destination changes the chart rotates accordingly.</p>	<ul style="list-style-type: none"> • <i>North-up</i> • <i>Head-up</i> • <i>Course-up</i>
<p><i>[Enhanced AIS targets]</i> Switches between using standard and enhanced AIS targets.</p>	<ul style="list-style-type: none"> • <i>On</i> • <i>Off</i>
<p><i>[Auto find ship]</i> When enabled the Chart app will automatically center to your vessel after 30 seconds.</p>	<ul style="list-style-type: none"> • <i>On</i> • <i>Off</i>
<p><i>[Use Radar without heading data]</i> Enables use of Radar overlay without Heading data.</p>	<ul style="list-style-type: none"> • <i>On</i> • <i>Off</i>
<p><i>[Use SOG for hdg vector length]</i> Enables you to use SOG data to determine the length of the vessel heading vector instead of STW (Speed Through Water).</p>	<ul style="list-style-type: none"> • <i>On</i> • <i>Off</i>
<p><i>[Cursor info boxes]</i> Allows display of information pop-ups for targets and objects.</p>	<ul style="list-style-type: none"> • <i>On</i> • <i>Off</i>
<p><i>[Tide animation interval]</i> Allows you to select the time interval used for the Tide and Current animations in Tides mode.</p>	<ul style="list-style-type: none"> • <i>15 minutes to 2 hours in 15 minute steps.</i>

Menu item and description	Options
<p><i>[Cartographic objects]</i> Enables and disables the display of cartographic objects. The settings available are dependent on the cartography in use.</p>	<ul style="list-style-type: none"> • <i>Navigation marks (1)</i> • <i>Navigation mark symbols (1)</i> • <i>Rocks (2)</i> • <i>Light sectors (1)</i> • <i>Routing systems (3)</i> • <i>Caution areas (1)</i> • <i>Marine features (3)</i> • <i>Land features (4)</i> • <i>Business services (5)</i> • <i>Panoramic photos (5)</i> • <i>Roads (6)</i> • <i>Colored seabed areas (7)</i> • <i>Buoy names (8)</i> • <i>Light desc (8)</i>
<p>Note:</p> <ul style="list-style-type: none"> • (1) Available on Navionics®, C-MAP® and Legacy LightHouse™ charts. • (2) Available on all charts. • (3) Available on Navionics®, C-MAP®, Legacy LightHouse™ and LightHouse™ charts. • (4) Available on Navionics®, C-MAP®, Legacy LightHouse™, LightHouse™ and S-63 charts. • (5) Available on Navionics® and C-MAP® charts. • (6) This setting is always available and not dependent on the cartography in use. • (7) Available on Navionics® charts. • (8) Available on S-63 Encrypted Charts 	

Menu item and description	Options
<p><i>[Chart appearance]</i> Allows you to change the appearance of the Chart app. The settings available are dependent on the cartography in use.</p> <p>Note:</p> <ul style="list-style-type: none"> • (1) Available on Navionics® charts • (2) Available on Navionics® and LightHouse™ charts. • (3) Available on Navionics®, C-MAP® and LightHouse™ charts. • (4) This setting is always available and not dependent on the cartography in use. • (5) Available on Navionics®, C-MAP®, Legacy LightHouse™ and LightHouse™ charts. • (6) Available on C-MAP® and LightHouse™ charts. • (7) Available on Navionics® and C-MAP® charts. 	<ul style="list-style-type: none"> • <i>2D shading</i> (1) • <i>Aerial overlay</i> (2) • <i>Aerial overlay opacity</i> (3) • <i>Relief shading</i> (1) • <i>Grid</i> (4) • <i>Chart text</i> (4) • <i>Chart boundaries</i> (5) • <i>Text/symbol size</i> (6) • <i>Deep water color</i> (7) • <i>Community edits</i> (1)
<p><i>[My data appearance]</i> You can change how your User data appears in the Chart app. This setting is always available and not dependent on the cartography in use.</p>	<ul style="list-style-type: none"> • Waypoints names • Route names • Track names • Route width • Track width • Vector width • Vector length

Related topics:

- [p.253 — Navigate mode settings menus](#)
- [p.256 — Fishing chart mode settings menus](#)
- [p.284 — Anchor mode settings menus](#)
- [p.286 — Racing mode settings menus](#)
- [p.261 — Fish mapping mode settings menus](#)
- [p.272 — Weather mode settings menus](#)
- [p.280 — Tides mode settings menus](#)

Page settings menu

The page settings menu contains settings related to page layout.

The following options are available:

- *[Data Overlays]*— Enables configuration of Data overlays, which overlay key information from connected sensors onto the Chart, Radar, Sonar and Camera apps.
- *[Edit split ratio]*— Enables you to customize the position of the partitions in splitscreen app pages. For example, 50/50, 70/30 etc.

Related topics:

- [p.49 — Data overlays](#)
- [p.253 — Navigate mode settings menus](#)
- [p.256 — Fishing chart mode settings menus](#)
- [p.284 — Anchor mode settings menus](#)
- [p.286 — Racing mode settings menus](#)
- [p.261 — Fish mapping mode settings menus](#)
- [p.272 — Weather mode settings menus](#)
- [p.280 — Tides mode settings menus](#)

CHAPTER 14: CHART APP - NAVIGATE MODE

CHAPTER CONTENTS

- 14.1 Navigate mode — page 253
- 14.2 Navigate mode main menu — page 253
- 14.3 Navigate mode settings menus — page 253

14.1 Navigate mode

Navigate mode is the primary mode that should be used for navigation. Full active navigation and target tracking features are available and navigational contours, soundings and objects will be displayed onscreen when using appropriate cartography.

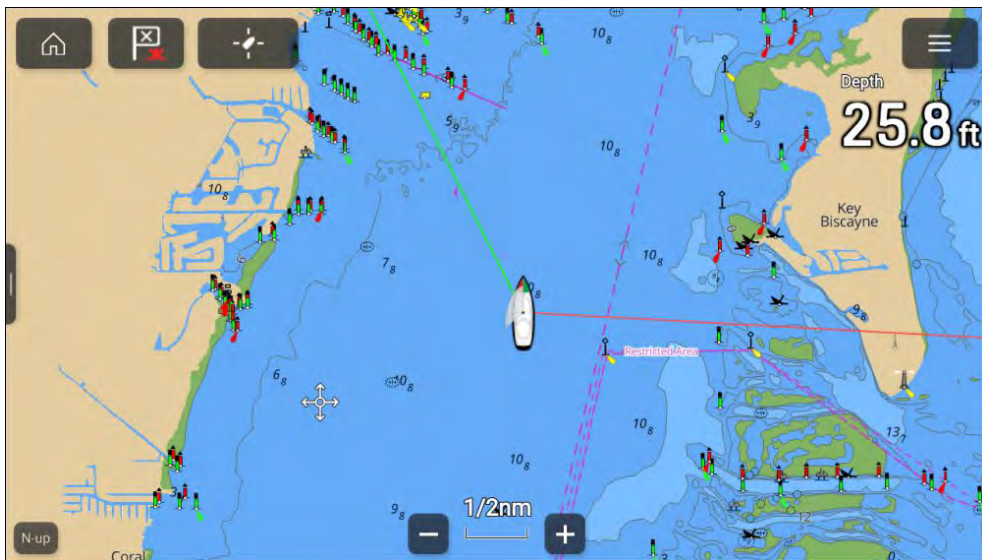

14.2 Navigate mode main menu

Navigate mode includes the relevant menu items for safe navigation.

The following options are available from the main menu:

- *[Find ship]*— The find ship icon will be available in the main menu and as an onscreen icon anytime that your vessel is not centered in the chart app.
- *[Mode]*— Chart app mode can be changed at any time by selecting a mode. For details of available chart modes refer to: [p.196 — Chart modes](#)
- *[Go]*— Provides options to start active navigation.
- *[New]*— Provides options to create new waypoints, routes, tracks and search patterns.
- *[Waypoints, routes, track]*— Opens the *[My data]* menu to allow access to waypoints, routes and tracks lists. For details refer to: [p.104 — My data](#)

- *[Targets]*— Provides access to target tracking options. For details refer to: [p.223 — Target tracking](#)
- *[Settings]*— Provides access the chart app settings menu. For details refer to: [p.253 — Navigate mode settings menus](#)

14.3 Navigate mode settings menus

The following settings menus are available in navigate mode:

- *[Cartography]*— For details refer to: [p.243 — Cartography settings menu](#)
- *[Layers]*— For details refer to: [p.244 — Layers settings menu](#)
- *[Depth]*— For details refer to: [p.247 — Depth settings menu](#)
- *[View & Motion]*— For details refer to: [p.249 — View & motion settings menu](#)
- *[Laylines]*— The laylines settings menu will be available when the MFD's boating activity is set to *[Sailing]*. For details refer to: [p.286 — Laylines](#)
- *[Advanced]*— For details refer to: [p.250 — Advanced settings menu](#)
- *[Page settings]*— For details refer to: [p.251 — Page settings menu](#)

CHAPTER 15: CHART APP - FISHING CHART MODE

CHAPTER CONTENTS

- 15.1 Fishing chart mode — page 255
- 15.2 Fishing chart mode main menu — page 255
- 15.3 Fishing intel menu — page 255
- 15.4 SiriusXM layer options — page 256
- 15.5 Fishing chart mode settings menus — page 256

15.1 Fishing chart mode

Fishing chart mode optimizes the chart app for fishing. When using supported cartography fishing chart mode will switch to use fishing cartography which provides enhanced bathymetric contours that are not shown in other chart modes.

Important:

It is not recommended that fishing chart mode is used for navigation.

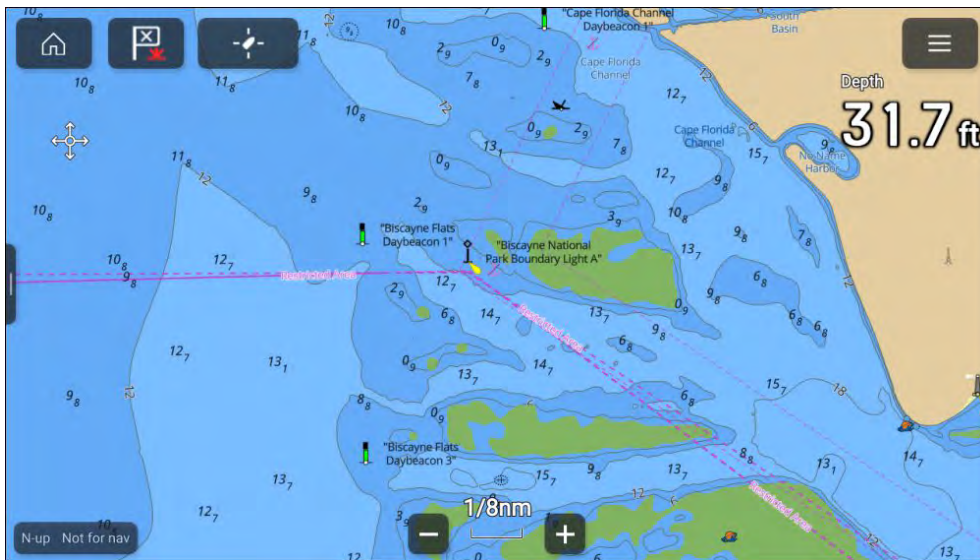

When connected to a compatible SiriusXM receiver the *[Fishing intel]* menu is available which provides access to fishing recommendations and fish mapping layers options. For details refer to: [p.255 — Fishing intel menu](#)

15.2 Fishing chart mode main menu

Fishing chart mode includes menu items related to fishing and navigation.

The following options are available from the main menu:

- *[Find ship]*— The find ship icon will be available in the main menu and as an onscreen icon anytime that your vessel is not centered in the chart app.

- *[Mode]*— Chart app mode can be changed at any time by selecting a mode. For details of available chart modes refer to: [p.196 — Chart modes](#)
- *[Go]*— Provides options to start active navigation.
- *[New]*— Provides options to create new waypoints, routes, tracks and search patterns.
- *[Waypoints, routes, track]*— Opens the *[My data]* menu to allow access to waypoints, routes and tracks lists. For details refer to: [p.104 — My data](#)
- *[Targets]*— Provides access to target tracking options. For details refer to: [p.223 — Target tracking](#)
- *[Fishing intel]*— Provides access to SiriusXM fish mapping options. For details refer to: [p.255 — Fishing intel menu](#)
- *[Settings]*— Provides access the chart app settings menu. For details refer to: [p.256 — Fishing chart mode settings menus](#)

15.3 Fishing intel menu

The *[Fishing intel]* menu provides access to SiriusXM options.

The following fish mapping options are available:

- *[Fish Mapping Layers]*— For details of available fish mapping layers refer to: [p.260 — Fish mapping layers](#)
- *[Fishing Recommendations]*— For details of available fishing recommendation layers refer to: [p.259 — Fishing recommendations](#)
- *[SST]* (Sea surface temperature)

Sea surface temperature menu

SiriusXM sea surface temperature layer options are available from the *[Fishing intel]* menu: *[Menu > Fishing intel > SST]*.

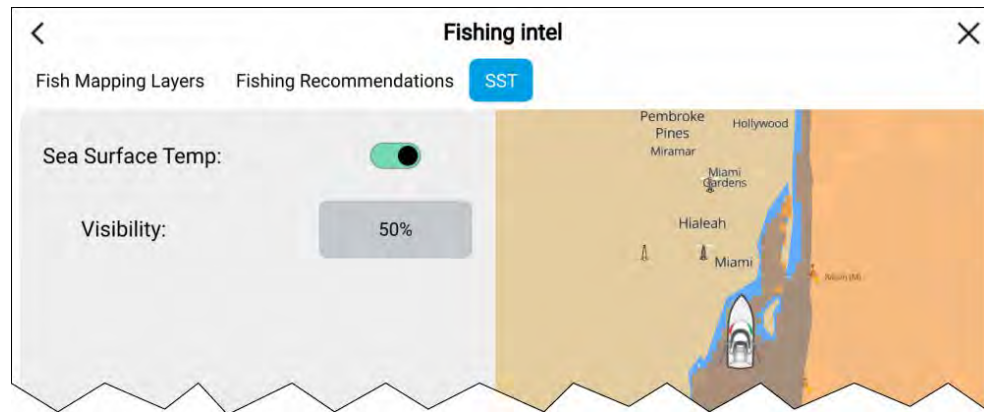

The layer can be enabled and disabled and the transparency can be adjusted using the *[Visibility]* control.

15.4 SiriusXM layer options

In fishing chart mode SiriusXM related layer options are grouped together in the *[Layers]* settings menu.

The following options are available:

- *[Weather Radar]*— Enables and disables the Sirius weather radar layer.
- *[Weather visibility]*— Determines the transparency of the weather radar layer.
- *[Sea surface temps]*— Enables and disables the Sirius sea surface temperature layer.
- *[SST visibility]*— Determines the transparency of the sea surface temperature layer.
- *[Fish Mapping]*— Selecting *[Configure]* opens the *[Fishing intel]* menu.
- *[Show legend]*— Enabled and disables display of the fish mapping legend onscreen.

15.5 Fishing chart mode settings menus

The following settings menus are available in fish chart mode:

- *[Cartography]*— For details refer to: [p.243 — Cartography settings menu](#)
- *[Layers]*— For details refer to: [p.244 — Layers settings menu](#)
- *[Depth]*— For details refer to: [p.247 — Depth settings menu](#)
- *[View & Motion]*— For details refer to: [p.249 — View & motion settings menu](#)
- *[Advanced]*— For details refer to: [p.250 — Advanced settings menu](#)
- *[Page settings]*— For details refer to: [p.251 — Page settings menu](#)

CHAPTER 16: CHART APP - FISH MAPPING MODE

CHAPTER CONTENTS

- [16.1 Fish mapping mode — page 258](#)
- [16.2 Fish mapping mode main menu — page 259](#)
- [16.3 Fishing recommendations — page 259](#)
- [16.4 Fish mapping layers — page 260](#)
- [16.5 Layer / fish type identification — page 260](#)
- [16.6 Limiting data display limits — page 261](#)
- [16.7 Fish mapping subscription — page 261](#)
- [16.8 Fish mapping mode settings menus — page 261](#)

16.1 Fish mapping mode

Fish mapping mode is a chart mode that enables you to utilize Sirius XM fishing data in the Chart app. When compatible hardware (e.g.: SR200) is detected, fish mapping mode will be available. Fish mapping mode requires a valid SiriusXM subscription. To find out more about fish mapping data and subscriptions visit the SiriusXM website: <https://siriusxmcommunications.com/fishmapping/#features>

Fish mapping mode overlays fishing layers and fishing recommendation locations on the Chart app.

Important:

- Use of fish mapping mode is subject to acceptance of the disclaimer that is displayed when fish mapping mode is activated. Please read and ensure you understand the disclaimer's conditions.
- Fish mapping mode should NOT be used for navigation. **Contours used for safe navigation and related markings and objects are hidden in fish mapping mode.** Active navigation controls and menus are also not available.
- Fish mapping data is only available in North America and its coastal waters.

To enter fish mapping mode, open the Chart app menu, select *[Mode:]*, and then select the fish mapping icon.

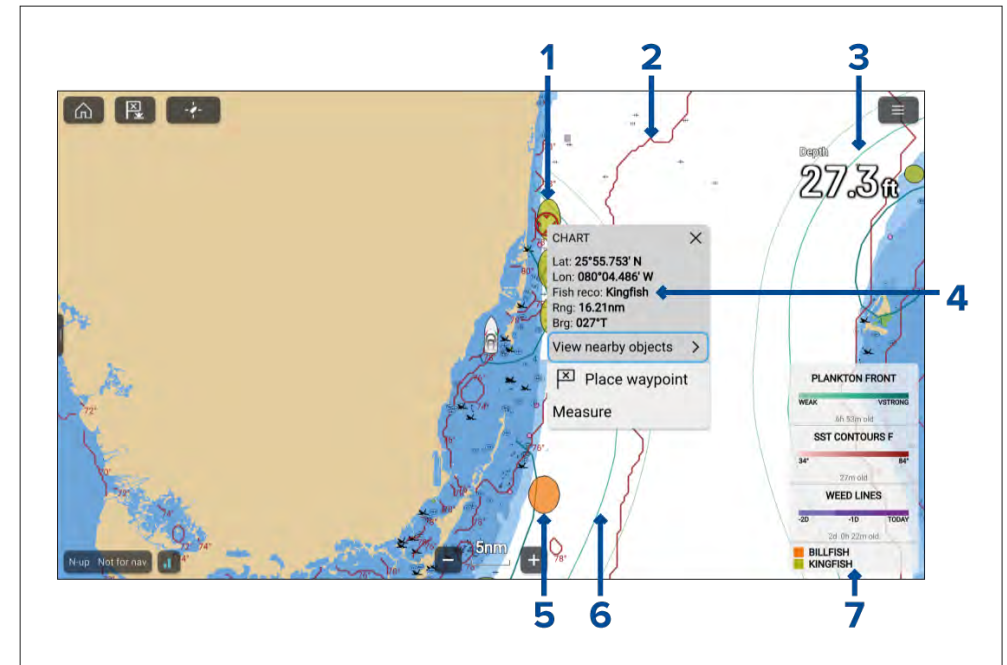

1. Example fishing recommendation — Kingfish location.
2. Example fishing layer — SST contour front.
3. Fishing layer example — Plankton front, weak contour.
4. Example context menu — Fishing recommendation.
5. Example fishing recommendation — Billfish location.
6. Fishing layer example — Plankton front, very strong contour.
7. Fish mapping legend.

Fishing mapping layers and Fishing recommendation layers are also available in the Chart app's Fishing chart mode.

Activating your SiriusXM receiver

Your MFD is compatible with the SR150 and SR200 SiriusXM receivers. Your receiver must be activated before you can use fish mapping mode on your MFD.

The following information is required to activate your SiriusXM receiver:

- Electronic Serial Number (ESN) — The ESN is printed on the product label located on the underside of your SiriusXM receiver. You can also access

the ESN from the *[Fish mapping]* settings menus in the chart app: (*[Menu > Settings > Fish mapping > Receiver ESN]*).

- Current billing information (if you already have a valid subscription).
 - Desired subscription package.
1. Obtain your SiriusXM receiver's ESN.
 2. Visit the Sirius Marine Weather website: SiriusXM fish mapping website: <https://siriusxmcommunications.com/fishmapping/#features>, and choose a subscription package.
 3. Follow the "*[Activate Now]*" link to activate your receiver online. Alternatively, call 1-844-342-0665.

Once your SiriusXM receiver is activated fish mapping mode will be available in the chart app menu.

16.2 Fish mapping mode main menu

Fish mapping mode includes menu items related to fish mapping. Active navigation and target tracking menus such as *[Targets]*, *[Go]* and *[New]* are not available.

The following options are available from the main menu:

- *[Find ship]*— The find ship icon will be available in the main menu and as an onscreen icon anytime that your vessel is not centered in the Chart app.
- *[Mode]*— Chart app mode can be changed at anytime by selecting a mode. For details of available chart modes, refer to: [p.196 — Chart modes](#)
- *[Waypoints, routes, track]*— Opens the *[My data]* menu to allow access to waypoints, routes and track lists. For details refer to: [p.104 — My data](#)
- *[Fishing recommendations]*— Allows you to select which specific fish type layers you want to display. For details refer to: [p.259 — Fishing recommendations](#)
- *[Fish mapping layers]*— Allows you to select which fishing data layers you want to display. For details refer to: [p.260 — Fish mapping layers](#)
- *[Data display limits]*— Allows you to restrict the display data limits for certain fish mapping layers. For details refer to: [p.261 — Limiting data display limits](#)
- *[Animate weed lines]*— Animates the weed line layer.
- *[Show legend]*— Displays an onscreen legend for currently enabled layers.

- *[Settings]*— Provides access to the Chart app settings menu. For details refer to: [p.261 — Fish mapping mode settings menus](#)

You can check when fishing data was last received / updated from the *[Fish Mapping]* settings menu: *[Menu > Settings > Fish Mapping]*.

16.3 Fishing recommendations

Fishing recommendations enable you to view recommended locations that currently have ideal conditions for finding specific fish types. If conditions are not ideal for a selected species then no recommendation will be displayed.

The following fish types can be enabled and disabled from the *[Fishing Recommendations]* menu:

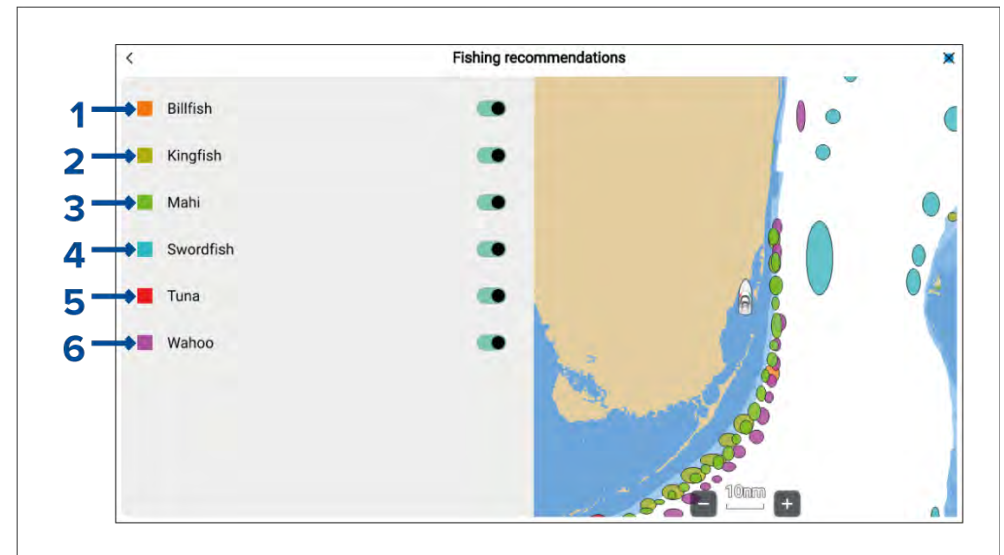

1. *[Billfish]*
2. *[Kingfish]*
3. *[Mahi]*
4. *[Swordfish]*
5. *[Tuna]*
6. *[Wahoo]*

Fishing recommendations are also available in Fishing chart mode. Refer to: Fishing intel menu: [p.255 — Fishing intel menu](#)

16.4 Fish mapping layers

The fish mapping layers allow you to overlay fishing data in the chart app to help you identify the best locations for finding fish.

The following fish mapping layers can be enabled and disabled from the *[Fish mapping layers]* menu:

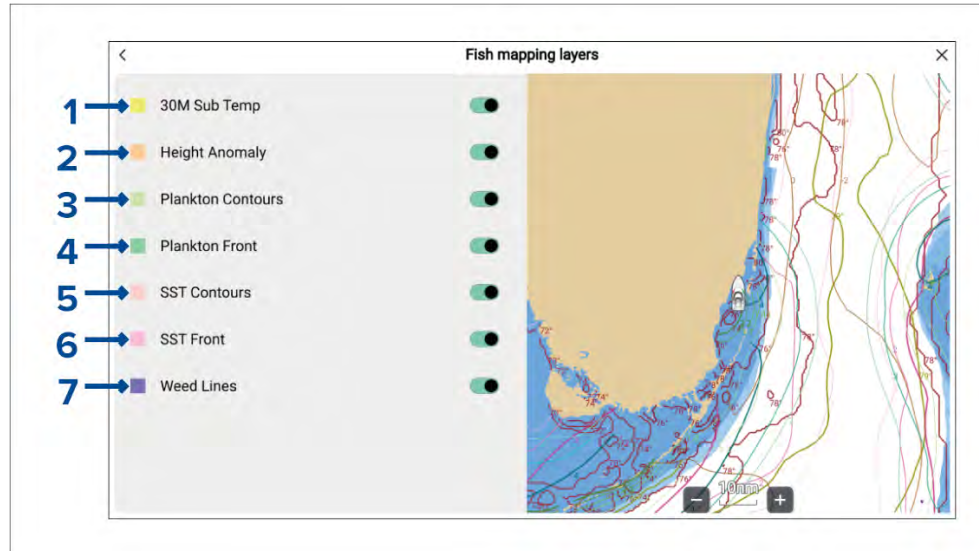

1. *[30M Sub Temp]* (30 metre sub-surface sea temperatures) — View contour lines for bodies of water below the surface temperature range.
2. *[Height Anomaly]* (Sea surface height anomaly) — View contour lines for locations where the sea surface height is different than the surrounding area. The anomalies show where fronts, eddies, upwellings and downwellings are located.
3. *[Plankton Contours]* (Plankton concentration contours) — View contour lines for areas of plankton concentration to help identify favorable conditions.
4. *[Plankton Front]* (Plankton front strength) — View contour lines for areas of strong plankton concentration bordering areas with relatively low or no plankton.
5. *[SST Contours]* (Sea Surface Temperature contours) — View contour lines for sea surface temperatures.

6. *[SST Front]* (Sea Surface Temperature front strength) — View contour lines for areas where there are significant temperature changes which create distinct temperature boundaries between bodies of water.
7. *[Weed Lines]* — View contour lines for locations where floating algae/plants have been sighted recently, or are most likely to be forming. The weed lines contour can be animated using the *[Animate weed lines]* option in the main menu. The weed front line animation can cover a period of up to 3 days (i.e.: today and up to 2 previous days).

Color gradients are used to identify the concentration or strength of the relevant contour e.g.: a darker color for plankton contours indicates a higher concentration of plankton in that area. The legend shows the color gradients used and what they represent.

Fish mapping layers are also available in Fishing chart mode. Refer to: Fishing intel menu: [p.255 — Fishing intel menu](#)

16.5 Layer / fish type identification

The available layers and fish types are identified by different colors.

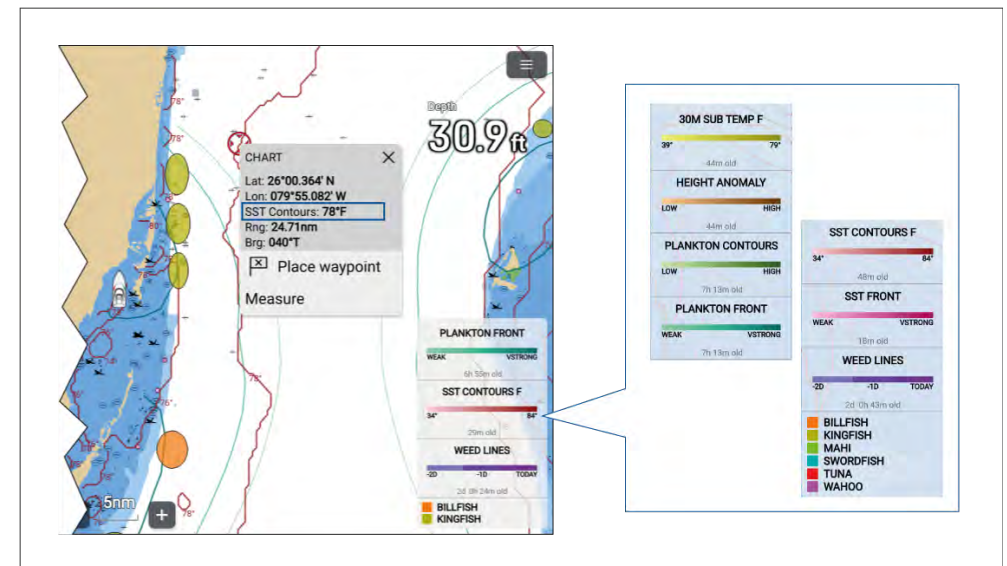

A legend identifying which layers and fish types are currently enabled can be displayed onscreen using the *[Show Legend]* option from the Chart app menu. When several layers/fish types are enabled, you can scroll the legend to see all enabled items.

Layers and fish types can also be selected in the Chart app, and the context menu will identify which layer or fish type has been selected.

16.6 Limiting data display limits

By default the displayed data limits will cover the full range of received data. Upper and lower limits can be specified manually for SST contour, 30M sub surface sea temperature and height anomaly layers.

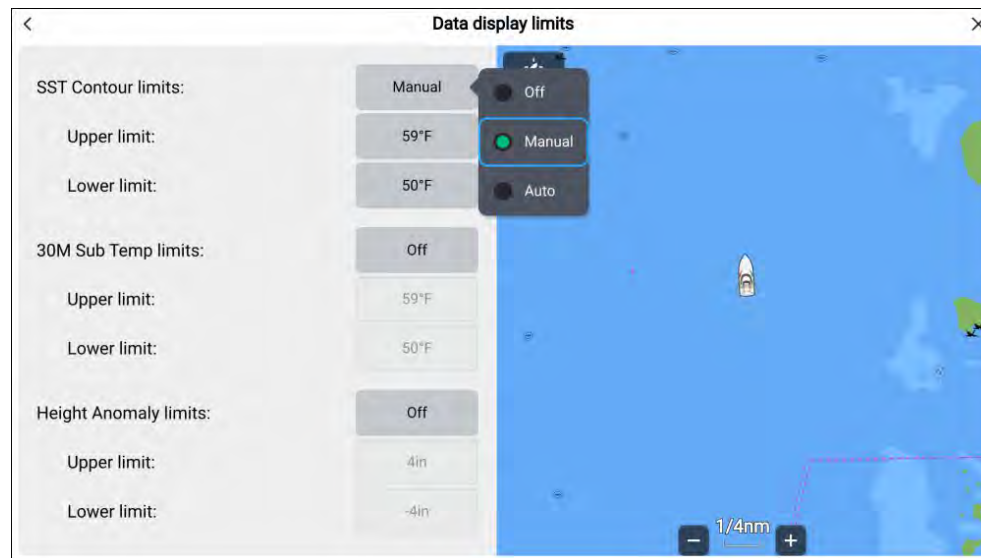

1. Select *[Data display limits]* from the Chart app menu.
2. Select the relevant option field, either *[SST Contour limits]*, *[30M Sub Temp Limits]* or *[Height Anomaly Limits]*.
3. Select *[Manual]* from the pop-over options.
4. Adjust the *[Upper limit]* and *[Lower limit]* fields as required.

The *[Manual]* option will limit the displayed data to the specified range. Setting a data limit option to *[Auto]* will filter the data according to the data limits received by your Sirius receiver.

You can revert to displaying the full range of received data by switching the option to *[Off]*.

When manual limits are applied '**Limits ON**' indication is displayed against the layer in the legend and in the status area at the bottom left of the chart app.

16.7 Fish mapping subscription

You can check your subscription status and data reception from the *[Fish mapping]* settings menu: *[Menu > Settings > Fish mapping]*.

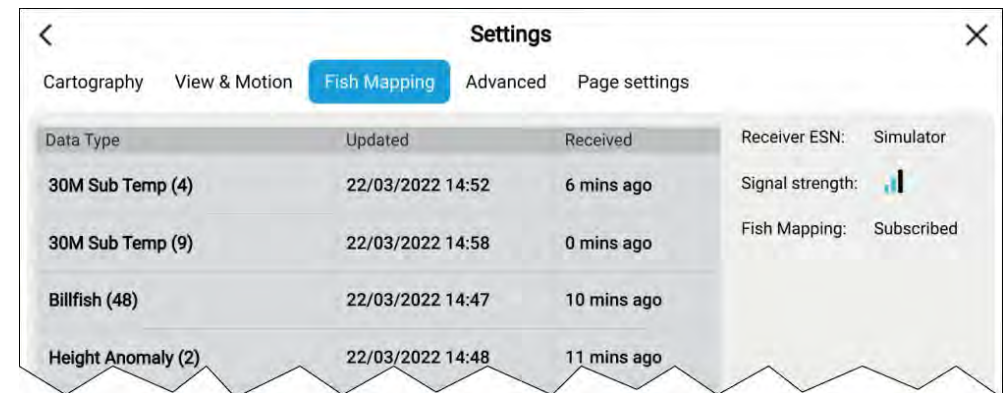

The fish mapping settings menu lists the data types that have been received, and also provides the date and time it was received and last updated.

You can also check your subscription status, and the Sirius receiver's ESN and signal strength.

16.8 Fish mapping mode settings menus

The following settings menus are available in fish mapping mode:

- *[Cartography]* — For details refer to: [p.243 — Cartography settings menu](#)
- *[View & Motion]* — For details refer to: [p.249 — View & motion settings menu](#)
- *[Fish Mapping]* — For details refer to: [p.261 — Fish mapping subscription](#)
- *[Advanced]* — For details refer to: [p.250 — Advanced settings menu](#)
- *[Page settings]* — For details refer to: [p.251 — Page settings menu](#)

CHAPTER 17: CHART APP - WEATHER MODE

CHAPTER CONTENTS

- 17.1 Weather mode — page 263
- 17.2 Weather mode main menu — page 263
- 17.3 Activating your SiriusXM receiver — page 264
- 17.4 Weather layers — page 264
- 17.5 Animated weather — page 265
- 17.6 Weather radar layer — page 266
- 17.7 Cities and Surface observation stations layers — page 267
- 17.8 Cloud top and Lightning layers — page 267
- 17.9 Sea surface temperature and Surface pressure layers — page 268
- 17.10 Storm cast and Storm tracks layers — page 269
- 17.11 Wind and Watchbox layers — page 270
- 17.12 Wave direction, wave height and wave period layers — page 271
- 17.13 Weather mode settings menus — page 272
- 17.14 Weather settings menu — page 272
- 17.15 Weather subscription — page 272
- 17.16 Glossary of weather terms — page 273

17.1 Weather mode

Weather mode allows you to track weather systems in relation to your vessel by overlaying live, historical and forecasted weather data directly on the chart. In weather mode you can also view animated weather graphics and read weather reports. Weather mode is available in the chart app if you have a compatible Sirius weather receiver and valid subscription. Switching the chart app to weather mode allows you to overlay weather data and information from your weather receiver.

Important:

- Use of weather mode is subject to acceptance of the disclaimer that is displayed when weather mode is activated. Please read and ensure you understand the disclaimer's conditions.
- Weather mode should NOT be used for navigation. Contours used for safe navigation and related markings and objects are hidden in weather mode. Active navigation controls and menus are also not available.
- Weather data is only available in North America and its coastal waters.

To enter weather mode, open the chart app menu, select *[Mode:]* and then select the weather icon.

In weather mode the *[Chart orientation]* is fixed in *[North-Up]* mode.

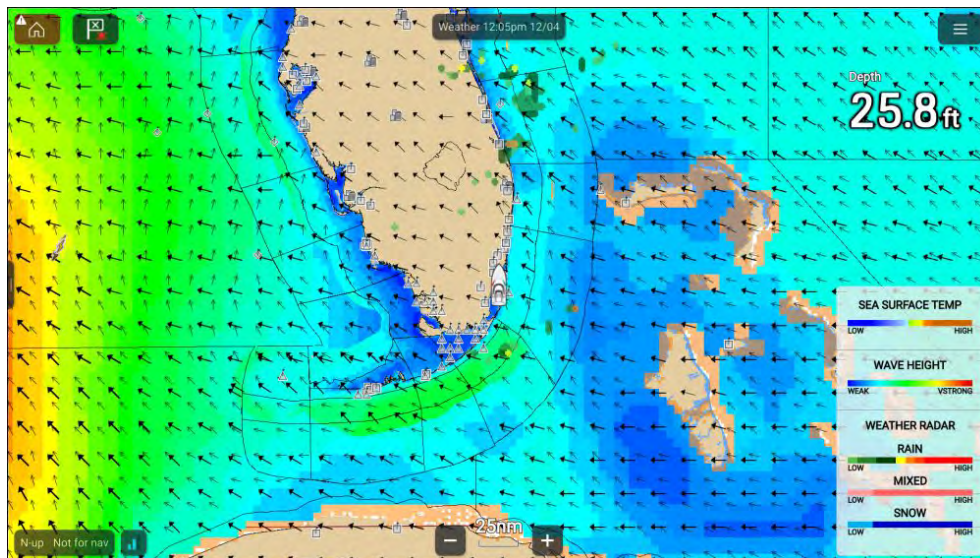

Chart app - Weather mode

Weather symbols are organized into layers, accessible from the chart menu: *[Menu > Weather layers]*. Each layer can be enabled and disabled independently. For details refer to: [p.264 – Weather layers](#)

Weather mode context menu

The Weather mode context menu provides the standard lat/lon and range and bearing information relative to your vessel. The context menu also provides access to weather-related data.

Selecting an area onscreen will open the context menu.

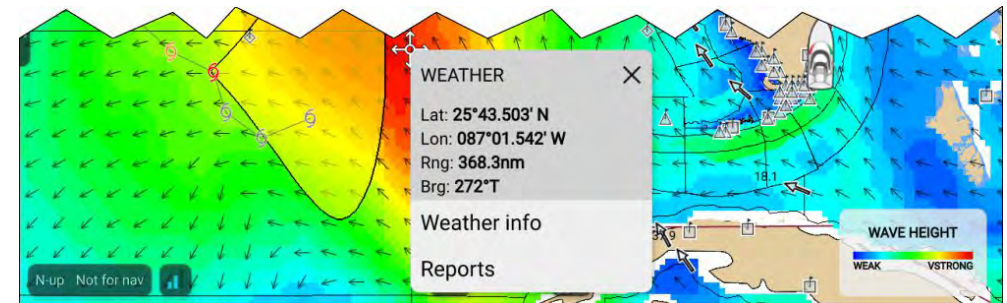

The context menu provides access to the following reports:

- *[Weather info]*— always available.
- *[Reports]*— always available.
- *[Watchbox data]*— available when selecting a watchbox area.
- *[Storm cast data]*— available when selecting a storm cast arrow.
- *[Storm data]*— available when selecting a storm track symbol.
- *[Forecast for...]*— available when selecting a city symbol.

17.2 Weather mode main menu

Weather mode includes menu items related to weather data. Active navigation and target tracking menus such as *[Targets]*, *[Go]* and *[New]* are not available.

The following options are available from the main menu:

- *[Find ship]*— The find ship icon will be available in the main menu and as an onscreen icon anytime that your vessel is not centred in the chart app.

- *[Mode]*— Chart app mode can be changed at anytime by selecting a mode. For details of available chart modes refer to: [p.196 — Chart modes](#)
- *[Weather layers]*— Allows you to select the weather layers that you want to display. For details refer to: [p.264 — Weather layers](#)
- *[Data display limits]*— Allows you to restrict the display data limits for the sea surface temperature layer.
- *[Reports]*— Displays text based weather reports for your vessel current location.
- *[Animate weather]*— Activates weather animation mode. For details refer to: [p.265 — Animated weather](#)
- *[Show legend]*— Displays an onscreen legend for currently enabled layers.
- *[Settings]*— Provides access the chart app settings menu.. For details refer to: [p.272 — Weather mode settings menus](#)

You can check when fishing data was last received / updated from the *[Subscription]* settings menu: *[Menu > Settings > Subscription]*.

17.3 Activating your SiriusXM receiver

Your MFD is compatible with the SR150 and SR200 SiriusXM receivers. Your receiver must be activated before you can use weather mode on your MFD.

The following information is required to activate your SiriusXM receiver:

- Electronic Serial Number (ESN) — The ESN is printed on the product label located on the underside of your SiriusXM receiver. You can also access the ESN from the *[Weather]* settings menu in the chart app: *([Menu > Settings > Subscription > Receiver ESN])*.
 - Current billing information (if you already have a valid subscription).
 - Desired subscription package.
1. Obtain your SiriusXM receiver’s ESN.
 2. Visit the Sirius Marine Weather website: <http://www.siriusxm.com/sxmma-rine>, and choose a subscription package.
 3. Follow the “Activate Now” link to activate your receiver online. Alternatively, call 1–855–796–9847.

Once your SiriusXM receiver is activated weather mode will be available in the chart app menu.

SR200 diagnostics mode

The SR200 diagnostic mode can be accessed from the audio settings menu from the master MFD on the network. The diagnostics mode should be referred to when liaising with Sirius product support.

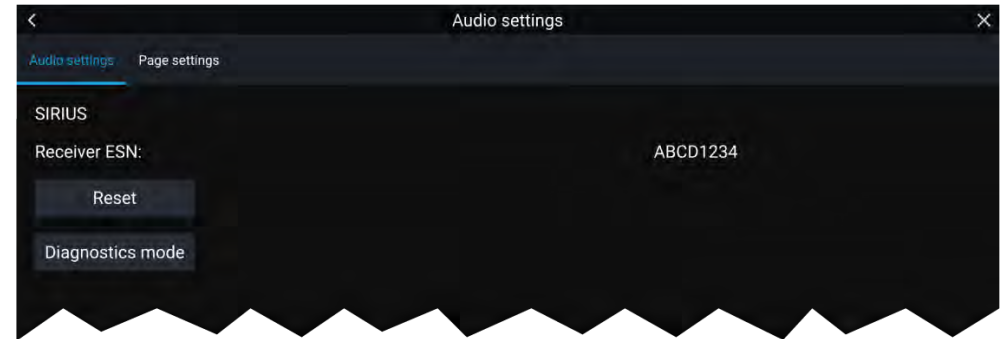

1. Reset — Performs a factory reset and power cycle of the SR200.
2. Diagnostics mode — Displays the SR200’s diagnostic information.

17.4 Weather layers

The weather layers can be enabled and disabled from the *[Weather layers]* menu: *[Menu > Weather layers]*.

The following weather layers are available in weather mode:

- *[Weather radar]*— For details refer to: [p.266 — Weather radar layer](#)
- *[Cities]* — For details refer to: [p.267 — Cities and Surface observation stations layers](#)
- *[Cloud top]*— For details refer to: [p.267 — Cloud top and Lightning layers](#)
- *[Lightning]*— For details refer to: [p.267 — Cloud top and Lightning layers](#)
- *[Sea surface temperature]* — For details refer to: [p.268 — Sea surface temperature and Surface pressure layers](#)
- *[Storm cast]* — For details refer to: [p.269 — Storm cast and Storm tracks layers](#)

- *[Storm tracks]* — For details refer to: [p.269 — Storm cast and Storm tracks layers](#)
- *[Surface pressure]* — For details refer to: [p.268 — Sea surface temperature and Surface pressure layers](#)
- *[Surface observation stations]* — For details refer to: [p.267 — Cities and Surface observation stations layers](#)
- *[Wind]* — For details refer to: [p.270 — Wind and Watchbox layers](#)
- *[Watchbox]* — For details refer to: [p.270 — Wind and Watchbox layers](#)
- *[Wave height]* — For details refer to: [p.271 — Wave direction, wave height and wave period layers](#)
- *[Wave period]* — For details refer to: [p.271 — Wave direction, wave height and wave period layers](#)
- *[Wave direction]* — For details refer to: [p.271 — Wave direction, wave height and wave period layers](#)

17.5 Animated weather

In weather mode you can play weather animations of historical weather radar data and forecasted wind, wave and surface pressure data.

Weather animations can be accessed in weather mode by selecting *[Animate weather]* from the menu.

When animate weather is selected the player controls and symbols representing weather layers are displayed.

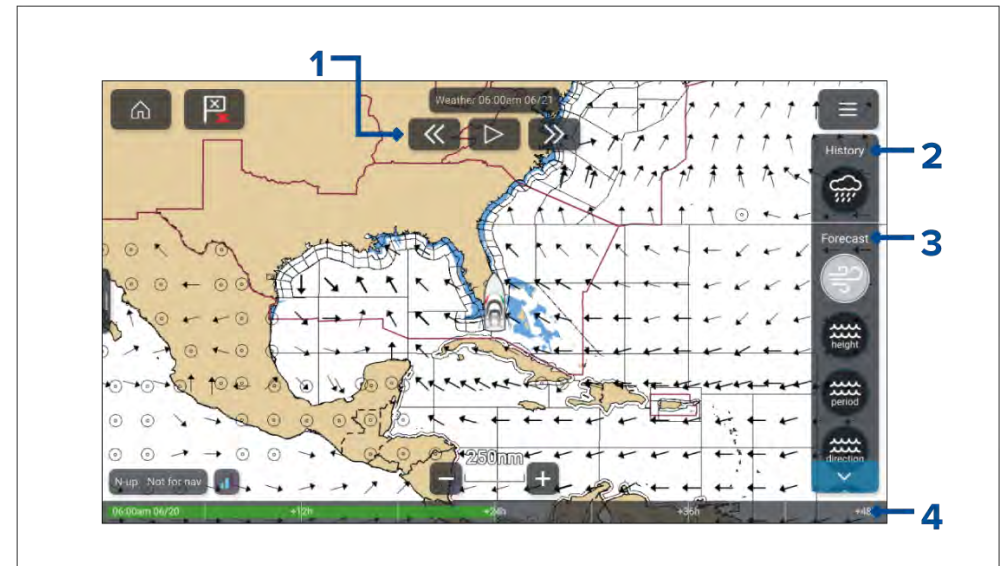

1. Player controls.
2. Historical data animation is available for the weather radar layer.
3. Forecasted data animation is available for wind, wave and surface pressure layers.
4. Animation progress bar.

Animated weather layers

Animations are available for the following layers: Selecting a symbol will display the animation for that layer.



1. *[Weather radar]*— Historical precipitation data for the previous 2 hours can be played.
2. *[Wind]*— Offshore wind forecast for up to 48 hours. High resolution coastal and inland wind forecast for up to 24 hours.
3. *[Wave height]*— Offshore wave height forecast for up to 48 hours. High resolution coastal wave height forecast for up to 24 hours. Great Lakes wave height forecast for up to 24 hours.
4. *[Wave period]*— Offshore wave period forecast for up to 48 hours. Great Lakes wave period forecast for up to 24 hours.
5. *[Wave direction]*— Offshore wave direction forecast for up to 48 hours. Great Lakes wave direction forecast for up to 24 hours.
6. *[Surface pressure]*— Surface pressure forecast for up to 48 hours.

To exit animations open the *[Menu]*.

17.6 Weather radar layer

With the weather radar layer enabled a color coded radar image is displayed. This image shows a complete view of any precipitation across North America, including the type and intensity. Rain, mixed and snow use different color scales to identify intensity. A legend is available that can be displayed

onscreen to aid identification of intensity. The images are displayed as pixels on screen and the resolution of this feature is 2 km per pixel. Coverage includes the Continental US, Canada, and portions of Mexico/Caribbean.

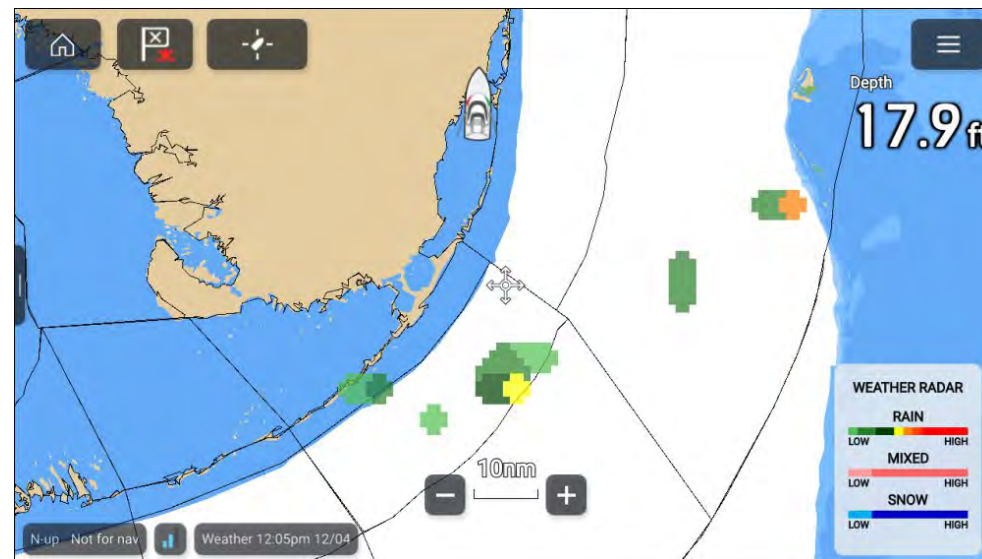

The legend can be enabled from the main menu: *[Menu > Show legend]*.

The weather radar layer can be enabled and disabled from the *[Weather layers]* menu: *[Menu > Weather layers > Weather radar]*.

When the weather radar layer is enabled the transparency of the layer can be adjusted using the *[Visibility]* setting: *[Menu > Weather layers > Weather radar > Visibility]*.

17.7 Cities and Surface observation stations layers

The Cities layer and Surface observation stations layer display symbols which represent the location of cities and surface observation stations respectively. The symbols used for surface observation stations also identify the type of station.

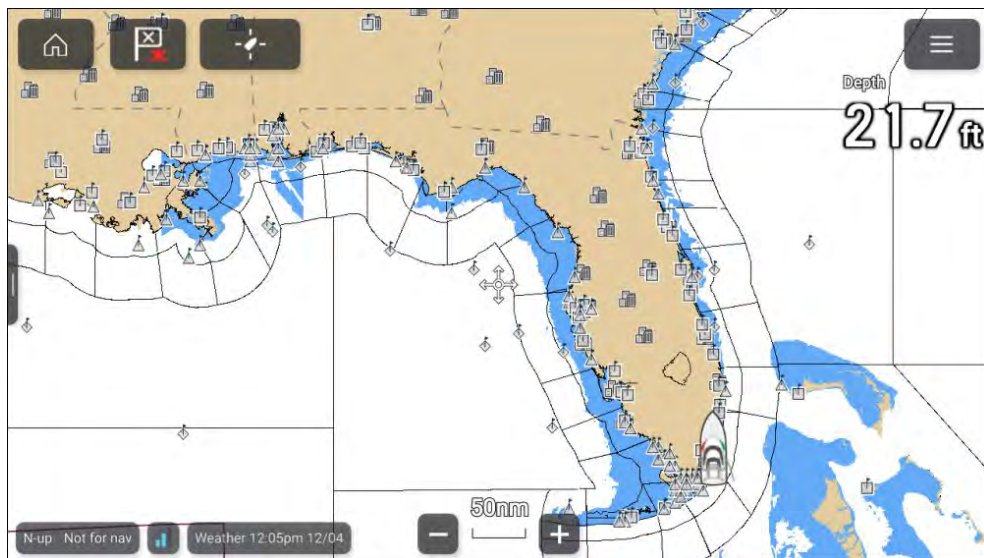

City forecasts are available from the context menu when a City is selected.

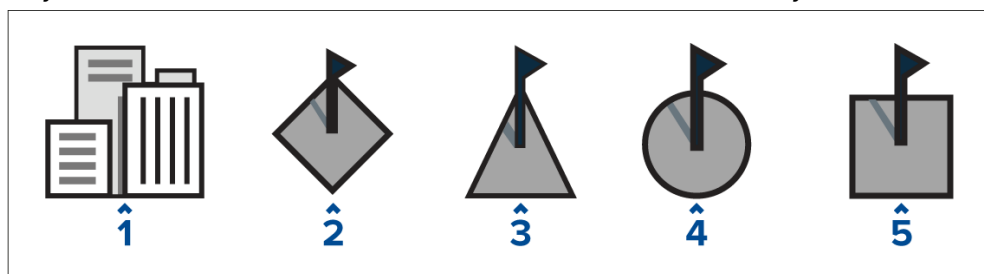

1. City
2. Buoy station
3. CMAN station (Coastal-marine automated network)
4. WSI station (Weather services international)
5. METAR station (METeoro logical Aerodrome Reports)

The cities layer can be enabled and disabled from the *[Weather layers]* menu: *[Menu > Weather layers > Cities]*.

The surface observation stations layer can be enabled and disabled from the *[Weather layers]* menu: *[Menu > Weather layers > Surface observation stations]*.

17.8 Cloud top and Lightning layers

The cloud top layer provides a satellite image of current cloud coverage and the lightning layer provides symbols to show the location of recent lightning strikes.



Cloud tops



Cloud tops use Gray shading to identify cloud top height. The shading changes at 5,000 feet increments, from Dark Gray to White. Clouds lower than 5,000 feet are not displayed. A legend is available that can be displayed onscreen to aid identification of cloud top heights.

The legend can be enabled from the main menu: *[Menu > Show legend]*.

The cloud tops layer can be enabled and disabled from the *[Weather layers]* menu: *[Menu > Weather layers > Cloud tops]*.

Lightning

The shade of the lightning symbols represent the time the lightning strike was detected.

		
0 to 5 minutes ago	5 to 10 minutes ago	10 to 15 minutes ago

The lightning layer can be enabled and disabled from the *[Weather layers]* menu: *[Menu > Weather layers > Lightning]*.

17.9 Sea surface temperature and Surface pressure layers

The Sea surface temperature layer uses color coding to identify water temperature. A legend is available that can be displayed onscreen to aid identification of sea surface temperature. The Surface pressure layer uses standard pressure patterns and Isobars to identify surface pressure.

The legend can be enabled from the main menu: *[Menu > Show legend]*.

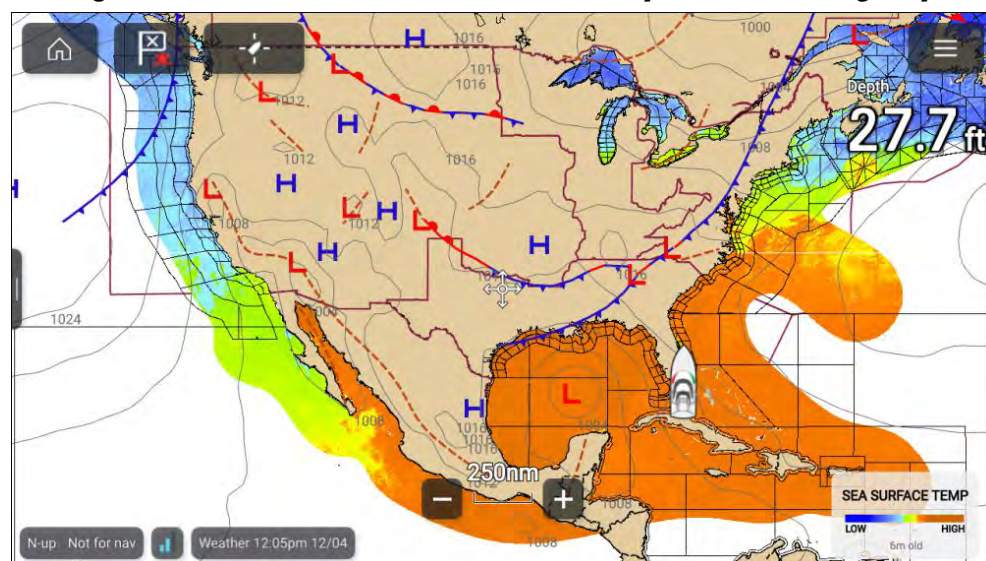





The sea surface temperature layer can be enabled and disabled from the *[Weather layers]* menu: *[Menu > Weather layers > Sea surface temperature]*.



When the sea surface temperature layer is enabled the transparency of the layer can be adjusted using the *[Visibility]* setting: *[Menu > Weather layers > Sea surface temperature > Visibility]*.

The Surface pressure layer can be enabled and disabled from the *[Weather layers]* menu: *[Menu > Weather layers > Surface pressure]*.

Surface pressure patterns

The Surface pressure layer uses standard meteorological patterns to represent surface pressure conditions.

Symbol	Description
	High / low pressure (Blue and Red)
	Warm front (Red)
	Cold front (Blue)
	Occluded front (Purple)
	Stationary front (Red-Blue)

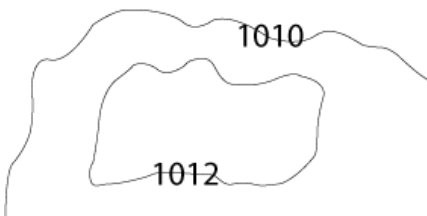
Symbol	Description
	Trough (Brown)
	Squall line (Red)
	Dry line (Red)
	Isobars (Gray)

17.10 Storm cast and Storm tracks layers

The storm cast layer displays arrows that identifies a storm's direction and speed. The storm tracks layer identifies a storm's historic, current and forecasted path. Associated wind fields are also shown for the storm's current location.

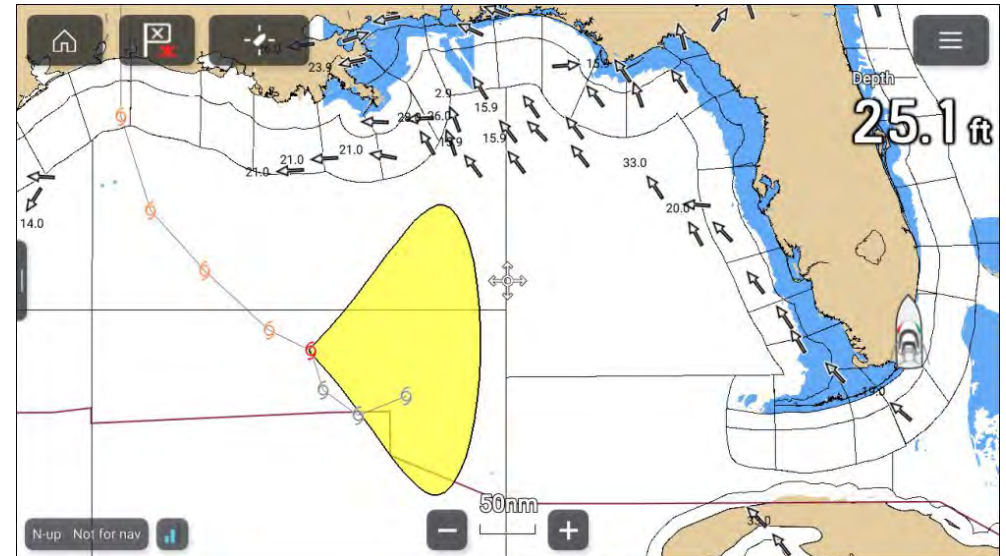

Storm track symbols

Storm track symbols identify the type and time period of the storm.

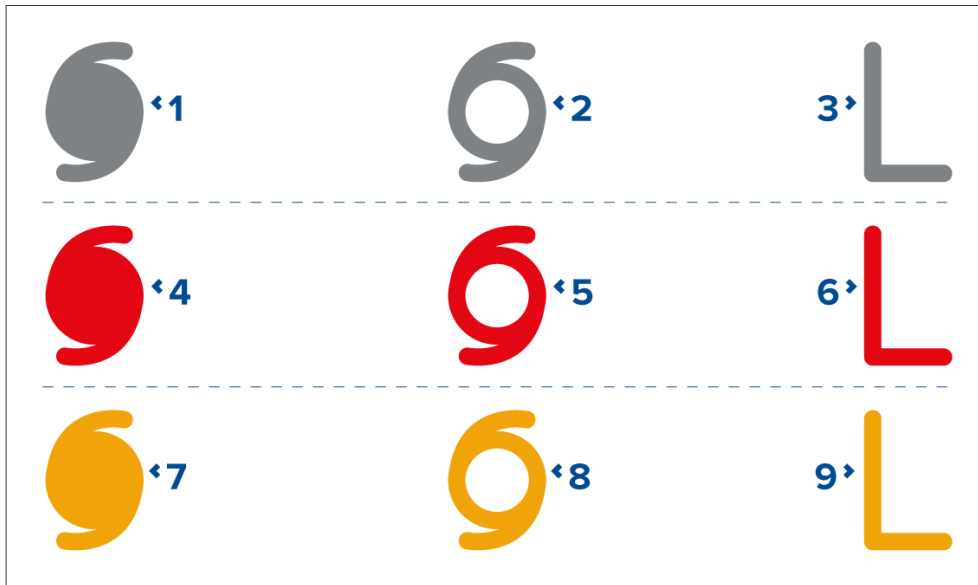

- **1, 2** and **3** represent historical data.
- **4, 5** and **6** represent current data.
- **7, 8** and **9** represent forecast data.
- **1, 4** and **7** represent a hurricane (category 1 to 5).
- **2, 5** and **8** represent a tropical storm.
- **3, 6** and **9** represent a tropical disturbance, tropical depression.

Storm data is available from the context menu when a symbol is selected.

Surface wind fields (wind radii) are shown using colored shape representing the wind field area and speed.

- **Pink** — wind speed = 64 knots or greater.
- **Orange** — wind speed = 50 knots or greater.
- **Yellow** — wind speed = 34 knots or greater.

The storm cast layer can be enabled and disabled from the *[Weather layers]* menu: *[Menu > Weather layers > Storm cast]*.

The storm tracks layer can be enabled and disabled from the *[Weather layers]* menu: *[Menu > Weather layers > Storm tracks]*.

17.11 Wind and Watchbox layers

The wind layer uses arrows or barbs to identify wind direction and speed. The watchbox layer uses red polygons to identify areas where severe weather is occurring or forecast within a specified range.

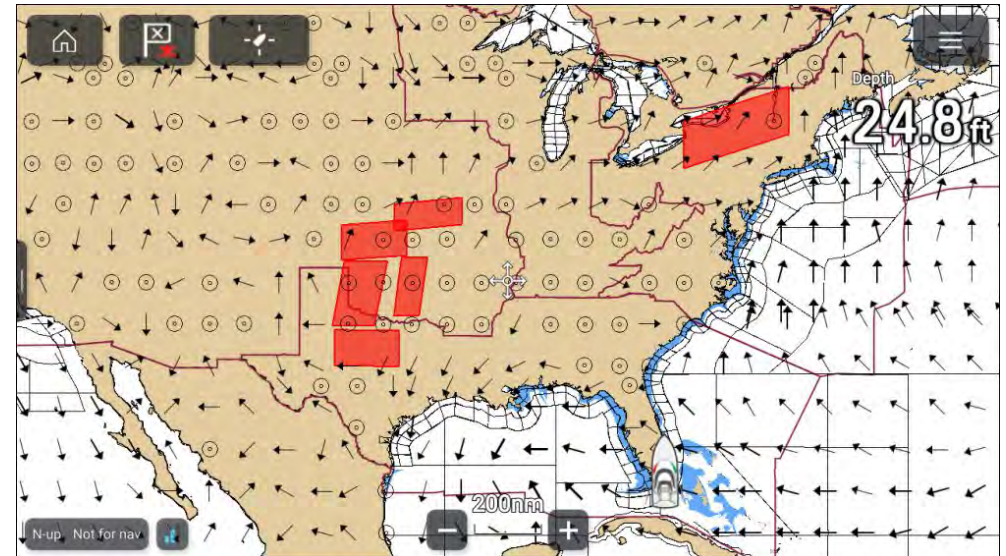

Wind arrows

The direction of the arrows indicates the wind direction and the size of the arrow indicates wind speed, the larger the arrow the greater the wind speed. Where conditions are calm a circular symbol is used.

Wind barbs

Wind barbs identify wind direction and speed.

Barbs provide a more accurate speed identification than arrows.

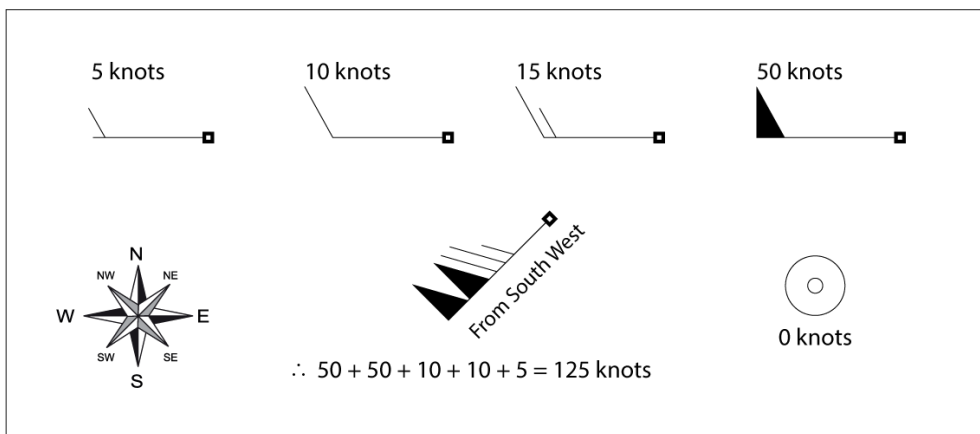

Adding the half barbs, full barbs and flags together provides wind speed. The direction the barbs point towards indicates where the wind is coming from.

- Half barbs = 5 knots
- Full barbs = 10 knots
- Flag = 50 knots

The wind layer can be enabled and disabled from the *[Weather layers]* menu: *[Menu > Weather layers > Wind]*.

You can switch between using *[Arrows]* or *[Barbs]* for wind data from the *[Weather settings]* menu: *[Menu > Settings > Weather > Wind symbol]*.

Watchbox

The watchbox layer can be enabled and disabled from the *[Weather layers]* menu: *[Menu > Weather layers > Watchbox]*.

When the watchbox layer is enabled you can select a watchbox area onscreen and view the details by selecting *[Watchbox data]* from the context menu.

Watchbox alerts

Watchbox alerts are alert notifications that are displayed onscreen if a tornado or thunderstorm alert is received. Watchbox alerts can be enabled and disabled from the *[Weather]* settings menu *[Menu > Settings > Weather > Watchbox alerts]*.

You can specify the range from your vessel that will trigger an alerts using the Watchbox range setting: *[Menu > Settings > Weather > Watchbox range]*.

17.12 Wave direction, wave height and wave period layers

The wave direction layer uses arrows to identify the direction waves are travelling. The wave height layer uses color coding to identify the height of waves, the wave period layer also uses color coding to identify the gap between waves. A legend is available that can be displayed onscreen to aid identification of wave height and wave period.

The legend can be enabled from the main menu: *[Menu > Show legend]*.

Wave direction and wave height

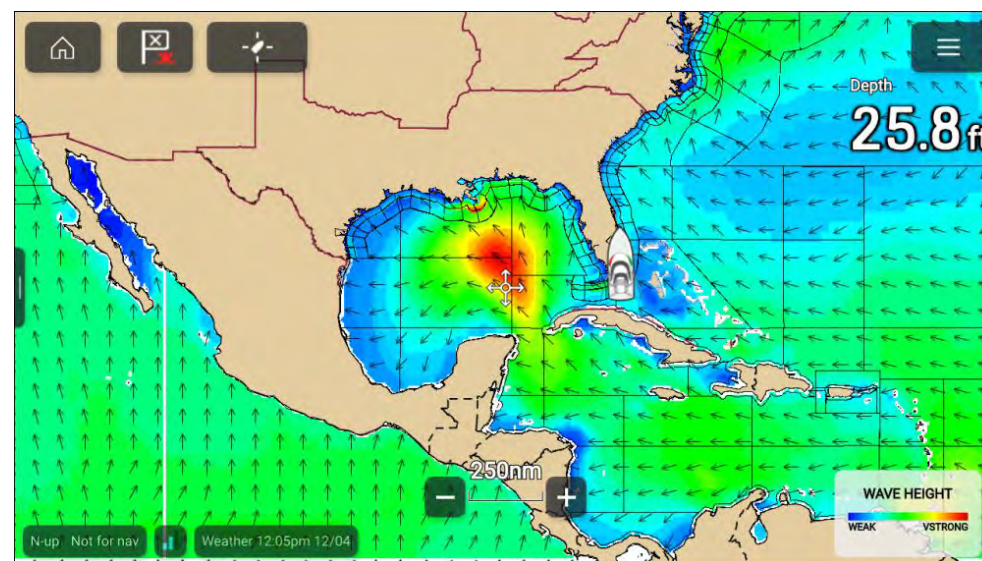

The wave direction layer can be enabled and disabled from the *[Weather layers]* menu: *[Menu > Weather layers > Wave direction]*.

The wave height layer can be enabled and disabled from the *[Weather layers]* menu: *[Menu > Weather layers > Wave height]*.

Wave period

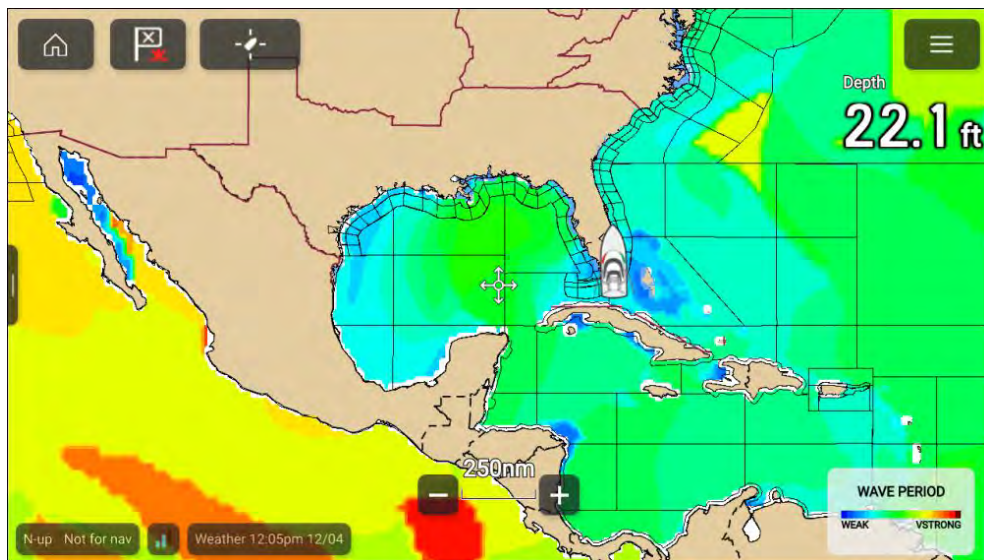

The wave period layer can be enabled and disabled from the *[Weather layers]* menu: *[Menu > Weather layers > Wave period]*.

17.13 Weather mode settings menus

The following settings menus are available in weather mode:

- *[Cartography]*— For details refer to: [p.243 – Cartography settings menu](#)
- *[Weather]*— For details refer to: [p.272 – Weather settings menu](#)
- *[Subscription]*— For details refer to: [p.272 – Weather subscription](#)
- *[Advanced]*— For details refer to: [p.250 – Advanced settings menu](#)
- *[Page settings]*— For details refer to: [p.251 – Page settings menu](#)

17.14 Weather settings menu

The weather setting menu contains settings related to SiriusXM weather receiver data.

Menu item and description	Description
<i>[Wind symbol]</i> Determines whether <i>Arrows</i> or <i>Barbs</i> are used for Wind direction graphics in Weather mode.	<ul style="list-style-type: none"> • <i>Arrows</i> • <i>Barbs</i>
<i>[Marine zone boundaries]</i> Determines whether marine boundaries are shown in Weather mode.	<ul style="list-style-type: none"> • <i>On</i> • <i>Off</i>
<i>[Watchbox alerts]</i> Enables and disables Watchbox alerts.	<ul style="list-style-type: none"> • <i>On</i> • <i>Off</i>
<i>[Watchbox range]</i> Determines the range from your vessel that Watchbox alerts are displayed	<ul style="list-style-type: none"> • <i>10nm</i> • <i>50nm</i> • <i>150nm</i> • <i>300nm</i> • <i>500nm</i>

17.15 Weather subscription

You can check your Sirius subscription status and data receipt from the *[Subscription]* settings menu: *[Menu > Settings > Subscription]*.

Data Type	Updated	Received	Receiver ESN: Simulator
High Res Forecast Winds Direction (14)	06/20 12:00pm	01/21/2013 09:12	Signal strength: [Bar]
High Res Forecast Winds Magnitude (13)	06/20 12:00pm	01/21/2013 09:12	Weather: Subscribed
Lightning (34)	06/20 12:55pm	4 mins ago	
Low Res Forecast Winds Direction (12)	06/20 06:00am	01/21/2013 09:10	

The subscription settings menu will list the data types that have been received and provide the date and time it was received and last updated.

You can also check your subscription status, your receiver's ESN and your receiver's signal strength.

17.16 Glossary of weather terms

Term	Definition
Cold front	The boundary between two different air masses where cold air pushes warm air out of the way and brings colder weather.
Cyclone	A large area of low atmospheric pressure, characterized by inward spiralling winds. A “low” also called a “depression”. Also the name used for a hurricane in the Indian Ocean and Western Pacific.
Depression	An area of low pressure. Also called a cyclone.
Dry line	A region where there is a strong gradient in dew point temperatures. It is often found in a region where strong thunderstorms develop.
Forecast	A prediction which informs us what the weather is going to be like within a specific location.
Front	The boundary between two masses of air with different temperatures (i.e. a mass of cold air and a mass of warm air).
High	Also known as an 'anticyclone' — an area of high atmospheric pressure with a system of winds rotating outwards. This usually means dry weather. It is the opposite of a 'low'.
High Pressure	A mass of air that presses down strongly on the surface of the Earth because it is being cooled and is therefore more dense.
Hurricane	<p>A violent, spiralling storm that forms over the Atlantic Ocean, with winds over 120 kph. Such storms usually have a lifespan of several days. Also known as a typhoon or tropical cyclone. There are 5 levels of hurricane:</p> <ul style="list-style-type: none"> • Category 1 — Winds 74–95 mph (64–82 kt or 119–153 km/hr). Storm surge generally 4–5 ft above normal. No real damage to building structures. Damage primarily to unanchored mobile homes, shrubbery, and trees. Some damage to poorly constructed signs. Also, some coastal road flooding and minor pier damage. • Category 2 — Winds 96–110 mph (83–95 kt or 154–177 km/hr). Storm surge generally 6–8 feet above normal. Some roofing material, door, and window damage of buildings. Considerable damage to shrubbery and trees with some trees blown down. Considerable damage to mobile homes, poorly constructed signs, and piers. Coastal and low lying escape routes flood 2–4 hours before arrival of the hurricane centre Small craft in unprotected anchorages break moorings. • Category 3 — Winds 111–130 mph (96–113 kt or 178–209 km/hr). Storm surge generally 9–12 ft above normal. Some structural damage to small residences and utility buildings with a minor amount of curtain wall failures. Damage to shrubbery and trees with foliage blown off trees and large trees blown down. Mobile homes and poorly constructed signs are destroyed. Low lying escape routes are cut by rising water 3–5 hours before arrival of the centre of the hurricane. Flooding near the coast destroys smaller structures with larger structures damaged by battering from floating debris. Terrain continuously lower than 5 ft above mean sea level may be flooded inland 8 miles (13 km) or more. Evacuation of low lying residences with several blocks of the shoreline may be required. • Category 4 — Winds 131–155 mph (114–135 kt or 210–249 km/hr). Storm surge generally 13–18 ft above normal. More extensive curtain wall failures with some complete roof structure failures on small residences. Shrubs, trees, and all signs are blown down. Complete destruction of mobile homes. Extensive damage to doors and windows. Low lying escape routes may be cut by rising water 3–5 hours before arrival of the centre of the hurricane. Major damage to lower floors of structures near the shore. Terrain lower than 10 ft above sea level may be flooded requiring massive evacuation of residential areas as far inland as 6 miles (10 km).

Term	Definition
	<ul style="list-style-type: none"> • Category 5 — Winds greater than 155 mph (135 kt or 249 km/hr). Storm surge generally greater than 18 ft above normal. Complete roof failure on many residences and industrial buildings. Some complete building failures with small utility buildings blown over or away. All shrubs, trees, and signs blown down. Complete destruction of mobile homes. Severe and extensive window and door damage. Low lying escape routes are cut by rising water 3–5 hours before arrival of the centre of the hurricane. Major damage to lower floors of all structures located less than 15 ft above sea level and within 500 yards of the shoreline. Massive evacuation of residential areas on low ground within 5–10 miles (8–16 km) of the shoreline may be required.
Isobar	A line on a weather map linking areas with equal air pressure.
Lightning	Discharge of static electricity in the atmosphere, usually between the ground and a storm cloud.
Low	Also called a 'depression' this region of low pressure can mean wet weather.
Low Pressure	A mass of air that presses down only weakly on the surface of the Earth's surface as it is warmed and it therefore less dense.
Millibar	A unit used to measure atmospheric pressure.
Occluded Front	An area where warm air is pushed upwards as a cold front overtakes a warm front and pushes underneath it.
Precipitation	Moisture that is released from the atmosphere as rain, drizzle, hail, sleet or snow, as well as dew and fog.
Pressure Centre	A region of high or low pressure.
Squall line	A non-frontal band, or line, of thunderstorms.
Super typhoon	A typhoon that reaches maximum sustained 1 minute surface winds of at least 65 m/s (130 kt, 150 mph). This is the equivalent of a strong category 4 or 5 hurricane in the Atlantic basin or a category 5 severe tropical cyclone in the Australian basin.
Tornado	A funnel shaped whirlwind which extends to the ground from storm clouds.
Tropical cyclone	A low pressure system that generally forms in the tropics. The cyclone is accompanied by thunderstorms and, in the Northern Hemisphere, a counterclockwise circulation of winds near the earth's surface.
Tropical depression	An organized system of clouds and thunderstorms with a defined surface circulation and maximum sustained winds of 38 mph (33 kt) or less.
Tropical storm	An organized system of strong thunderstorms with a defined surface circulation and maximum sustained winds of 39–73 mph (34–63 kt).
Tropics	An area on the Earth's surface that lies between 30° north and 30° south of the equator.
Trough	An elongated area of relatively low atmospheric pressure, usually extending from the centre of a low pressure region.
Typhoon	The name for a tropical storm originating in the Pacific Ocean, usually the China Sea. They are basically the same as the hurricanes of the Atlantic Ocean and the cyclones of the Bay of Bengal.
Wave cyclone	A storm or low pressure centre that moves along a front.
Wave period	The period is the time gap between successive waves and the longer the period the slower the waves travel.

CHAPTER 18: CHART APP - TIDES MODE

CHAPTER CONTENTS

- 18.1 Tides mode — page 276
- 18.2 Tides mode main menu — page 276
- 18.3 Using animation controls — page 277
- 18.4 Setting a specific date for animations — page 277
- 18.5 Tide station information — page 277
- 18.6 LightHouse charts dynamic tide graphic — page 278
- 18.7 Navionics dynamic tide graphic — page 278
- 18.8 Current station information — page 278
- 18.9 LightHouse Charts dynamic current graphic — page 279
- 18.10 C-Map dynamic current graphic — page 279
- 18.11 Navionics dynamic current graphic — page 279
- 18.12 Displaying tide or current graphs — page 280
- 18.13 Tides mode settings menus — page 280

18.1 Tides mode

In Tides mode the Tides animation control is displayed onscreen and the Tide station and Current station symbols in the Chart app are replaced with dynamic graphics which identify Tide and Current conditions. You can use the animation controls to play Tide and Current predictions for a 24 hour period. The own vessel Tide vector is also enabled in Tides mode.

Note:

- The Tides mode is only available if you have cartography that provides the Tides and Current data. Refer to your cartography provider for more information.
- The Tides mode requires accurate date information, usually taken from the GNSS (GPS) position data available to your MFD. Alternatively, you can input a specific date manually.

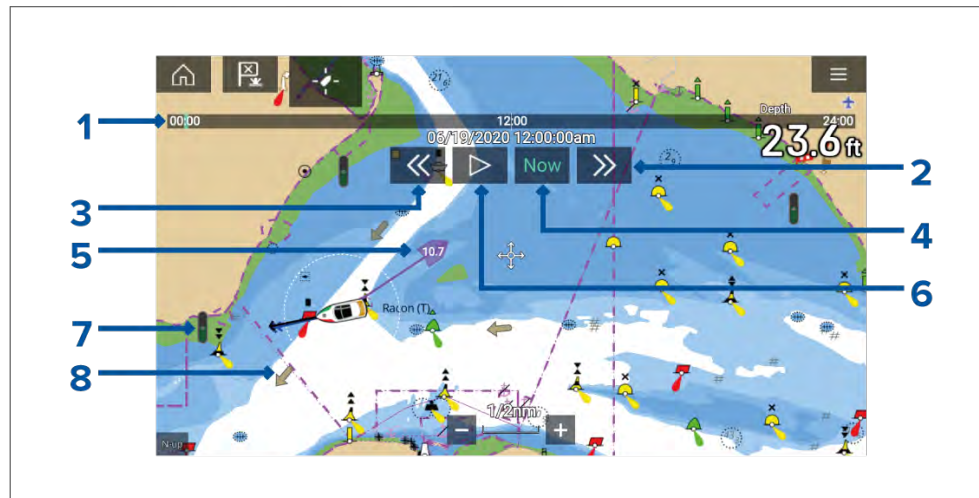

1. Animation progress bar — The progress bar is Blue for the current 24 hour period, or Green when playing animations from a different day.
2. Skip forwards — Skips forwards in user defined intervals, when the end of the progress bar is reached skipping forward will progress to the next day.
3. Skip backwards — Skips backwards in user defined intervals. When the beginning of the progress bar is reached, skipping backward will regress to the previous day.

4. Skip to the actual date / time — Position data is required from your GNSS (GPS) receiver to obtain current date and time.
5. Own vessel tide (Set and Drift) vector.
6. Play / Pause animation — When the animation is playing it will cycle through the current 24 hour period continuously.
7. Dynamic tide height graphic.
8. Dynamic current graphic.

Note:

The data provided in the Tide and Current graphs and graphics is for information purposes only and must NOT be relied upon as a substitute for prudent navigation. Only official government charts and notices to mariners contain all the information needed for safe navigation.

18.2 Tides mode main menu

The Tides mode menu contains items related to tides animation. Active navigation and target tracking menus such as *[Targets]*, *[Go]* and *[New]* are not available.

The following options are available from the main menu:

- *[Find ship]*— The find ship icon will be available in the main menu and as an onscreen icon anytime that your vessel is not centred in the chart app.
- *[Mode]*— Chart app mode can be changed at anytime by selecting a mode. For details of available chart modes refer to: [p.196 — Chart modes](#)
- *[Animate tides]*— For details refer to: [p.277 — Using animation controls](#)
- *[Select date]* — For details refer to: [p.277 — Setting a specific date for animations](#)
- *[Settings]*— Provides access the chart app settings menu. For details refer to: [p.280 — Tides mode settings menus](#)

18.3 Using animation controls

The animation controls can be selected using the Touchscreen, alternatively you can use the MFD's physical buttons or a RMK controller to control animations as described below:

With the Chart app set to *[Tides mode]*.

1. Select *[Animate tides]* from the menu.
2. Use the *[Left]* button on the Uni-controller to skip forwards in user defined intervals.
3. Use the *[Right]* button on the Uni-controller to skip backwards in user defined intervals.
4. Use the Uni-controller's *[OK]* button to Play or Pause the animation.

You can define the User skip time interval -from the Advanced menu: *[Menu > Settings > Advanced > Tide animation interval]*.

18.4 Setting a specific date for animations

You can select a specific date for the Tide and Current animation predictions.

1. Select *[Select date]* from the main menu.
2. Use the *[Up]* and *[Down]* arrows to change the date to the required day.
3. Select *[Save]*.

The animation will be set for the specified date.

18.5 Tide station information

When using compatible cartography, Tide station information is available at the location of Tide stations.

Tide station symbol

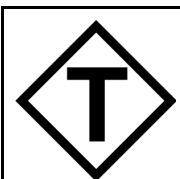

The location of Tide stations is marked on the Chart using a diamond-shaped symbol with a 'T' in the middle. The symbol color may vary.

Tide graph

Tide graphs can be accessed by selecting *[Tide station]* from the Tide station's context menu.

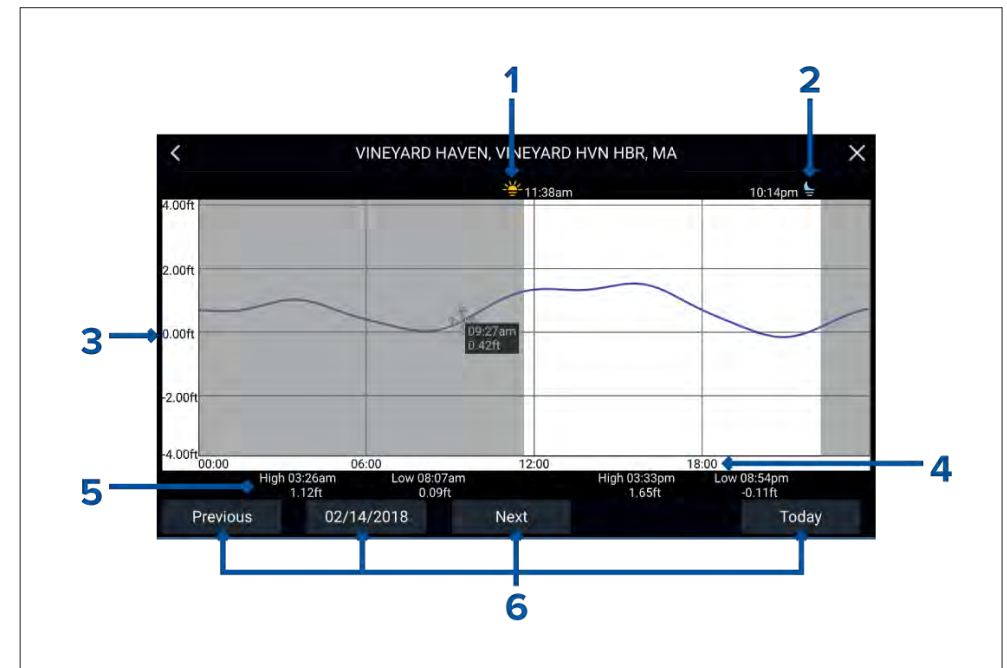

1. **Sunrise** — Indicates time of sunrise.
2. **Sunset** — Indicates time of sunset.
3. **Height** — Provides tide height in selected units.
4. **Time** — Indicates time of day.
5. **Low / High tide** — Indicates the time of low and high tides.
6. **Time and date options** — Use the buttons to view previous, next or today's tide predictions, or enter a date by selecting the date field.

18.6 LightHouse charts dynamic tide graphic

When the Tides layer is enabled or when the Chart app is in *[Tides mode]*, the standard Tide station symbol is replaced with a dynamic Tide height graphic:



1. High tide (Full Green indicator with equals symbol)
2. Decreasing tide (Red decreasing indicator with down arrow)
3. Low tide (Nearly empty Green indicator with equals symbol)
4. Increasing tide (Green indicator with up arrow)

18.7 Navionics dynamic tide graphic

When the Tides layer is enabled or when the Chart app is in *[Tides mode]*, the standard Tide station symbol is replaced with a dynamic Tide height graphic:

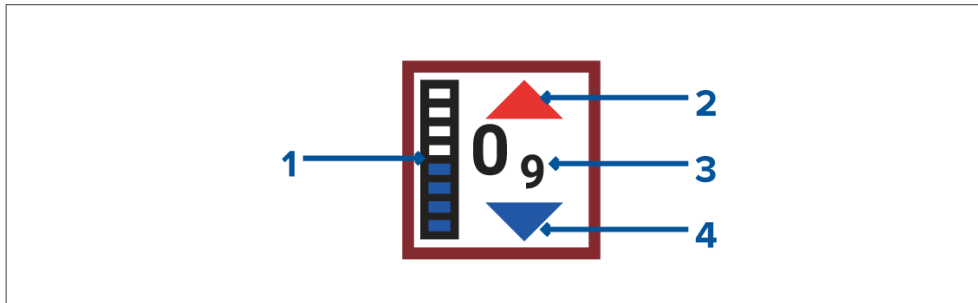

1. Tide bar — The tide bar plots the current tide height against the maximum predicted tide height for that day.
2. Red arrow indicates tide height is increasing.
3. Tide height — Tide height is displayed in user-selected depth units, with decimals displayed in subscript. Decimals are not shown for values of 10 or greater.
4. Blue arrow indicates tide height is decreasing.

18.8 Current station information

Depending on your cartography, Current station information may be available at the location of Current stations.

Current station symbol

	<p>The location of Current stations is marked on the Chart using a diamond-shaped symbol with a 'C' in the middle. The symbol color may vary.</p>
--	---

Current graph

Current graphs can be accessed by selecting *[Current station]* from the Current station's context menu.

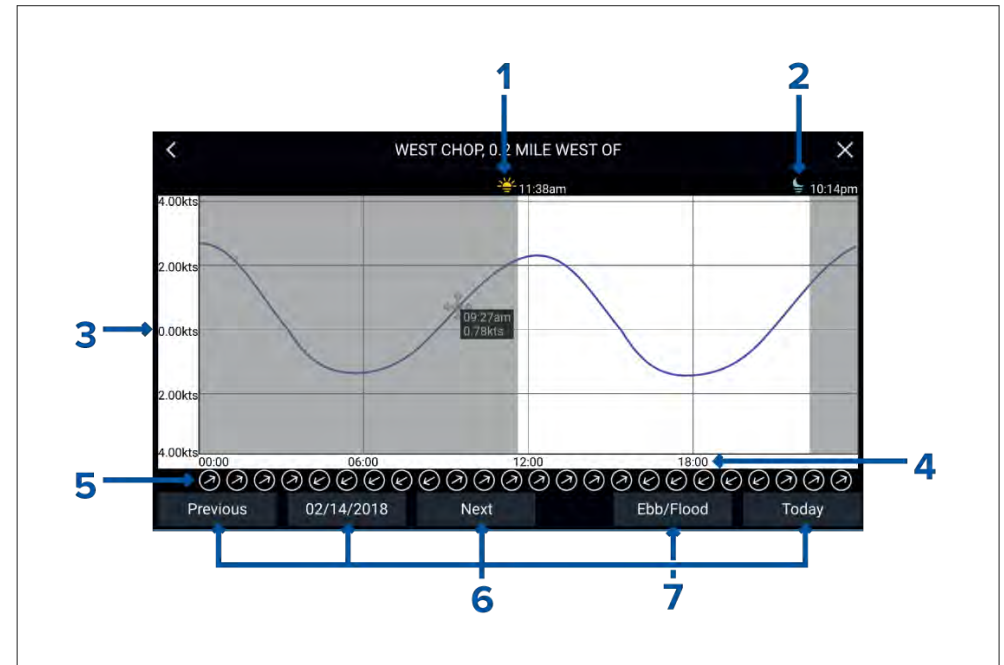

1. **Sunrise** — Indicates time of sunrise.
2. **Sunset** — Indicates time of sunset.
3. **Speed** — Provides current speed in selected units.
4. **Time** — Indicates time of day.

5. **Direction** — Indicates the direction of the current (relative to North).
6. **Time and date options** — Use the buttons to view previous, next or today's tide predictions, or enter a date by selecting the date field.
7. **Ebb / Flood** — Displays a list showing ebb, slack and flood tides.

18.9 LightHouse Charts dynamic current graphic

When the Tides layer is enabled or when the Chart app is in *[Tides mode]*, the standard Current station symbol is replaced with a dynamic Current graphic. Arrows are used to indicate the direction of current flow. The size and color of the arrow indicates the strength of the current:

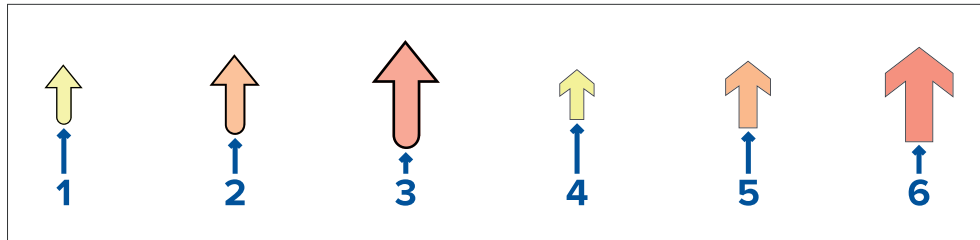

1. Yellow small arrow: 0 Knots to 1.0 Knots (Leisure chart style)
2. Orange medium arrow: 1.1 Knots to 2.0 Knots (Leisure chart style)
3. Red large arrow: Greater than 2.0 Knots (Leisure chart style)
4. Yellow small arrow: 0 Knots to 1.0 Knots (Government chart style)
5. Orange medium arrow: 1.1 Knots to 2.0 Knots (Government chart style)
6. Red large arrow: Greater than 2.0 Knots (Government chart style)

18.10 C-Map dynamic current graphic

When the Tides layer is enabled or when the Chart app is in *[Tides mode]*, the standard Current station symbol is replaced with a dynamic Current graphic. Arrows are used to indicate the direction of current flow. The size and color of the arrow indicates the strength of the current:

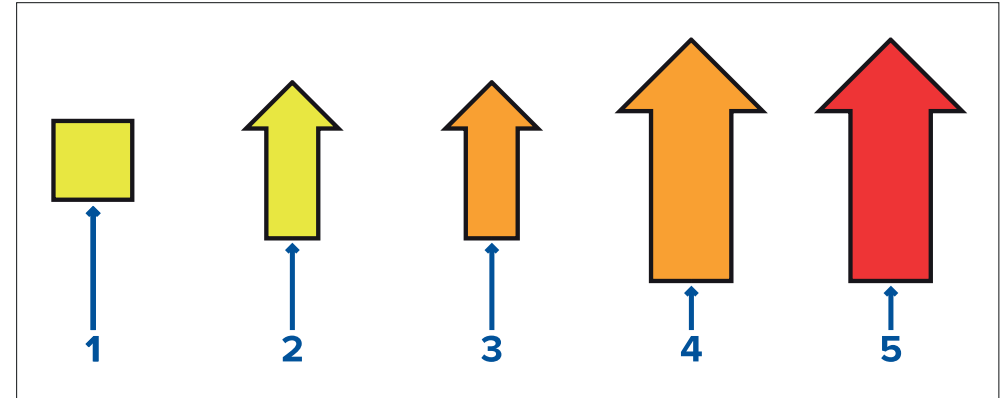

1. Yellow square: 0 Knots to 0.1 Knots
2. Yellow small arrow: 0.2 Knots to 1.0 Knots
3. Orange small arrow: 1.1 Knots to 2.0 Knots
4. Orange large arrow: 2.1 Knots to 3.0 Knots
5. Red large arrow: Greater than 3.0 Knots

18.11 Navionics dynamic current graphic

When the Tides layer is enabled or when the Chart app is in *[Tides mode]*, the standard Current station symbol is replaced with a dynamic Current graphic. Arrows are used to indicate the direction of current flow.

The length of the arrow indicates the speed of the current; the longer the arrow, the faster the speed. The border color of the arrow indicates increasing or decreasing speed.

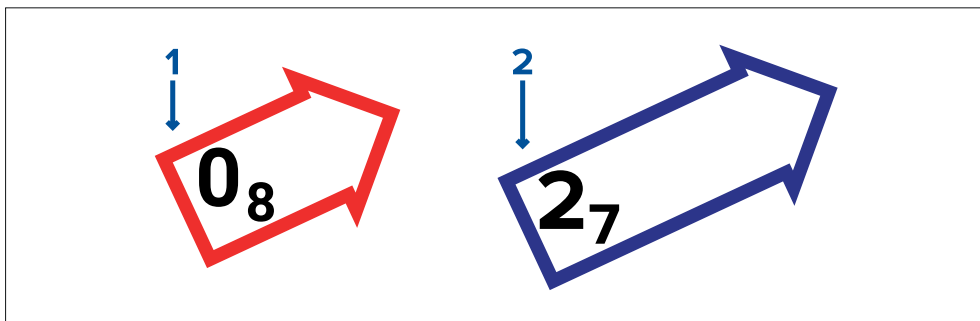

1. **Red** = increasing current speed.
2. **Blue** = decreasing current speed.

Current speed is shown inside the arrow. Current speed is displayed in user-selected speed units, with decimals displayed in subscript. Decimals are not shown for values of 10 or greater.

If tidal conditions are “slack”, the word “SLACK” appears in a box with a Blue border.

18.12 Displaying tide or current graphs

1. Select a tide or current station symbol or dynamic graphic.
2. Select *[more options]* from the context menu.
3. Select *[Tide station]* or *[Current station]*

Note:

You can also access tide and current graphs by selecting *[More info]* from the pop-over options when performing a *[Find nearest]* search for tides.

18.13 Tides mode settings menus

The following settings menus are available in tides mode:

- *[Cartography]*— For details refer to: [p.243 — Cartography settings menu](#)
- *[Advanced]*— For details refer to: [p.250 — Advanced settings menu](#)
- *[Page settings]*— For details refer to: [p.251 — Page settings menu](#)

CHAPTER 19: CHART APP - ANCHOR MODE

CHAPTER CONTENTS

- [19.1 Anchor mode — page 282](#)
- [19.2 Anchor mode main menu — page 283](#)
- [19.3 Setting up the anchor drag alarm — page 283](#)
- [19.4 Anchor mode settings menus — page 284](#)

19.1 Anchor mode

Anchor mode should be used when your vessel is at anchor. Anchor mode uses your vessel's GNSS (GPS) position to record your location when your anchor hits the bottom. Anchor mode will calculate if your vessel has dragged its anchor from its original location, based on specified values and then trigger the Anchor drag alarm. To activate the anchor drag alarm the Anchoring wizard must be completed.

Note:

[Anchor mode] does not take into account effects that tide may have on chain length or depth values.

Before Anchor mode can be used the system requires the following details:

- GNSS (GPS) position — via a connected receiver.
- Depth — via a connected transducer.
- Length of your vessel (bow to stern)— value specified in [Boat length] field.
- GNSS (GPS) receiver distance from vessel's bow — value specified in [Bow to GPS] field.

[Boat length] and [Bow to GPS] can be set in the [Boat details] settings tab: [Homescreen > Settings > Boat details]. If the values have not been set then you will be prompted to enter them when activating [Anchor mode] for the first time.

Note:

If depth data and position data are not available you will not be able to start the anchoring wizard.

Anchor mode uses the following data, measurements and calculations:

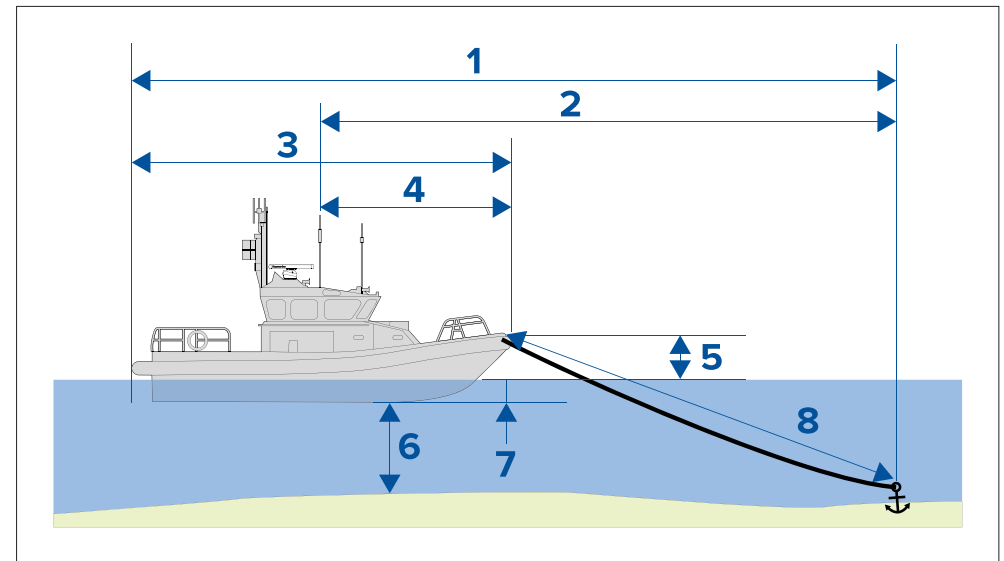

1. **Maximum swing radius** — calculation determined using Boat length, Bow to GPS distance, Chain length and Depth.
2. **Drag limit** — calculation determined using Maximum swing radius, Boat length and Bow to GPS distance.
3. **Boat length** — user defined measurement.
4. **Bow to GPS** — user defined measurement.
5. **Waterline to deck** — 1 meter is added to the calculation to allow for the distance from the waterline to the deck.
6. **Depth** — data received from depth transducer.
7. **Depth offset** — the specified depth offset is added to the calculation. The depth offset is based on your transducer settings (Zero if [Below transducer] is selected, positive value if [Below waterline] is selected and negative value if [Below keel] is selected.) Refer to: [p.313 — Depth offset](#)
8. **Chain length** — default calculation based on 4 times depth. Chain length can be altered manually to specify actual chain length.

The anchor drag alarm is triggered if your GNSS (GPS) receiver passes the distance from the original anchor position by the specified drag limit distance.

When anchor mode is active a track of your vessels movements will be recorded and representative graphics will be displayed onscreen in the chart app.

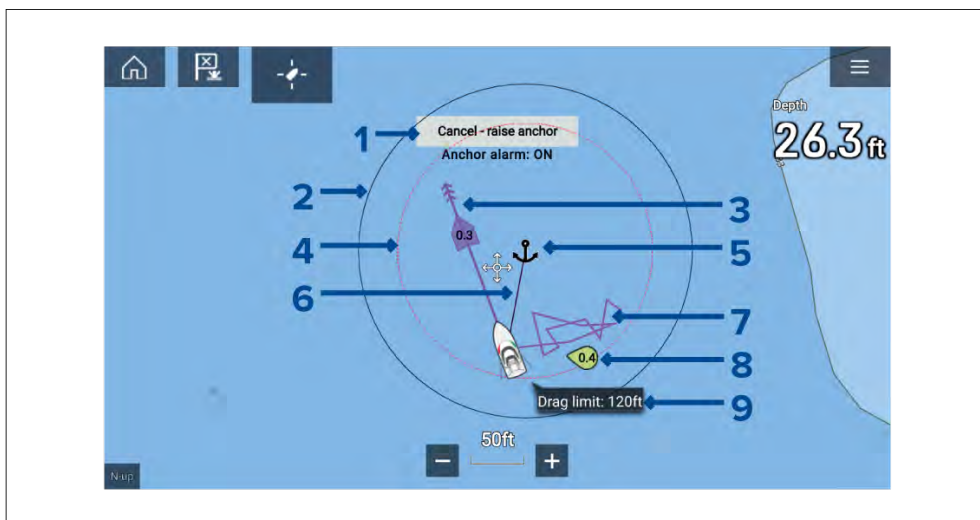

1. *[Cancel — raise anchor]*— selecting this button will cancel the anchor alarm. The status of the alarm is shown below the button.
2. **Max swing radius circle** — a circle with a solid black outline is placed around the anchor icon which represent the maximum swing radius.
3. **Tide vector** — Tide set and drift vector graphic.
4. **Drag limit circle** — a circle with a dashed red outline is placed around the anchor icon which represents the drag limit. The Anchor drag alarm is triggered when your vessel's GNSS (GPS) receivers passes this line.
5. **Anchor position** — an anchor icon is placed at the GPS position your vessel was located when Drop anchor was selected in the Anchoring wizard.
6. **Anchor chain** — a line is drawn between the anchor icon and the vessel icon to represent the anchor chain.
7. **Track line** — whilst the anchor alarm is active a track line will be recorded to show where your vessel has been.

Note: If a track is already being recorded when anchor mode is activated the current track is stopped and saved, once anchor mode is deactivated a new track will start recording automatically.

8. **Wind vector** — Wind speed and direction vector graphic

9. **Drag limit value** — Drag limit distance from anchor.

19.2 Anchor mode main menu

Anchor mode includes menu items related to the anchoring feature. Active navigation and target tracking menus such as *[Targets]*, *[Go]* and *[New]* are not available.

The following options are available from the main menu:

- *[Find ship]*— The find ship icon will be available in the main menu and as an onscreen icon anytime that your vessel is not centred in the chart app.
- *[Mode]*— Chart app mode can be changed at anytime by selecting a mode. For details of available chart modes refer to: [p.196 — Chart modes](#)
- *[Start anchoring]* — For details refer to: [p.283 — Setting up the anchor drag alarm](#)
- *[Raise anchor]*— Available when anchoring mode is active. Selecting will cancel anchoring.
- *[Chain length]*— Available when anchoring mode is active. Selecting allows you to adjust your chain length.
- *[Settings]*— Provides access the chart app settings menu. For details refer to: [p.284 — Anchor mode settings menus](#)

19.3 Setting up the anchor drag alarm

To set up the anchor drag alarm using the anchoring wizard follow the steps below.

1. Select a suitable location to anchor your vessel.
2. Select *[ANCHOR]* mode from the Chart app menu.
3. If prompted enter your *[Boat length]* and *[Bow to GPS]* distances and select *[OK]*.
4. Select the *[Start anchoring wizard]* button located on the center of the screen.

The anchoring wizard page 1 is displayed:

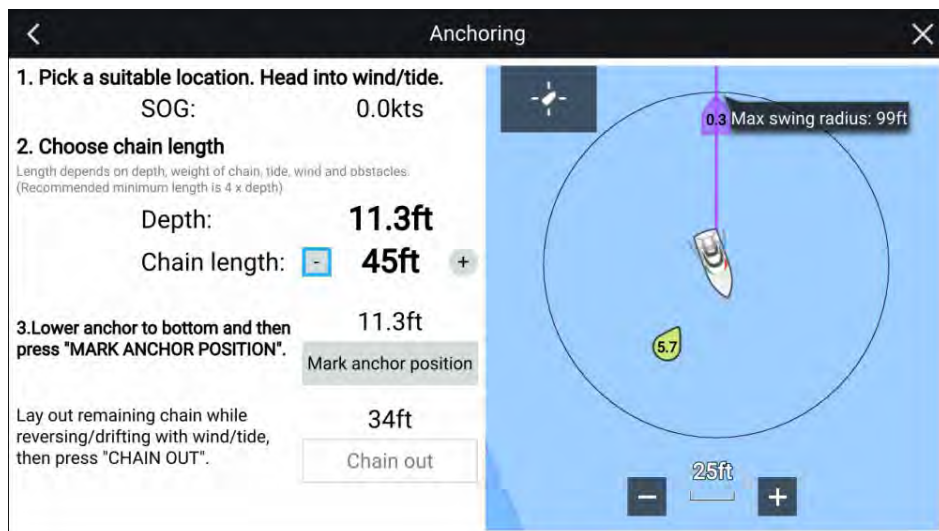

5. Based on the initial **Max swing radius** shown in the live view pane, ensure the location is suitable and that no obstacle could come into contact with your vessel as it drifts.
6. Head your vessel into the wind/tide.
7. If required, manually adjust the chain length using the *[Plus]* and *[Minus]* buttons.

By default the chain length is 4 times the water depth.

8. Lower your vessel's anchor.
9. Once the anchor hits the bottom select *[Mark anchor position]*.
10. Layout you remaining chain length while reversing / drifting with the wind/tide.
11. Select *[Chain out]*.

The anchoring wizard page 2 is displayed:

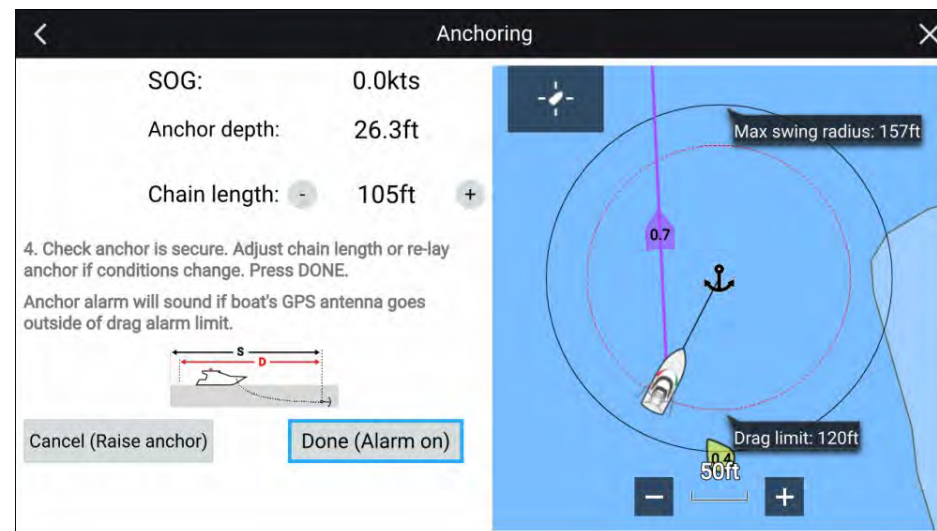

12. Check that the anchor is secure. If conditions have changed adjust the chain length or re-lay the anchor as appropriate.
13. Select *[Done (Alarm on)]*.
14. The Anchor drag alarm will be triggered if the vessel's antenna drifts outside of the specified Drag limit.

Once the Anchor drag alarm is active it can be cancelled at anytime by selecting *[Cancel – raise anchor]* from the Chart app screen or Raise anchor from the Alarms manager: *[Homescreen > Alarms > Settings > Anchor Drag > Raise anchor]*.

19.4 Anchor mode settings menus

The following settings menus are available in anchor mode:

- *[Cartography]*— For details refer to: [p.243 – Cartography settings menu](#)
- *[Layers]*— For details refer to: [p.244 – Layers settings menu](#)
- *[Depth]*— For details refer to: [p.247 – Depth settings menu](#)
- *[View & Motion]* — For details refer to: [p.249 – View & motion settings menu](#)
- *[Advanced]*— For details refer to: [p.250 – Advanced settings menu](#)
- *[Page settings]*— For details refer to: [p.251 – Page settings menu](#)

CHAPTER 20: SAILING FEATURES

CHAPTER CONTENTS

- 20.1 Chart app - Racing mode — page 286
- 20.2 Laylines — page 286
- 20.3 Wind shift bar — page 293
- 20.4 Sail plan recommendations — page 294
- 20.5 Sailing data page — page 296
- 20.6 Autopilot wind vane mode — page 296
- 20.7 Race start line (SmartStart™) and Race timer — page 299

20.1 Chart app - Racing mode

Racing mode

Racing mode enables sailing and race sailing related features such as the race timer and race start line.

Racing mode is available in the Chart app when *[Sailing]* has been selected as the activity during the initial MFD startup wizard.

Racing mode switches the Chart app to use the *Auto range [Cart motion]* mode option so that the Chart app maintains the largest chart scale that can display both the vessel icon and if applicable, the destination/target waypoint.

Racing mode main menu

In racing mode the main menu includes both common options and some sailing specific options.

The following options are available from the main menu:

- *[Find ship]*— The Find ship icon will be available in the main menu and as an onscreen icon anytime that your vessel is not centered in the chart app.
- *[Mode]*— Chart app mode can be changed at any time by selecting a mode. For details of available chart modes refer to: [p.196 — Chart modes](#)
- *[Go]*— Provides options to start active navigation.
- *[New]*— Provides options to create new waypoints, routes, tracks and search patterns.
- *[Race timer]* — For details refer to: [p.299 — Race Start Line \(SmartStart\) and Race Timer](#)
- *[Race start line]* — For details refer to: [p.299 — Race Start Line \(SmartStart\) and Race Timer](#)
- *[Waypoints, routes, track]*— Opens the *[My data]* menu to allow access to waypoints, routes and tracks lists. For details refer to: [p.104 — My data](#)
- *[Targets]* — Provides access to target tracking options. For details refer to: [p.223 — Target tracking](#)
- *[Settings]*— Provides access to the chart app settings menu. For details refer to: [p.286 — Racing mode settings menus](#)

Racing mode settings menus

The following settings menus are available in racing mode:

- *[Cartography]*— For details refer to: [p.243 — Cartography settings menu](#)
- *[Layers]*— For details refer to: [p.244 — Layers settings menu](#)
- *[Depth]*— For details refer to: [p.247 — Depth settings menu](#)
- *[View & Motion]* — For details refer to: [p.249 — View & motion settings menu](#)
- *[Laylines]*— For details refer to: [p.286 — Laylines](#)
- *[Advanced]*— For details refer to: [p.250 — Advanced settings menu](#)
- *[Page settings]*— For details refer to: [p.251 — Page settings menu](#)

20.2 Laylines

In sailing; Laylines are COG vector lines showing the course the boat will take when sailing at the optimum angle to the wind, on either tack. The laylines will show whether the boat will reach the intended destination on the current tack, or if another tack is required to meet the destination. Sailing to the target wind angle maximizes your Velocity Made Good (VMG) resulting in your boat traveling along the layline.

Laylines show the course to a destination point based on True Wind Direction (TWD) and the selected *[Sail performance]* option:

- *[Mirrored TWA]* (True Wind Angle) — This setting assume the boat is sailing to the optimum wind angle. The current boat heading is used as the active layline (adjusted for tides if the options has been enabled and with estimated leeway if not) and then mirrors the current TWA to show the opposite tack layline.
- *[Fixed Angles]*— The laylines use fixed upwind and downwind angles. For details refer to: [p.288 — Fixed angles laylines](#)
- *[Polar]*— The laylines use a polar table which reflects the performance of your particular vessel. For details refer to: [p.289 — Polar laylines](#)

[Sail performance] settings can be configured from the Homescreen settings menu *[Homescreen > Settings > Boat details]*.

The chart app's Laylines settings menu provides further options (*[Chart app > Settings > Laylines]*) which allow laylines to account for tides and leeway and to display wind shift graphics.

Example upwind laylines

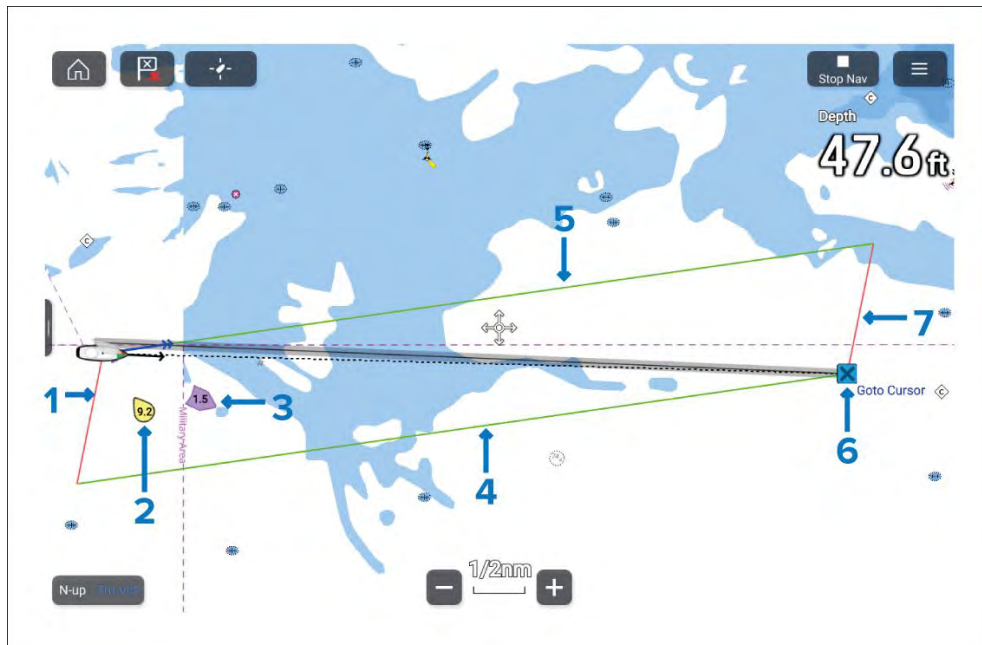

1. Port vessel layline.
2. TWD & TWS.
3. Tide direction and speed
4. Starboard destination layline.
5. Starboard vessel layline
6. Destination waypoint.
7. Port destination layline.

Note:

Laylines show the predicted COG (Course Over Ground) when steering to the optimum upwind or downwind angle. Due to tide and leeway; you will often have to point the boat at a different angle to the layline in order to travel along the line. Optimized steering guidance is available on the Sailing page of the Dashboard app.

Layline data requirements

The requirements for displaying laylines are as follows:

- The MFD's *[Activity]* must be set to *[Sailing]*. Boat activity is set during the MFD's initial startup wizard. If your MFD is not currently using the sailing activity then a factory reset is required to change activity to *[Sailing]*.
- The following sensor data must be available:
 - Wind data
 - Speed Through Water (STW)
 - GNSS data (COG, SOG, position)
 - Heading
- Display of laylines must also be enabled from either the Chart app *[Laylines]* settings menu: *[Menu > Settings > Laylines > Display laylines on this chart]* or from the *[Laylines]* vessel popover menu option.

Displaying and interpreting laylines

Laylines are displayed differently depending on navigation conditions.

Laylines are displayed when:

- A tack is required to meet an active *[Waypoint]* or *[Goto]*.
- The direct distance to the destination point is less than 150 nm from your vessel.

When the destination waypoint is **upwind** and the layline has not been reached, the laylines will be displayed as a parallelogram. Green lines represent starboard tack and red lines represent port tack.

Example upwind laylines

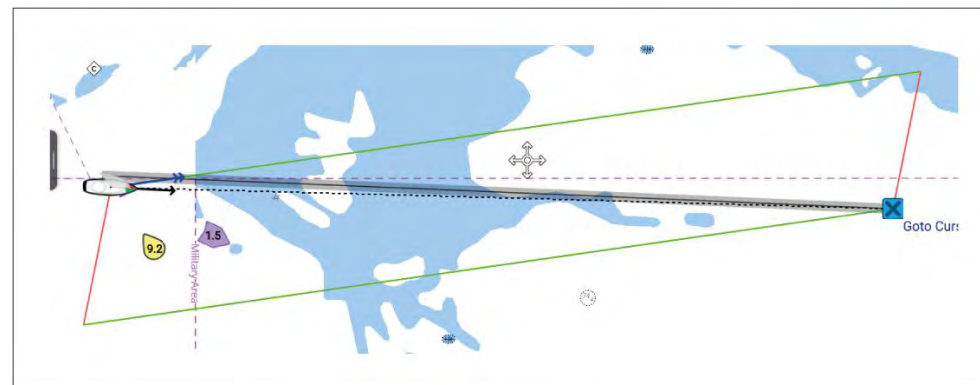

When the boat passes the layline required to make the destination waypoint only 1 layline is drawn from the boat and a perpendicular layline is drawn from the destination waypoint. Red lines are used for upwind port, green lines for upwind starboard.

This layline pair creates a corridor within which the boat can sail directly to the waypoint.

Example upwind port tack laylines

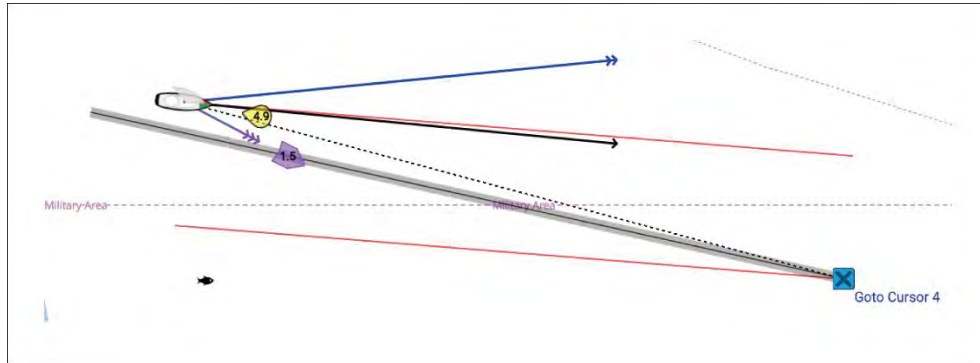

Example upwind starboard tack laylines

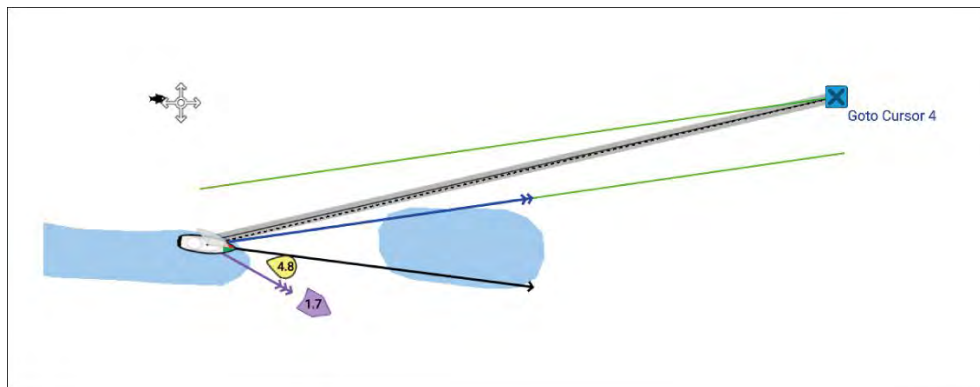

Example upwind boat laylines

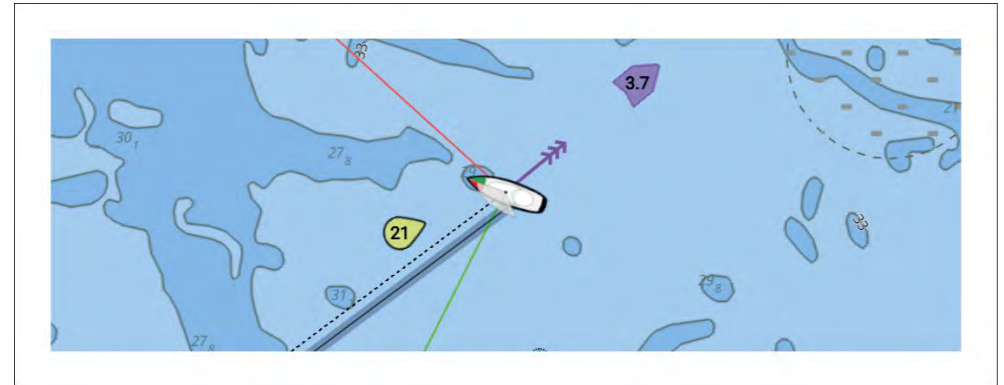

If there is no active navigation or the destination waypoint is more than 150 nm away, only boat laylines will be displayed.

When the destination waypoint is **downwind** the laylines will be displayed as an orange parallelogram, adjusted for gybing.

Fixed angles laylines

The following options are available for fixed angle laylines:

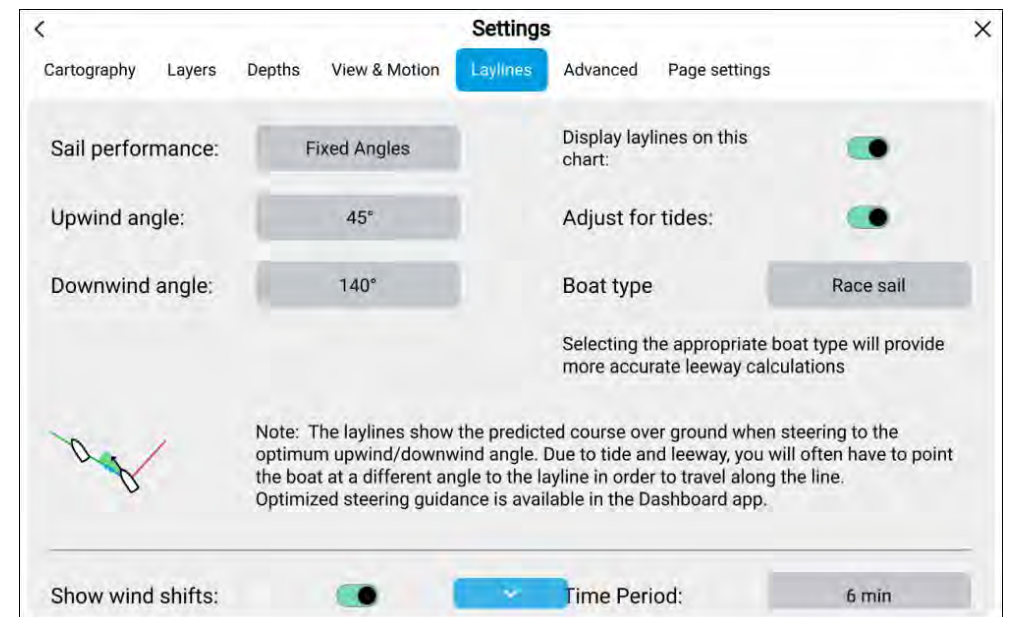

- *[Sail performance]*— Use this option to switch to *[Polar]* angles specific for your vessel or *[Mirrored TWA]*.
- *[Upwind angle]*— Specify the fixed upwind angle. The default upwind angle is 45° You can adjust the upwind angle to a value between 15° to 70°.
- *[Downwind angle]*— Specify the fixed Downwind angle. The default downwind angle is 140° You can adjust the downwind angle to a value between 125° to 175°.
- *[Boat type]*— Determines the boat icon used in the Chart app. Selecting one of the following boat types will also provide more accurate leeway calculations:
 - Sail cruiser (leeway 5° – 10°)
 - Race sail (leeway 3° – 5°)
 - Catamaran (leeway 10° – 20°)

Note:

- Leeway calculations are only used when Adjust for tides is disabled.
- If you select a boat type other than one with stated leeway angles then no leeway correction will be applied in the calculations.

- *[Display laylines on this chart]*— Enables and disables display of laylines in the current Chart app instance.
- *[Adjust for tides]*— When enabled layline calculations will take into account tidal flow and leeway.

Polar laylines

In sailing, the Velocity Made Good (VMG) principle demonstrates that travelling in a straight line is not always the quickest route, and polars enable you to optimize your vessel's performance to its best advantage, by improving the accuracy of LightHouse 4's dynamic laylines to display how far you need to sail on a current tack to reach a target waypoint after tacking and taking wind conditions into consideration.

Polars describe how fast a sailing vessel may travel at different wind speeds (TWS), and at different angles to the wind (TWA). Every type of sailing vessel has its own polar table (or VPP, Velocity Prediction Program), calculated from hull shape, weight, rigging, and sail setup. LightHouse 4 has Polar data for

over 500 popular sailing hulls preloaded. You can use the Polar options in the Laylines tab to select the boat model that best matches your own, in terms of Polar information.

For a list of preloaded polars, see: https://raymarine.custhelp.com/app/answers/detail/a_id/5712

You can also create your own table of polar data for your specific vessel, by downloading a template from the Raymarine website and populating the template with the key polar data for your vessel. This data is often provided by the boat manufacturer - refer to the manufacturer for more information.

You can download the Polar Table template here: <https://www.raymarine.com/en-gb/learning/online-guides/polar-performance-data>

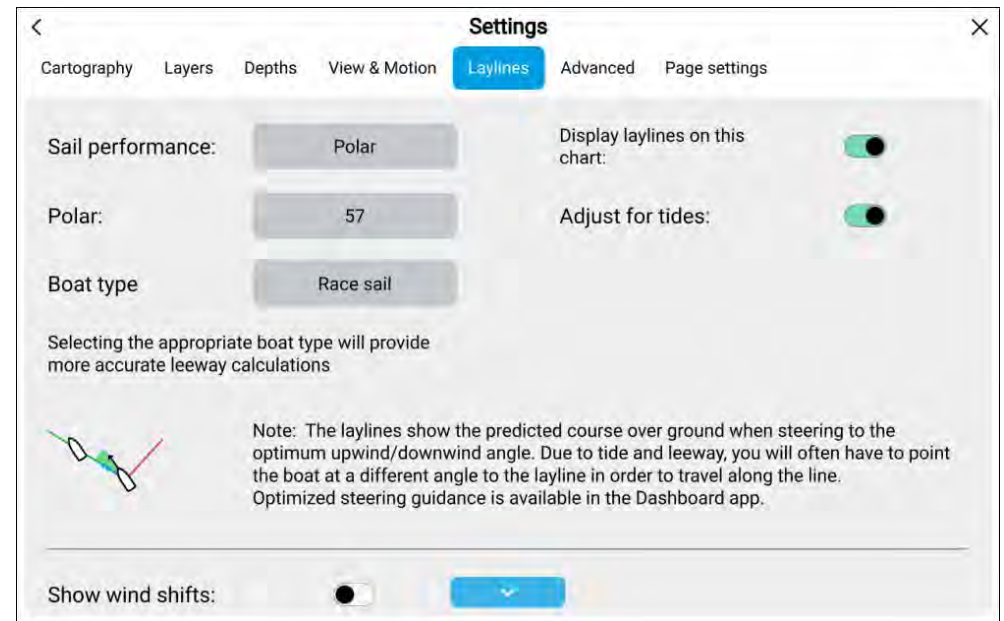

The following options are available for polar laylines:

- *[Sail performance]*— Use this option to switch to using specified angles *[Fixed angles]* or *[Mirrored TWA]*.
- *[Polar]*— Browse the list to find the boat model that most closely matches your own boat, or import your own polar table.
- *[Boat type]*— Determines the boat icon used in the Chart app. Selecting one of the following boat types will also provide more accurate leeway calculations:

- Sail cruiser (leeway 5° – 10°)
- Race sail (leeway 3° – 5°)
- Catamaran (leeway 10° – 20°)

Note:

- Leeway calculations are only used when Adjust for tides is disabled.
- If you select a boat type other than one with stated leeway angles then no leeway correction will be applied in the calculations.

- *[Display laylines on this chart]*— Enables and disables display of laylines in the current Chart app instance.
- *[Adjust for tides]*— When enabled layline calculations will take into account tidal flow and leeway.

Importing a Polar table

Polar Tables are collections of custom data related to the physical characteristics of a specific vessel which determine sailing performance. These Polar tables can be used to help you achieve maximum sailing performance for your specific vessel by describing how fast a sailing vessel may travel at different wind speeds (TWS), and at different angles to the wind (TWA). Every type of sailing vessel has its own polar table (or VPP, Velocity Prediction Program), calculated from hull shape, weight, rigging, and sail setup. LightHouse 4 uses this polar table information to calculate the fastest course, based on the current wind speed and direction. Polar data for over 500 popular sailing hulls is preloaded into LightHouse 4. If Polar data for your specific vessel is not preloaded, you can create your own Polar table in csv format and import it into LightHouse 4.

Typically, Polar data is provided by the boat manufacturer - refer to the manufacturer for more information.

Polar tables can be imported via the chart app *[Laylines]* settings menu and from the *[Boat details]* menu accessed from the Homescreen.

A Polar table template is available to download from the Raymarine website, which can be used as a starting point for your custom Polar table:
<https://www.raymarine.com/en-us/learning/online-guides/polar-performance-data>

1. Select the *[Sail performance]* button and choose *[Polar]* from the pop-over menu.

If this is the first time a polar has been selected or imported, the Select polar menu is displayed.

If a polar has already been selected or imported, select the *[Polar]* button instead to open the Select polar menu.

2. Select *[Import polar]*.
3. Browse to the csv file on your memory card.
4. Select the csv file.

You will be returned to the Select polar menu and the *[My Polars]* option should be available at the top of the list. The *[My polars]* option will be suffixed with the number of imported polars on the display.

5. Select *[My Polars]*.
6. Select the polar you just imported.
7. Select *[Activate polar]* from the pop-over menu.

The imported polar table will now be used.

Polar table csv file layout

Polar table csv files must be laid out as follows:

In the below example each value is placed in a separate cell.

Example polar table

	A	B	C	D	E	F	G	H	I	J	K	L	M
1	TWA - TWS	4	6	8	10	12	14	16	18	20	25	30	
2	45	0	0	0	0	0	0	0	0	0	0	0	
3	50	1	1.2	2.4	2.6	2.8	3	3.2	3.6	2.4	2.2	2	
4	55	1	1.2	2.4	2.6	2.8	3	3.2	3.6	2.4	2.2	2	
5	60	1	1.2	2.4	2.6	2.8	3	3.2	3.6	2.4	2.2	2	
6	70	1	1.2	2.4	2.6	2.8	3	3.2	3.6	2.4	2.2	2	
7	80	1	1.2	2.4	2.6	2.8	3	3.2	3.6	2.4	2.2	2	
8	90	1.5	2	2.5	3	3.2	3.6	3.8	4	4.5	5	6	
9	100	1.5	2	2.5	3	3.2	3.6	3.8	4	4.5	5	6	
10	110	1.5	2	2.5	3	3.2	3.6	3.8	4	4.5	5	6	
11	120	1.5	2	2.5	3	3.2	3.6	3.8	4	4.5	5	6	
12	130	1.5	2	2.5	3	3.2	3.6	3.8	4	4.5	5	6	
13	140	1.4	1.6	1.8	2	2.5	3	3.4	3.6	4	4.5	5	
14	150	1.4	1.6	1.8	2	2.5	3	3.4	3.6	4	4.5	5	
15	170	1.4	1.6	1.8	2	2.5	3	3.4	3.6	4	4.5	5	
16													

1. **TWA (True Wind Angle)** — Define the range of TWAs you want to enter Speed Through Water (STW) values for.

Note: As a minimum 3 rows must be included.

- TWS (True Wind Speed)** — Define the range of TWSs you want to enter speed values for.

Note: As a minimum 3 TWS values are required.

- STW (Speed Through Water) values** — Define the speed for each TWA/TWS.

Alternatively polar tables can be laid out with all values in 1 column as shown below:

Example alternate layout polar table

1	twa/tws;0;5;10;15;20;25;30;35;40;45;50;55;60
2	0;0.00;0.00;0.00;0.00;0.00;0.00;0.00;0.00;0.00;0.00;0.00;0.00
3	5;0.00;0.33;1.17;1.33;1.39;1.40;1.39;1.37;1.20;1.00;0.83;0.69;0.57
4	10;0.00;0.67;2.33;2.67;2.78;2.80;2.78;2.73;2.40;2.00;1.67;1.38;1.14
5	15;0.00;1.00;3.50;4.00;4.17;4.20;4.17;4.10;3.60;3.00;2.50;2.08;1.71
6	20;0.00;1.50;4.67;5.33;5.56;5.60;5.56;5.47;4.80;4.00;3.33;2.77;2.29
7	25;0.00;2.00;5.83;6.67;6.94;7.00;6.94;6.83;6.00;5.00;4.17;3.46;2.86
8	30;0.00;2.50;7.00;8.00;8.33;8.40;8.33;8.20;7.20;6.00;5.00;4.15;3.43
9	35;0.00;3.00;8.17;9.33;9.72;9.80;9.72;9.57;8.40;7.00;5.83;4.85;4.00
10	40;0.00;3.75;9.33;10.67;11.11;11.20;11.11;10.93;9.60;8.00;6.67;5.54;4.57
11	45;0.00;4.50;10.50;12.00;12.50;12.60;12.50;12.30;10.80;9.00;7.50;6.23;5.14

- TWS (True Wind Speed)** — All TWS values are entered in the top cell, separated using a semicolon.
- TWA (True Wind Angle)** — The TWA is entered as the first characters in each subsequent cell.
- STW (Speed Through Water)** — The speed for each TWS is entered for each TWA, separated using a semicolon.

A Polar table csv template is available to download from the following web page: <https://www.raymarine.com/en-us/learning/online-guides/polar-performance-data>

Adjusting a Polar table

Polar table that have been imported can be adjusted.

TWA/TWS	0.0kts	5.0kts	10.0kts	15.0kts	20.0kts	25.0kts	30.0kts	35.0kts
0.0°	0.00	0.00	0.00	0.00	0.00	0.00	0.00	0.00
5.0°	0.00	0.33	1.17	1.33	1.39	1.40	1.39	1.37
10.0°	0.00	0.67	2.33	2.67	2.78	2.80	2.78	2.73
15.0°	0.00	1.00	3.50	4.00	4.17	4.20	4.17	4.10
20.0°	0.00	1.50	4.67	5.33	5.56	5.60	5.56	5.47
25.0°	0.00	2.00	5.83	6.67	6.94	7.00	6.94	6.83
30.0°	0.00	2.50	7.00	8.00	8.33	8.40	8.33	8.20
35.0°	0.00	3.00	8.17	9.33	9.72	9.80	9.72	9.57
40.0°	0.00	3.75	9.33	10.67	11.11	11.20	11.11	10.93

Only the vessel speed values can be adjusted, the TWA and TWS ranges cannot be changed.

- Select the imported Polar table that you want to adjust from the *[My polars]* list.
- Select *[Adjust polar table]* from the pop-over menu.
- Select the value that you want to adjust.
- Use the *[Up]* and *[Down]* arrows on the numeric adjustment control to change the value.
- Select another location on the screen to close the numeric adjustment control and then select *[Save]*.

Imported polar table options

When an imported polar table is selected from the *[My polars]* list a pop-over menu is displayed which has a number of options.

The pop-over menu options are:

- [Activate polar]*— Selecting will activate the selected polar table.

- *[Rename]*— Selecting will open the onscreen keyboard where you can rename the polar table.
- *[Adjust polar table]*— Selecting will open the polar table where you can adjust vessel speed values.
- *[Duplicate]*— Selecting will create a copy of the selected polar table.
- *[Delete]*— Selecting will delete the selected polar table from the display.

Wind shift data

As True Wind Direction (TWD) is constantly changing, the position of the laylines changes over time. These changes are shown as lighter colored shaded triangles which represent the variation of TWD over a specified time period.

Variation — Low end of range

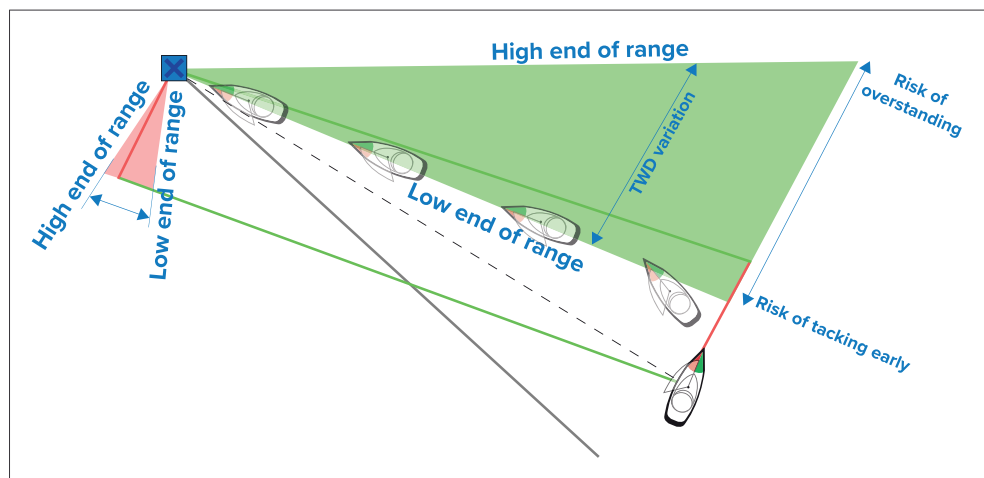

With TWD holding at the low end of its range of variation, the vessel can tack to starboard and will lay the windward or leeward mark when as it enters the shaded area. However, if TWD shifts back towards the higher end of its range of variation, the vessel will overstand the windward or leeward mark and may need to travel farther to reach the waypoint.

Variation — high end of range

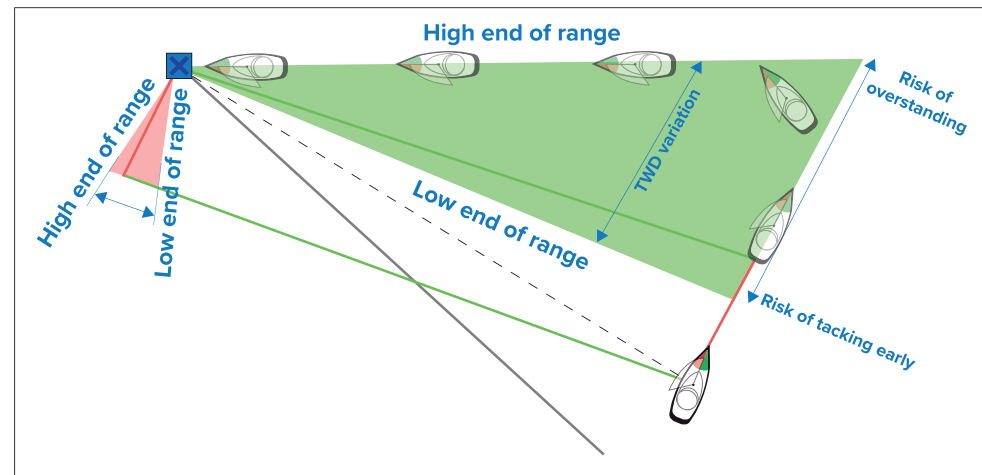

With TWD holding at the high end of its range of variation, the vessel can tack to starboard and will only lay the windward or leeward mark as it reaches the end of the shaded area. However, if TWD shifts back towards the lower end of its range of variation, the vessel will fall short of the layline and may have to perform extra tacks to reach the waypoint.

Depending on the situation, the normal course of action may be to tack when the vessel is halfway through the shaded area. However this may not be the shortest or quickest route.

Wind shift settings

Wind shift data settings are available from the *[Laylines]* settings page:

[Chart app > Settings > Laylines]



- *[Show wind shifts]*— Toggle wind shifts ON / OFF
- *[Time Period]*— Select the time period that you want the wind shift data to cover. The available options are:
 - 3 min

- 6 min (default)
- 12 min
- 30 min
- 60 min
- *[Reset]* — Reset the recorded wind shift data

20.3 Wind shift bar

When sailing, wind direction is very important, but does not remain constant in either strength or direction. To use the wind to your best advantage, when the wind direction shifts, the vessel heading should be adjusted accordingly, in order to follow a close-hauled course. LightHouse 4 automatically calculates the mean wind direction, allowing the Wind shift bar to provide an indication of changes in True Wind Direction (TWD) compared with the average TWD recorded over a specified time period.

This feature enables you to use the Wind Shift data display to identify the headers and lifts to help you decide when to tack or gybe.

The Wind shift bar is available when *Sailing* has been selected as the boating activity during the initial display start up wizard.

Wind shift time period — The period of time the wind shift data covers can be adjusted. The following time periods can be set: *3 min, 6 min (default), 12 min, 30 in and 60 min.*

Wind shift reset — The wind shift data can be reset which deletes the current stored data and restarts data collection.

The Wind shift bar can be displayed in the Chart app and in the Dashboard app.

Chart app:

The Wind shift bar can be displayed in *[Navigate]*, *[Racing]* and *[Anchor]* chart modes and is enabled by default in *[Racing]* chart mode.

In the Chart app, the Wind shift bar and Rudder bar cannot be displayed at the same time. When one is enabled, the other is disabled.

The Wind shift bar can be enabled and disabled from the *[Layers]* settings menu: *[Menu > Settings > Layers > Wind shift bar]*.

In the Chart app, the Laylines menu allows you to *[Reset]* the data and change the *[Time period]*.

Dashboard app:

In the Dashboard app, the Wind shift bar is included on the default Sailing page and includes a digital wind shift value.

In the Dashboard app, the Rudder bar and Wind shift bar are interchangeable. A Wind shift digital value data item can also be added to any Dashboard app page. The Wind shift digital data item is located in the Wind data category.

In the Dashboard app, the Wind shift bar pop-over options allow you to *[Reset]* the data and change the *[Time period]*.

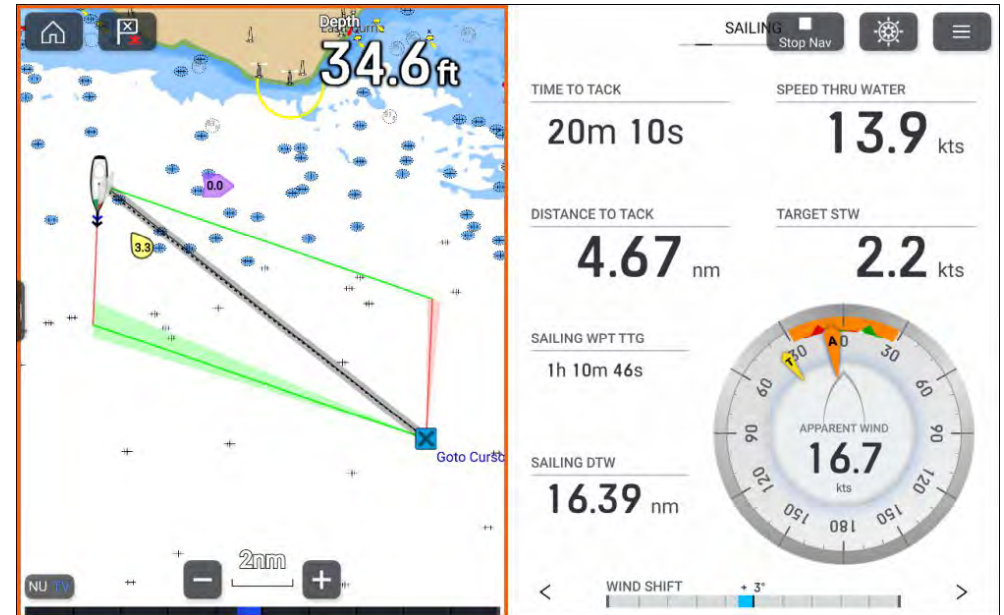

- When on a port tack, wind shifts to port are known as “lifts” and are shown as a positive value extending to the left.
- When on a port tack, wind shifts to starboard are known as “headers” and are shown as a negative value extending to the right.
- When on a starboard tack, wind shifts to starboard are “lifts” and are shown as a positive value extending to the right.
- When on a starboard tack, wind shifts to port are “headers” and are shown as a negative value extending to the left.

The same rules apply regardless of whether you are travelling upwind or downwind.

20.4 Sail plan recommendations

Sail plan recommendations published by your vessel's manufacturer can be displayed onscreen to help select the correct sail configuration for the prevailing wind conditions. The recommendations are updated in real time as Apparent Wind Speed (AWS) and Apparent Wind Angle (AWA) change.

The vessel's sail plan must first be defined in a simple spreadsheet. The spreadsheet defines a scale of Apparent Wind Speeds (AWS) and the proper main and headsails to be deployed when sailing upwind or downwind. The spreadsheet must then be saved as a Comma Separated Values (CSV) file.

Typically, the sail plan can be provided to you as a csv file by your vessel manufacturer. If this is not possible, a csv template can be downloaded from the Raymarine website, and used as a starting point: [Sail Plan Spreadsheet Template](#)

Sail plans in csv format can then be imported via the Sail Plan page: *[Boat details]* menu: *[Homescreen > Settings > Boat details > Sail plan]*.

The data of an imported sail plan can be viewed by selecting the plan.

Sail plan recommendations can be shown as:

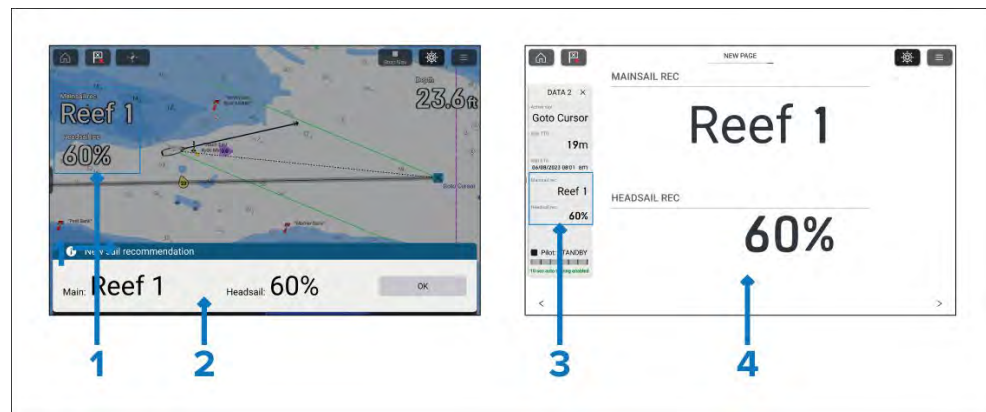

1. Data items in a data overlay.
2. Alert notification (if the *[Sail recommendation]* alarm is enabled).
3. Data items in the Sidebar.
4. Data items in the Dashboard app.

The sail plan recommendation data items are located under the *[Boat]* data category:

- *[Sail recommendation (Main)]*— single data item.
- *[Sail recommendation (Headsail)]*— single data item.
- *[Sail recommendation]*— dual data item (only available in the Dashboard app).

Note:

It will take approximately 2.5 minutes from display power up or when data becomes available for sail recommendations to be shown.

A 60 second rolling average is used to calculate Average Wind Speed (AWS).

Change monitor:

To ensure wind speed changes are genuine and persistent, changes will be monitored over a period of time before they are applied.

- When wind speed is increasing, changes to the sail plan recommendation may take approximately 1 to 1.5 minutes.
- When wind speed is decreasing, changes to the sail plan recommendation may take approximately 8 to 10 minutes.
- When upwind changes to downwind or vice versa, changes to the sail plan recommendation may take approximately 2 minutes.

Sail plan csv file layout

Sail plan csv files must be laid out as follows:

A Sail plan csv template is available to download from the following web page: <https://www.raymarine.com/en-gb/learning/online-guides/automatic-sail-plan-recommendations>

	A	B	C	D	E	F	G
1	70						
2	5	Full	Full	16	Full	Full	
3	23	Full	Full	20	Full	Full	
4	28	Reef 1	Full	24	Reef 1	Full	
5	33	Reef 1	75	30	Reef 2	75	
6	38	Reef 2	60	38	Reef 3	60	
7	45	Reef 2	40	45	Reef 3	40	
8	55	Reef 3	Storm Jib	55	0	25	
9	>	Trysail	0	>	0	0	
10							

- Upwind/Downwind crossover AWA** — Define the apparent wind angle above which the sail plan enters downwind mode.
- Upwind AWS kts** — Enter the upwind AWS band thresholds (For the maximum AWS value, use '>')
- Upwind Mainsail** — Enter each upwind band for the mainsail.
- Upwind Headsail** — Enter an upwind value for each band of the headsail.
- Downwind AWS kts** — Enter the downwind AWS band thresholds (For the maximum AWS value, use '>')
- Downwind Mainsail** — Enter each downwind band for the mainsail.
- Downwind Headsail** — Enter a downwind value for each band of the headsail.

Mainsail and Headsail parameters

The following parameters can be entered for the Mainsail and Headsail.

Mainsail	Headsail
Full	No 1
Reef 1	No 2
Reef 2	No 3
Reef 3	No 4
Reef 4	Heavy Weather Jib

Mainsail	Headsail
Trysail	Storm Jib
None	Full
100	100
80	80
75	75
60	60
50	50
40	40
25	25
20	20
0	0

Importing a sail plan

- Create a comma delimited csv file in the correct format.
- Save the CSV file to a memory card and insert the card into your MFD's card reader.
- Select the *[Import plan]* button from the *[Boat details]* settings menu: *[Homescreen > Settings > Boat details]*.
- Browse to the csv file on your memory card.
- Select the csv file.
- Select *[OK]* on the Sail plan imported notification.

The [Import plan] button will change to show the name of your imported plan (csv filename).

- Select the sail plan button to view its details.

Example imported sail plan recommendation

UPWIND 0-70°			DOWNWIND >70°		
AWS kts	Main	Headsail	AWS kts	Main	Headsail
0-5	Full	Full	0-16	Full	Full
5-23	Full	Full	16-20	Full	Full
23-28	Reef 1	Full	20-24	Reef 1	Full
28-33	Reef 1	75%	24-30	Reef 2	75%
33-38	Reef 2	60%	30-38	Reef 3	60%
38-45	Reef 2	40%	38-45	Reef 3	40%
45-55	Reef 3	Storm Jib	45-55	0%	25%
>55	Trysail	0%	>55	0%	0%

From the details page you can also *[Delete the plan]* and *[Import a new plan]*. Importing a sail plan will overwrite the existing plan.

20.5 Sailing data page

Sailing data and dials are available for display alongside laylines to help indicate which direction to turn in order to maximise your VMG (Velocity Made Good) to windward.

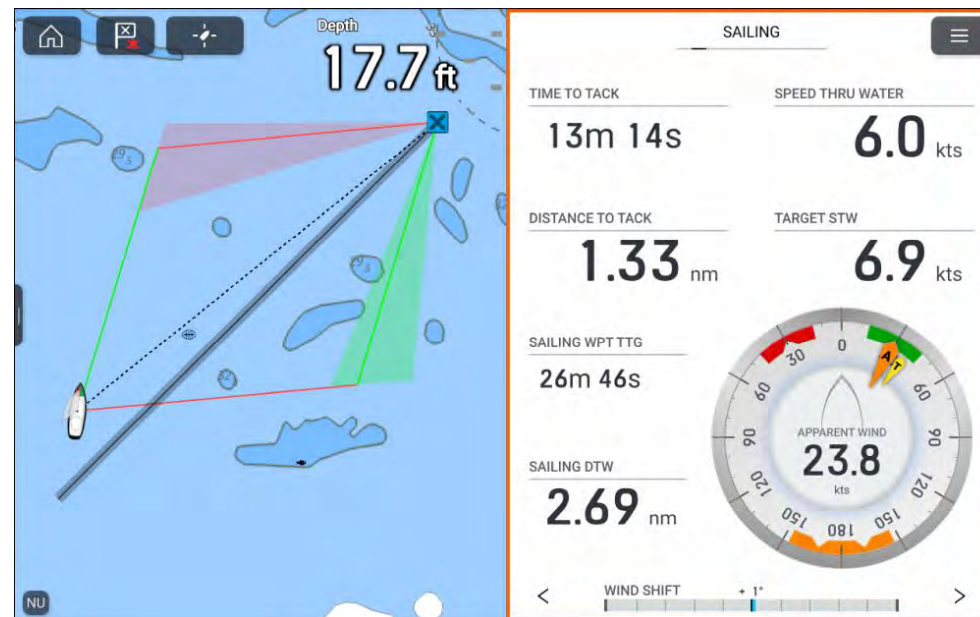

Sailing gauges can be displayed in the *[Dashboard app]* by selecting the Sailing default data page. For more information on customizing the Sailing data page, refer to [Chapter 25 Dashboard app](#)

20.6 Autopilot wind vane mode

Wind vane mode enables the vessel to 'steer to wind' using 1 of 3 wind datums, you can steer to either the Apparent Wind Angle (AWA), True Wind Angle (TWA) or to a target wind angle from a polar table.

Wind vane mode is available when the *Sailing* boating activity is selected during the initial start up wizard and wind data is available to the display.

The datums available are dependent on the *[Sail performance]* setting selected in the *[Boat details]* menu.

Wind vane mode is engaged from the Pilot sidebar by selecting *[Steer to Wind]*.

When Wind vane mode is enabled it will use the last used datum.

The datum can be changed by selecting the 'Steer to wind' data item at the top of the Pilot sidebar. The available datums are:

- *[Steer to True Wind Angle]* (TWA) — use TWA to maintain a fixed wind angle to the wind at any point of sail.
- *[Steer to apparent wind angle]* (AWA) — , use AWA to maintain a fixed wind angle to the wind at any point of sail.
- *[Steer to target wind angle (from polar)]* — Only available when the *[Sail performance]* settings is set to *[Polar]*. Use to achieve optimum upwind (or downwind) performance based on your polar.

Note:

[Steer to target wind angle (from polar)] is disabled if vessel heading is more than 10° from the polar target angle.

Mirrored TWA and Fixed angles

When *[Sail performance]* is set to either *[Mirrored TWA]* or *[Fixed angles]* then the datum can be set to TWA or AWA. In TWA and AWA the vessel will automatically steer towards the selected wind angle. The wind angle can be adjusted in 1 degree or 10 degree increments using the arrow buttons on the sidebar. If wind shift occurs, the autopilot will adjust the locked heading to maintain the original wind angle.

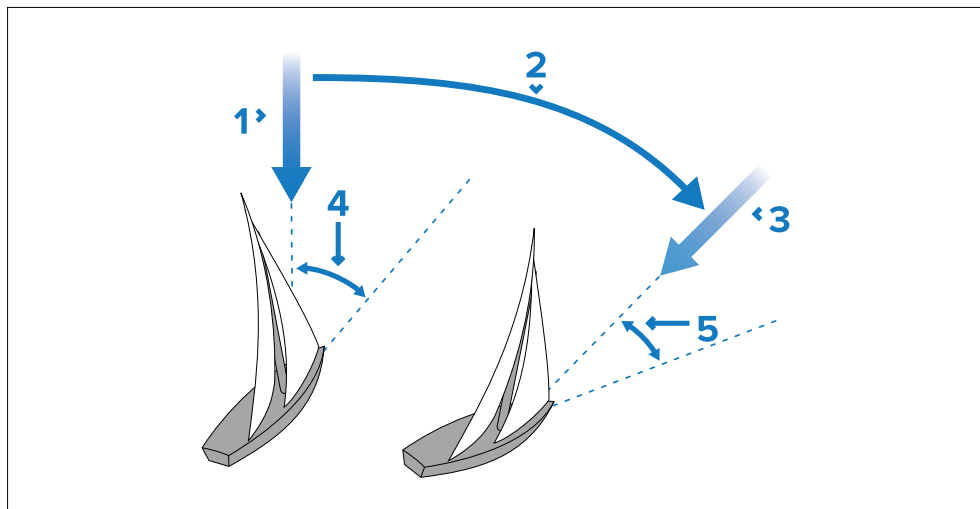

1. Initial wind direction.

2. Wind shift.
3. New wind direction.
4. Relative wind angle.
5. Vessel turns to maintain the same relative wind angle.

Target wind angle from polar

When the *[Sail performance]* is set *[Polar]* and the wind angle is within 10° of the polar target wind angle, the *[Target wind angle from polar]* option will be available. With this setting selected the vessel will automatically steer towards the relevant TWA based on current True Wind Speed (TWS) for the vessel speed specified in your polar table. The upwind or downwind, port or starboard target wind angle is used, depending on which is closest to current wind angle.

The system tries to use the closest target wind angle to the actual wind angle, if the target wind angle is more than plus or minus 10° from the actual wind angle the mode cannot be enabled.

The target wind angle can be adjusted in 1 degree increments using the arrow buttons on the sidebar. If the wind shifts or the wind angle is adjusted which means that the target wind angle is more than 10° from the polar target wind angle the mode will switch back to the previous used, i.e.: TWA or AWA.

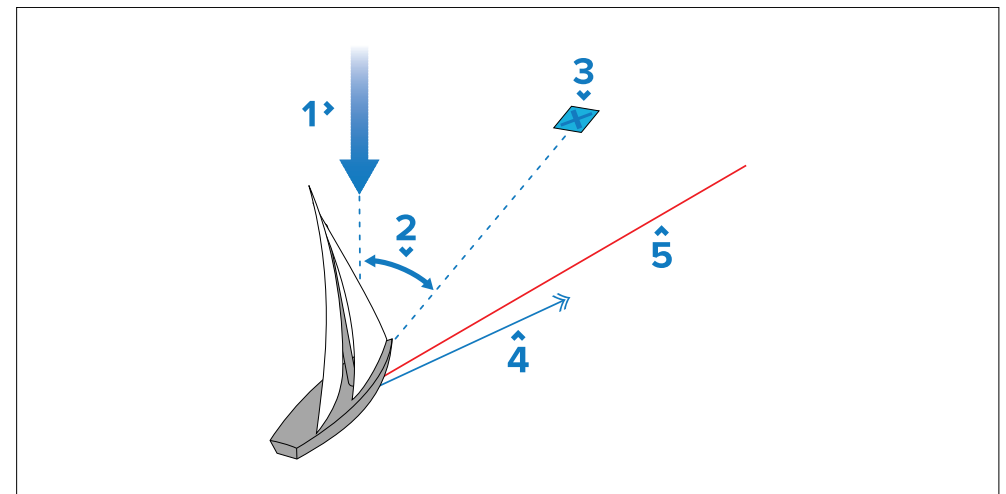

1. Wind angle.
2. Target wind angle.
3. Destination.

4. Course Over ground (COG).
5. Layline.

Operating hints for wind vane mode

- Always trim your sails carefully to minimize the amount of standing helm.
- Reef the headsail and mainsail a little early rather than too late.
- In Wind Vane mode the autopilot will react to long-term wind shifts, but will not correct for short-term changes such as gusts.
- In gusty and unsteady inshore conditions, it is best to sail a few degrees further off the wind so that changes in wind direction can be tolerated.

Caution: Allow time

Always allow adequate time for course changes.

Caution: Major course changes

When making major course changes, the trim on the boat may change substantially. Due to this, the autopilot may take some time to settle accurately onto the new course.

Tacking in wind vane mode

The Tack buttons can be used to Tack to the same offset angle on the opposite side of wind.

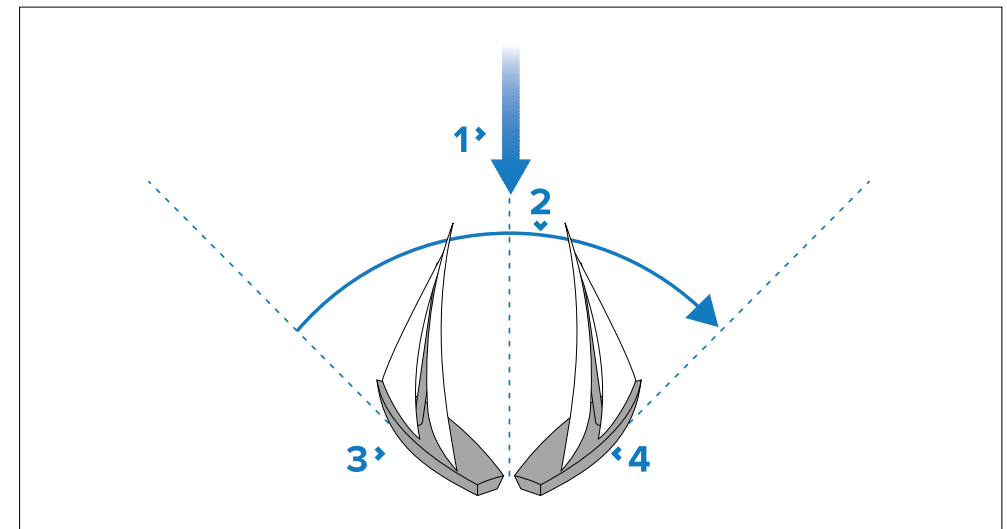

1. Wind direction.
2. Tack.
3. Starting position.
4. Final position.

Tacking is always relative to wind angle and is not adjustable.

Note:

Performing a Tack from the sidebar will always be through the wind. Gybes are prevented regardless of the *[Gybe inhibit]* setting.

Example:

- The *[Tack to port]* button is enabled if the locked wind angle is a port angle, the *[Tack to starboard]* button will be disabled.
- The *[Tack to starboard]* button is enabled if the locked wind angle is a starboard angle, the *[Tack to port]* button will be disabled.

Both buttons will be disabled if the locked wind angle is between 0 degrees to 5 degrees or 175 degrees to 180 degrees.

1. To Tack to port, select the *[Tack to port]* button from the Sidebar and then select *[Tack to port]* from the pop-over options.
2. To Tack to starboard, select the *[Tack to starboard]* button from the Sidebar and then select *[Tack to starboard]* from the pop-over options.

When you Tack in Wind vane mode, the vessel turns through the Tack angle. The autopilot will then adjust the heading to mirror the locked wind angle from the previous tack.

Steering to wind (autopilot)

You can use your autopilot to steer to a fixed wind angle.

1. Select the *[Pilot]* icon located at the top of the screen.
2. Select *[Steer to Wind]* from the Pilot sidebar.
3. Select *[Engage pilot]*.

Your vessel will maintain the current wind angle.

You can disengage the autopilot at anytime by selecting *[Disengage pilot]*.

20.7 Race start line (SmartStart™) and Race timer

The Race start line and Race timer features can help you achieve a better racing start. The features assist you in approaching the race start line at the optimum speed, angle and time.

The basic concept of an effective race start is to guide your vessel and tune the sail configuration in an optimum way to ensure you are approaching the start line at the very last moment with full power. In race sailing, the countdown to this last moment is known as “Time to burn”.

The Race start line and Race timer features are available when ‘Sailing’ is selected as the Boating activity during the initial MFD start up wizard.

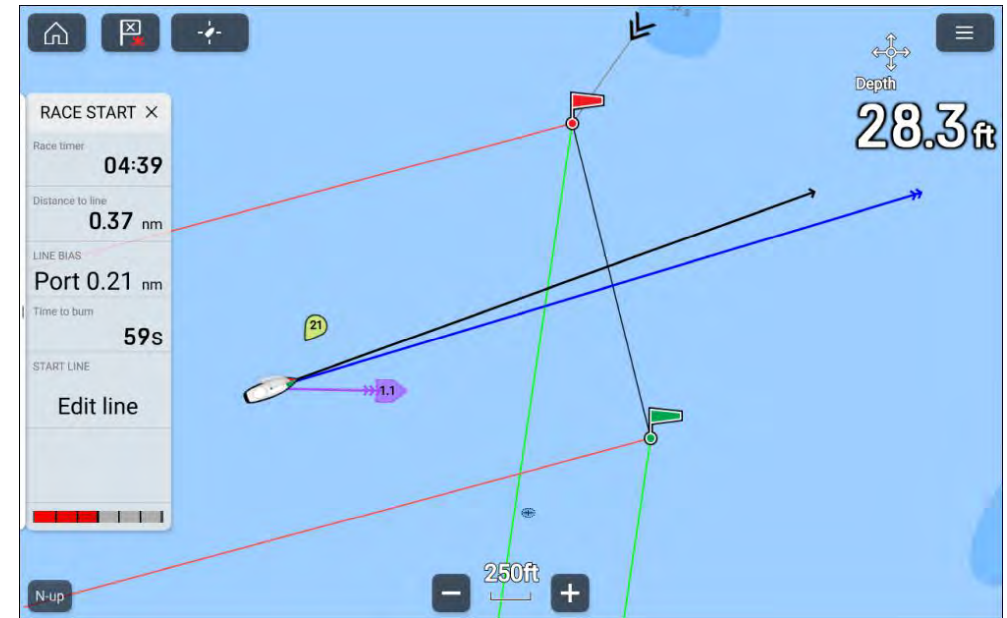

The Race start line feature provides a visual indication of the position of the start line on the chart, and provides key data, including Distance to start line, Line bias, and Time to burn data. These features can also be used in conjunction with Laylines to further assist you in optimizing your approach to the start line. When the Race start line, Race timer and Laylines are active, Laylines will visually protrude from the Race start line’s port and starboard ends to help guide your vessel on an optimum course to the start line.

For more information on Laylines, refer to: [p.286 – Laylines](#)

With the Chart app set to *[Racing]* mode the *[Race start line]* can be created by adding port and starboard ends using the chart context menu. The Race start sidebar’s Edit line option and the main menu’s Race start line option can be used to create a start line by pinging your vessel’s location when it reaches each end of the start line.

The Race start line visual graphics are displayed in *Racing mode* and *Navigate mode* in the Chart app.

The Race start line and Race timer data is displayed in the Race start sidebar and on the Dashboard app’s Race start data page. For more details on the Race start page refer to: [p.302 – Race start page](#)

The Race start timer is used to count down to the start of the race, once the timer reaches zero it will count up indicating the time since the race began.

The Race start timer can be controlled from the chart app main menu, Race start sidebar and Race start data page. The Race timer can also be added to any Dashboard app data page.

Creating the Race start line

A Race start line is created by placing port and starboard end points.

The end points can be created by:

- Placing them anywhere on the Chart app, or for greater accuracy, placing them using existing chart waypoints and chart objects (e.g. Buoys).
- Pinging your vessel's current location, using GNSS (GPS) receiver position data.

Once both end points have been entered, the Race start line will be drawn between the two points.

Creating a Race start line

Race start line end points can be placed anywhere on the Chart app. You can also use waypoints or chart objects to place Race start line end points at specific coordinates.

To create an end point on a waypoint or chart object:

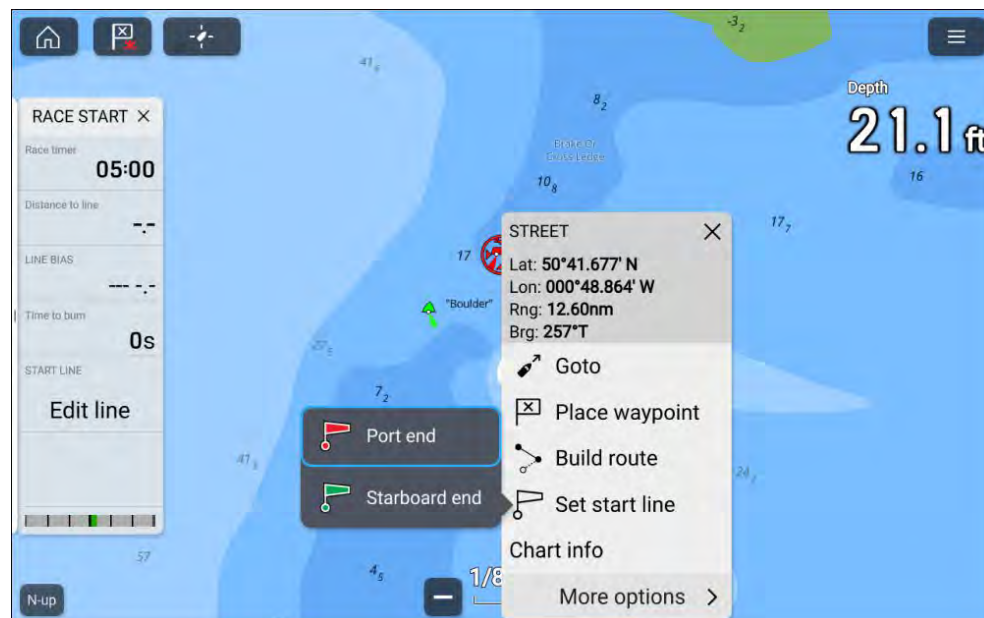

1. Select the waypoint or chart object to display the context menu.
2. Select *[Set start line]*.
3. Select *[Port end]* or *[Starboard end]*.
4. Repeat for the opposite end.

Pinging the Race start line

A Race start line can be created using your vessel's GNSS (GPS) position to ping each end of the Race start line.

Note:

The steps below are provided as an example, where the port end point is placed first. It does not matter which end point is placed first.

When your vessel is at an end point:

1. Select *[Edit line]* from the Race sidebar or *[Race start line]* from the Chart app's main menu while in Racing mode.
2. Select *[Ping Port end]*.

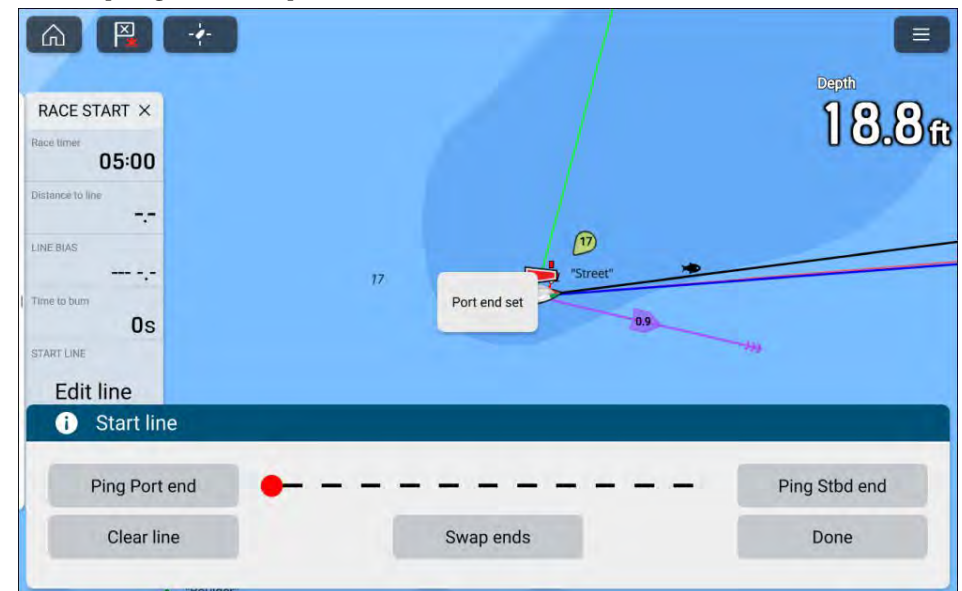

3. Manoeuvre to the opposite end point.

4. Select [Ping Stbd end].

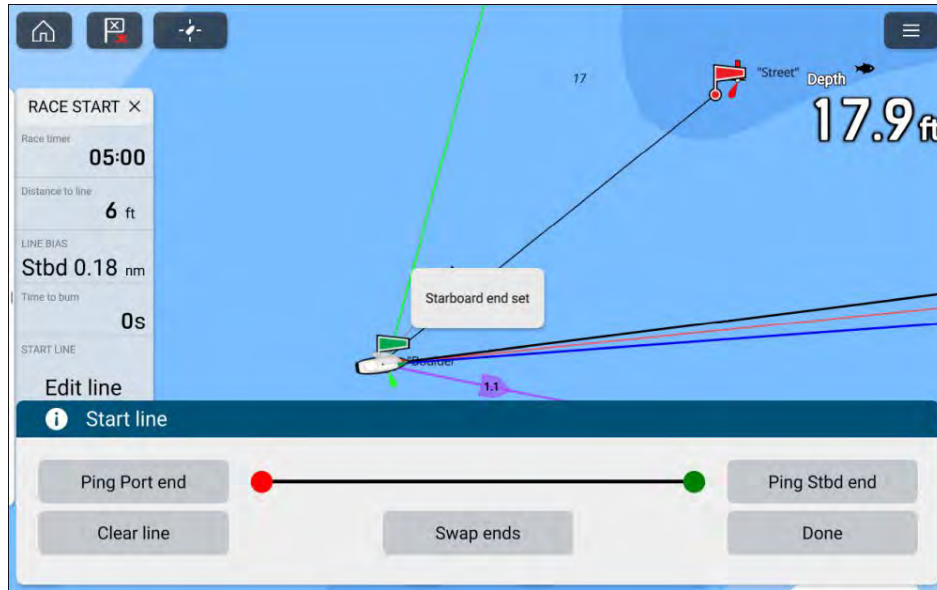

Editing and clearing the Race start line

The Race start line can be edited and deleted.

To edit the Race start line:

1. Select the line or end points on the chart app.
2. Select [Edit line].

From here you can choose to swap the positions of the Port and Starboard end points, re-pinging them to your vessel's current position, or clear the start line.

3. Select [Done] to save changes.

Starting the Race timer

A Race timer is used to count down until race start.

To start the Race timer:

1. Select [Race timer] from:
 - The Race start sidebar
 - The Chart app's main menu while in Racing mode
 - The Race timer data item in the Dashboard app.
2. Select [Timer duration] and set the countdown time (default is 5 minutes).

The Race timer can be set from 1 minute to 30 minutes.

3. Select [Start] to begin the countdown.
4. You can change the countdown time as well as stop and reset the timer by reopening the Race Timer options.

Important:

Pinging the Race start line ends will use your vessel's location (from an internal or external GNSS receiver). When pinging the end points, it is important to compensate for the distance between your vessel's bow and the GNSS receiver's location.

To increase the accuracy of start line placement:

1. Approach an end point from the same direction you will be traveling when starting the race.
2. Align your vessel so it is perpendicular to the end point.
3. When the bow of your vessel reaches the end point, ping the location.
4. Repeat for the alternate end, ensuring your vessel remains perpendicular to the line.

Race laylines

When the Race start line, Race timer and Laylines are active, laylines will protrude from the Race start line's port and starboard ends to help guide your vessel on an optimum course to the start line. A Favoured End Marker will also appear on the end point that provides a more competitive start. For more information on laylines refer to [20.2 Laylines](#)

The start line will appear differently depending on whether it is an upwind or downwind start:

- Upwind starts will show red and green laylines as well as a Favoured End Marker on the end point closer to the True Wind Direction (TWD).
- Downwind starts will show orange laylines as well as a Favoured End Marker on the end point farther from the True Wind Direction (TWD).

Race start page

The race start data page is available in the Dashboard app, when the MFD has been configured to use the Sailing boating activity during the initial MFD start up wizard. The race start page includes data relevant to race sailing and includes a graphical sailing dial.

The apparent wind dial is the default dial displayed on the race start page.

When the *[Sail performance]* setting has been configured dynamic wind angle targets will be displayed. The sail performance setting can be configured from the *[Boat details]* menu: *[Homescreen > Boat details > Sail performance]*.

If the *[Sail performance]* setting has not been configured then close hauled angle indicators are displayed instead of wind angle targets.

The race start page can be used in combination with the Laylines feature and race start line feature available in the chart app to optimize your sailing performance. For details about the layline features refer to:

- [p.286 — Laylines](#)
- [20.7 Race Start Line \(SmartStart\) and Race Timer](#)

Example — Race start page with apparent wind sailing dial

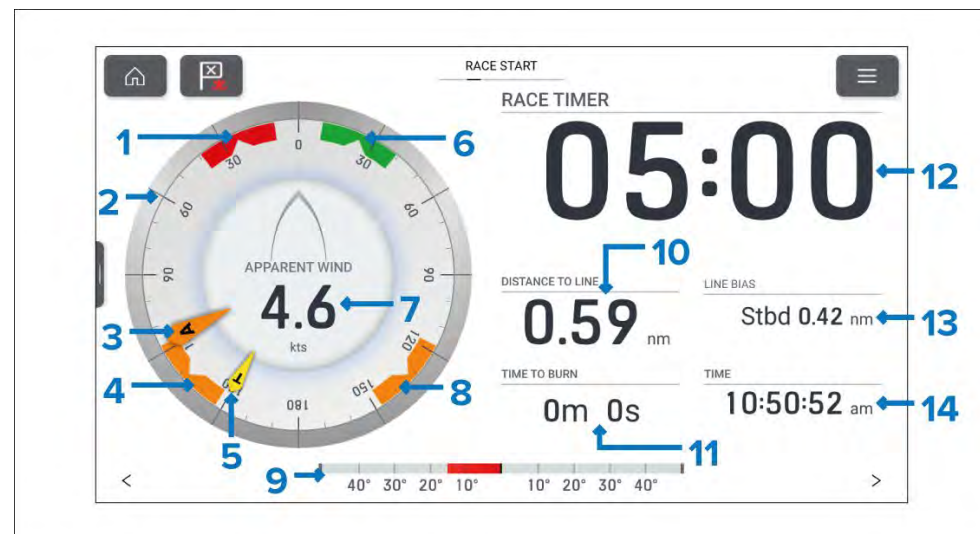

1. **Port wind angle target** — Align the larger wind indicator (AWA or TWA) with the notch to optimize Velocity Made Good (VMG) when tacking to port upwind.
2. **Compass dial** — The compass dial remains fixed and the indicators move around the dial to indicator direction/angle.
3. **AWA indicator** — Apparent Wind Angle.
4. **Downwind angle target** — Align the larger wind indicator (AWA or TWA) with the notch to optimize Velocity Made Good (VMG) when gybing downwind
5. **TWA indicator** — True Wind Angle.
6. **Starboard wind angle target** — Align the larger wind indicator (AWA or TWA) with the notch to optimize Velocity Made Good (VMG) when tacking to starboard upwind.
7. **Apparent wind speed**
8. **Downwind angle target** — Align the larger wind indicator (AWA or TWA) with the notch to optimize Velocity Made Good (VMG) when gybing downwind
9. **Rudder bar** — Provides an indication of rudder position.
10. **DISTANCE TO LINE** — Distance to your race start line.

11. **TIME TO BURN** — The time to wait to cross the start line at maximum speed.
12. **RACE TIMER** — Select the race timer to configure and start/stop the race timer.
13. **LINE BIAS** — Helps to determine the optimum point to cross the start line.
14. **TIME** — Current time.

The apparent wind dial can be changed to one of the alternative sailing dials. For details refer to:

The sailing dials are unique to default pages and cannot be reproduced on custom data pages.

Data items 10, 11, 13 and 14 can be customized. Data item 9 can be hidden if desired.

Race start sidebar

The Race start sidebar includes the following Race sailing related options and data.

Menu item and description	Options
<i>[Race Timer]</i> Displays the countdown time until race start. When the timer reaches 0 it will begin to count up, indicating how long it has been since race start.	<p>Before Start</p> <ul style="list-style-type: none"> • Start • Timer duration <p>During Countdown</p> <ul style="list-style-type: none"> • Sync nearest minute • Up 1 minute • Down 1 minute • Stop & reset <p>When Counting Up</p> <ul style="list-style-type: none"> • Stop & reset
<i>[Distance To Line]</i> Displays how far your vessel is from the closest point of the start line.	N/A

Menu item and description	Options
<i>[Line Bias]</i> Displays how much closer or further away the favoured endpoint is to the wind in comparison to the other endpoint.	N/A
<i>[Time To Burn]</i> Displays how much time you have before you need to navigate towards the start line. A negative value is shown if you are predicted to be running behind and will not be at the start line at race start.	N/A
	<ul style="list-style-type: none"> • If you are using polars for sail performance then speed from the polar diagram is used as the assumed starting speed through water. • If you are using fixed angles or mirrored TWA then you can manually set the expected speed or use your current speed by opening the race start line context menu (long pressing the start line).
<i>[Edit Line]</i> Allows you to edit the end points of the start line or clear it. You can ping the port or starboard end points to your current location as well as swap them.	<ul style="list-style-type: none"> • Ping Port end • Ping Stbd (starboard) end • Swap ends • Clear • Done

CHAPTER 21: FISHFINDER APP

CHAPTER CONTENTS

- 21.1 Sonar technologies — page 305
- 21.2 Sonar module range — page 309
- 21.3 Fishfinder app overview — page 309
- 21.4 Opening the Fishfinder app — page 311
- 21.5 Sonar transducer calibration — page 313
- 21.6 Sonar channels — page 314
- 21.7 Placing a Waypoint (Sonar, DownVision and SideVision) — page 315
- 21.8 Zoom mode — page 316
- 21.9 Fish detection — page 317
- 21.10 Sonar scroll back (history) — page 318
- 21.11 Sonar sensitivity controls — page 319
- 21.12 Frequency tuning — page 319
- 21.13 Fishfinder settings menu — page 320
- 21.14 Sonar display settings menu — page 320
- 21.15 Transducer settings menu — page 324
- 21.16 Sounder settings menu — page 324
- 21.17 Fish detection settings menu — page 325
- 21.18 Page settings menu — page 326

21.1 Sonar technologies

Traditional sonar technology

Traditional sonar uses a single carrier frequency or carrier wave for the sonar ping. The sonar works by measuring the time it takes the ping echo to return to the transducer to determine target depth.

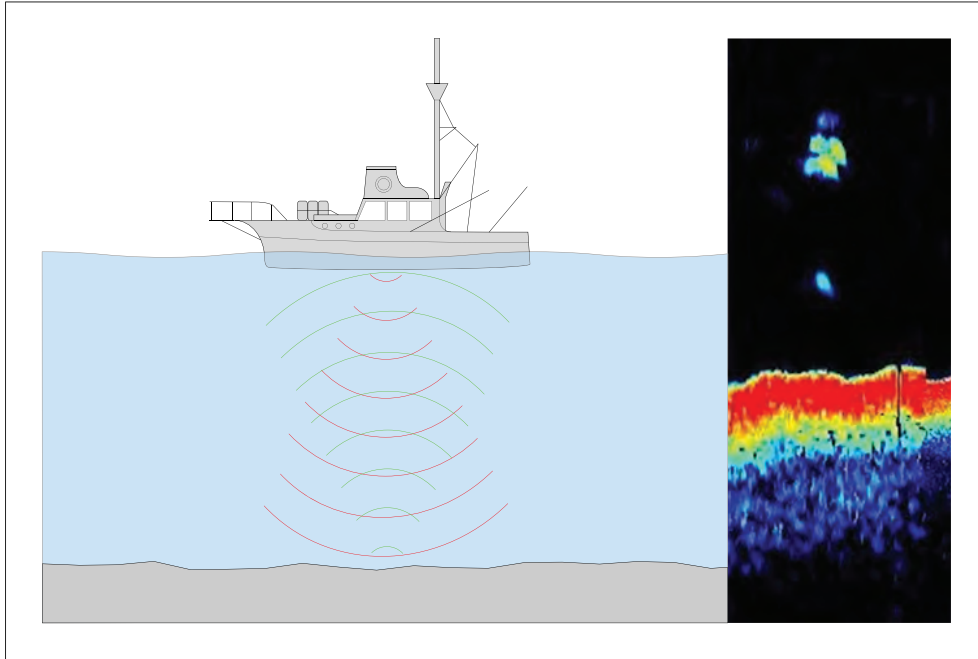

CHIRP technology

CHIRP (Compressed High Intensity Radar Pulse) sonar uses a swept frequency signal covering a wide range of frequencies which produces more accurate images with higher detail than traditional sonar.

Benefits of CHIRP sonar include improvements to target resolution, bottom detection (through bait balls and thermoclines) and detection sensitivity.

CHIRP is utilized by RealVision™ Max 3D, RealVision™ 3D, SideVision™ and DownVision™ transducers.

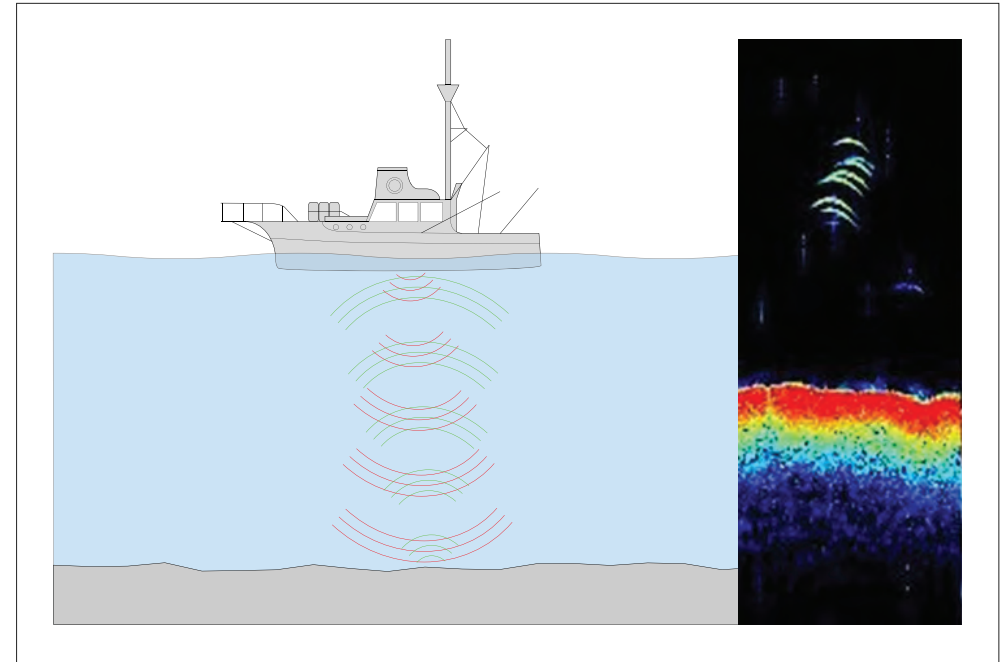

CHIRP Sonar overview

CHIRP sonar produces a conical shaped beam. The coverage of the conical beam is the water column directly beneath the vessel.

Conical beam

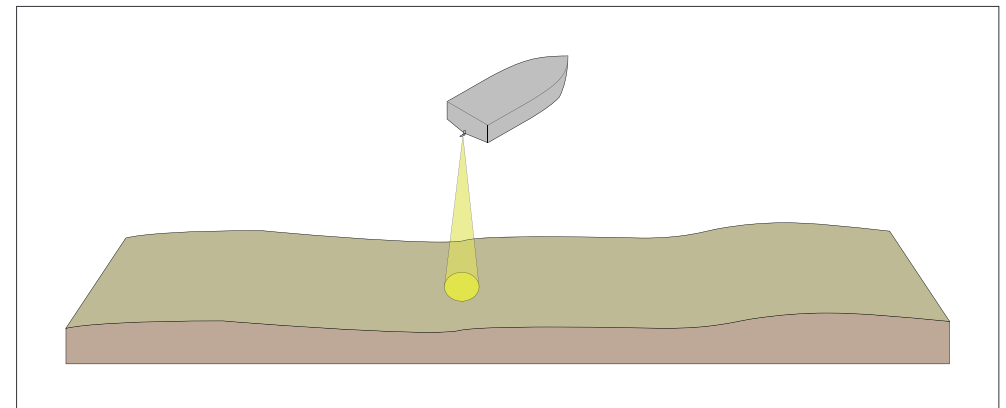

Sonar is effective at a range of speeds. In deeper waters the CHIRP bandwidth is automatically optimized to improve bottom lock and the detection of moving objects (e.g. fish) in the wider water column.

CHIRP sonar screen example

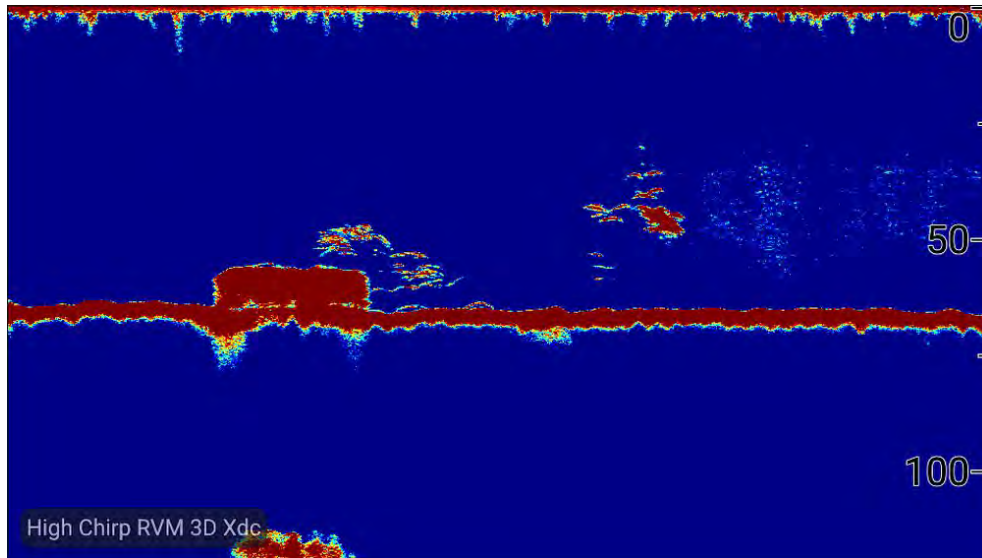

DownVision™ overview

DownVision™ produces a wide-angle side-to-side beam and a thin fore-to-aft beam. The coverage of the DownVision™ beam is a water column directly beneath and to the sides of the vessel.

DownVision™ beam

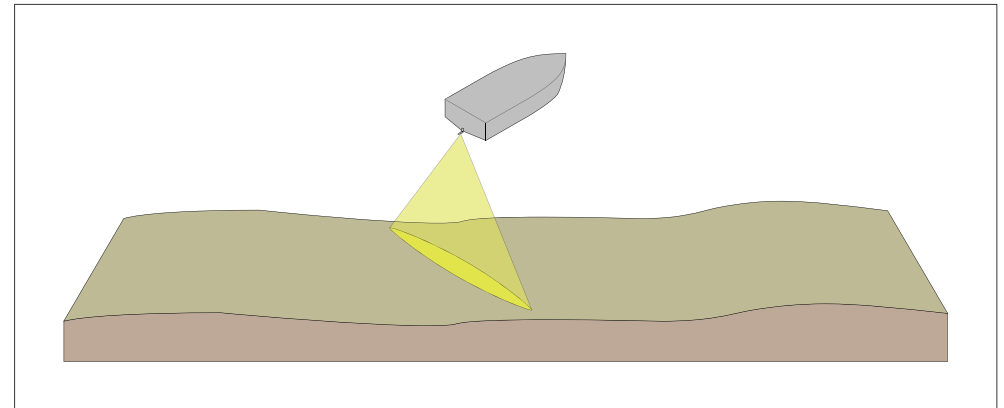

DownVision™ is effective at lower vessel speeds. In deeper waters the CHIRP bandwidth is automatically optimized to improve bottom lock and the detection of moving objects (e.g. fish) in the wider water column.

The wide, thin beam produces clear target returns. The use of CHIRP processing and a higher operating frequency provide a more detailed image, making it easier to identify bottom structures around which fish may reside.

DownVision™ screen example

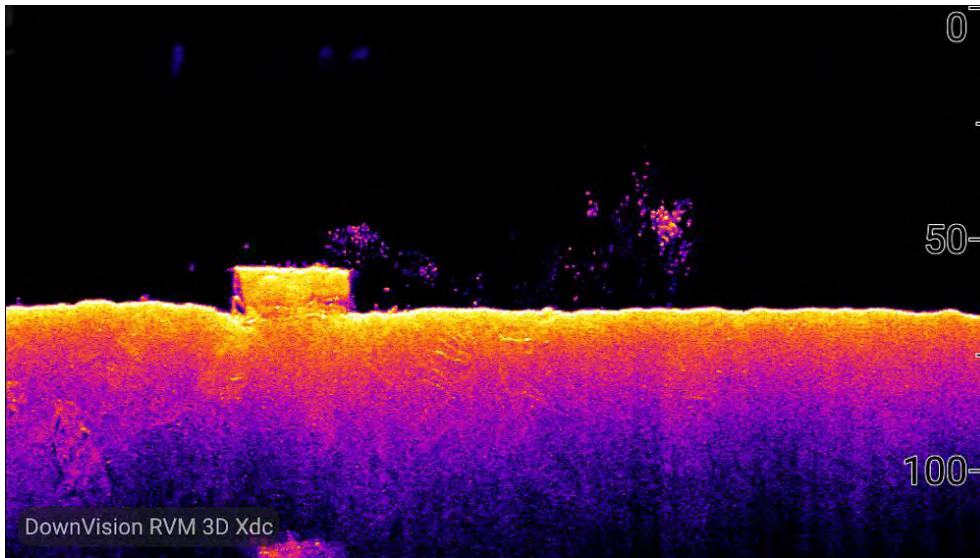

SideVision™ overview

SideVision™ transducers are side looking transducers that produce 2 wide-angle side-to-side beams, each with a thin fore-to-aft beam to build up a detailed underwater view as your vessel moves forward.. The coverage of the SideVision™ beams is an area to both side of your vessel.

SideVision™ beams

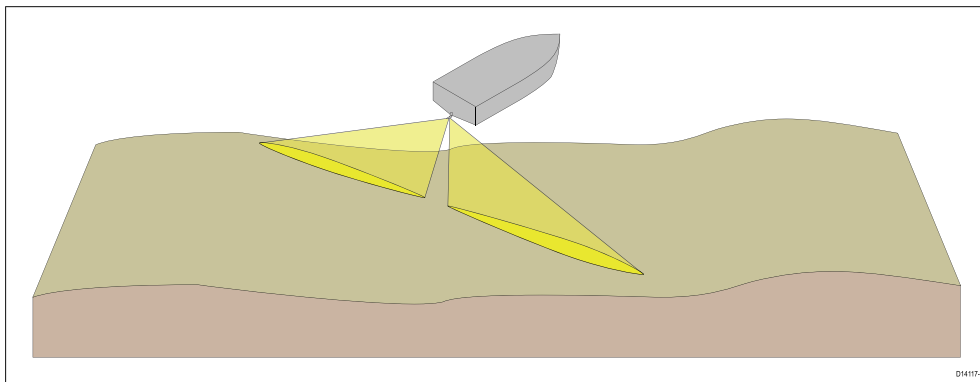

The transducers send pulses of sound waves into the water on each side of your vessel, and records the sound waves that are reflected off objects suspended in the water column and the bottom,, known as sonar returns.

[Fishfinder app](#)

The sonar image is constructed line-by-line, similar to the way a television picture is composed of many horizontal lines. Each successive ping from the transducer adds a new line of image data to the top of your display. Each new line shows sonar returns from both the port and starboard sides of your vessel. As new lines are added with each successive ping, older data gradually scrolls down the display, building up a detailed image of the water column and bottom to the sides of your vessel. If your vessel maintains the same bearing and speed for a period of time, you can interpret the image as a plan of the bottom along your vessel's course. SideVision™ is effective at lower vessel speeds.

Note:

SideVision™ does not provide direct depth readings. The scale shown across the top of the image indicates the distance of features from your vessel.

SideVision™ screen interpretation

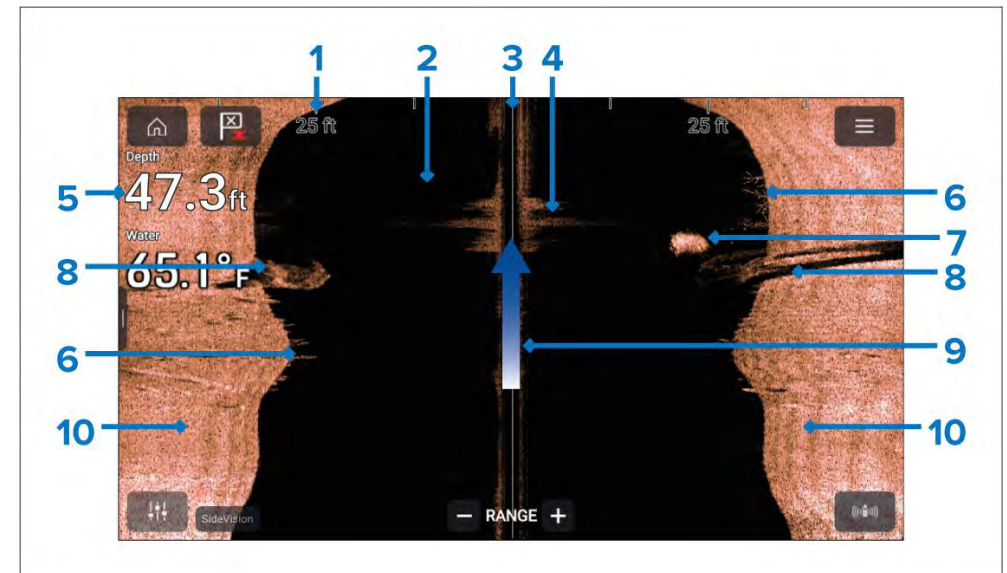

1. **Range scale** — The range scale indicates distance (range) to port and starboard from your vessel.
2. **Water** — Using the default color palette black indicates no sonar returns i.e.: clear water.

3. **Centerline** — The solid line represents the centerline of your vessel. left of the centerline represents the water, objects and bottom to the port side of your vessel, right of the centerline represents the starboard side.
4. **Turbulent water** — turbulence in the water caused by such things as vessel wake can produce a sonar return due to the aeration in the water.
5. **Water depth** — When using a separate depth transducer current depth can be displayed in a data overlay.
6. **Vegetation** — Examples of vegetation growth (e.g: trees) on the bottom.
7. **Bait ball** — Example of a bait ball at an approximate distance of 18.5 ft from your vessel.
8. **Structure** — Example of bottom structure. Underwater structures such as pipelines, piers and other large solid structures may cause an area of shadow directed away from your vessel's direction.
9. **Vessel direction** — Vessel direction of travel. The sonar image will scroll from top to bottom as your vessel moves.
10. **Bottom** — Solid mass indicating the bottom, using the default color palette the bottom is colored copper. It may be possible to identify the transition of bottom material (e.g.: where an area of mud meets an area of gravel).

RealVision™ 3D overview

RealVision™ 3D and RealVision™ Max 3D transducers produce life-like 3D sonar imagery. When using a RealVision™ 3D or RealVision™ Max 3D transducer the [3D Vision] channel will be available in the Fishfinder app. RealVision™ 3D and RealVision™ Max 3D transducers are also capable of producing DownVision™, SideVision™ and CHIRP conical sonar channels.

3D Vision provides a true, easy-to-understand view of bottom topography, debris, and fish.

3D Vision screen interpretation



1. **Vessel location** — The vessel icon indicates location and direction of your vessel.
2. **Range scale** — The range scale indicates distance (range) to port and starboard from your vessel.
3. **Water line** — The line represents the top of the water.
4. **Depth indicator** — Provides an indication of object depths.
5. **Structure** — Example of bottom structure. Underwater structures such as pipelines, piers and other large solid structures.
6. **Sonar returns** — Sonar return/detected object.
7. **Bottom** — Solid mass indicating the bottom. It may be possible to identify the transition of bottom material (e.g.: where an area of mud meets an area of gravel).

21.2 Sonar module range

Range capabilities of Raymarine transducers/sonar channels are shown below.

Transducer / sonar channel	Range
RealVision™ 3D (3D Vision)	0.6 m (2 ft) to 91 m (300 ft)
SideVision™	0.6 m (2 ft) to 91 m (300 ft) each side
DownVision™	0.6 m (2 ft) to 183 m (600 ft)
CHIRP sonar channel (when using RealVision™ 3D, SideVision™ or DownVision™ transducers)	0.6 m (2 ft) to 274 m (900 ft)
CHIRP sonar channel (when using RealVision™ Max 3D transducer.	0.6 m (2 ft) to 366 m (1,200 ft)
Traditional 600 W sonar	0.9 m (3 ft) to 914 m (3,000 ft)
CHIRP 1 kW sonar	0.9 m (3 ft) to 914 m (3,000 ft)
Traditional 1 kW sonar	0.9 m (3 ft) to 1,524 m (5,000 ft)
CHIRP 2 kW sonar	0.6 m (2 ft) to 3,048 m (10,000 ft)

Note:

Stated ranges are for optimum conditions and are dependent upon connected transducer.

Sonar minimum depths

Accurate bottom tracking can be unreliable in depths shallower than 0.8 m/2.62 ft. When operating at or below this depth be cautious of misleading sonar returns, false bottom tracking and incorrect depth readings

The Minimum sonar depth alarm is triggered when your vessel reaches or is in water shallower than this depth.

Below are examples of the Sonar app when it is tracking a false bottom in shallow waters.

[Fishfinder app](#)

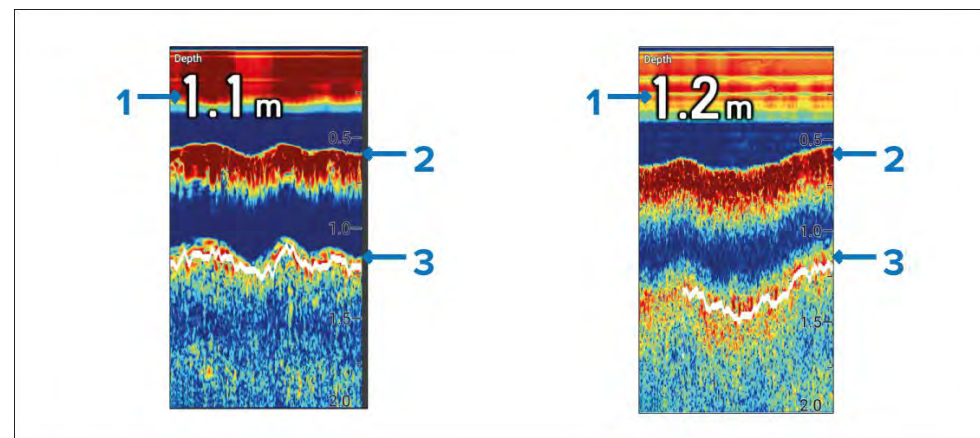

1. Examples of incorrect depth readings due to false bottom tracking.
2. Actual bottom tracking and water depth.
3. False bottom tracking providing false depth readings.

21.3 Fishfinder app overview

The Fishfinder app displays a visualization of the echoes received from a Sonar module and transducer. The Fishfinder app is compatible with Traditional, CHIRP, DownVision™, SideVision™ and RealVision™ 3D sonar modules and transducers. The Fishfinder app builds an underwater view of bottom structure and targets in the water column.

Multiple Sonar modules can be connected at the same time. Sonar modules can be internal (built-in to your MFD) or external (a separate box on your network).



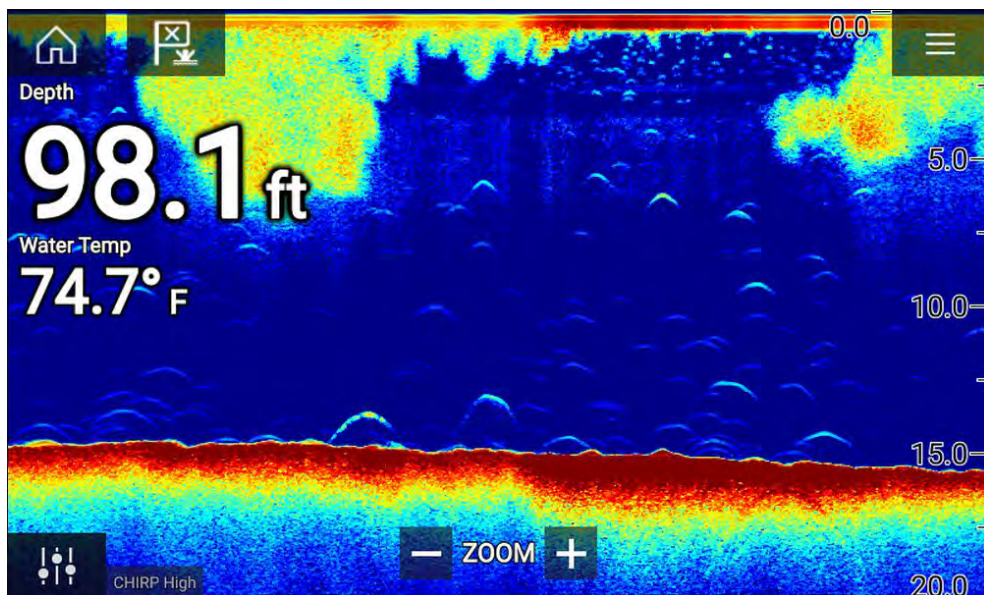

For each instance of the Fishfinder app you can select which Sonar module and channel that you want to use, the Sonar module and channel selection will persist over a power cycle.





The Fishfinder app can be displayed in both Fullscreen and splitscreen app pages. App pages may consist of up to 4 instances of the Fishfinder app.

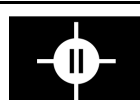

Fishfinder app controls

The Fishfinder app includes the following onscreen controls.

Icon	Description	Action
	Home icon	Takes you to the Homescreen
	Waypoint / MOB	Place waypoint / activate Man overboard (MOB) alarm
	Pilot icon	Opens and closes the Pilot Sidebar
	Menu icon	Opens the app menu

Icon	Description	Action
	Image adjustment	Displays onscreen sensitivity / image adjustment controls
	Pause	Pause 3D Vision sonar image.
	Unpause	When the Fishfinder app is paused, you can recommence scrolling by selecting the Unpause icon.
	Range/Zoom In	When <i>[Auto range]</i> is enabled, pressing the plus icon activates Zoom mode, subsequent presses will increase the Zoom factor. When Range is set to Manual pressing the Plus icon decreases the distance displayed onscreen. Auto range can be enabled and disabled from the Menu: <i>[Menu > Auto range]</i> .
	Range/Zoom Out	When in Zoom mode, pressing the minus icon will decrease the Zoom factor and finally revert to normal mode. When Range is set to Manual pressing the Minus icon increases the distance displayed onscreen.

Touchscreen controls

- Pinch-to-zoom changes switches to Zoom mode.
- The Range control determines how far the sonar will ping.
- Press and hold onscreen to display the context menu.

3D Vision channel controls

When using the 3D Vision channel you can manipulate the view using touch gestures.

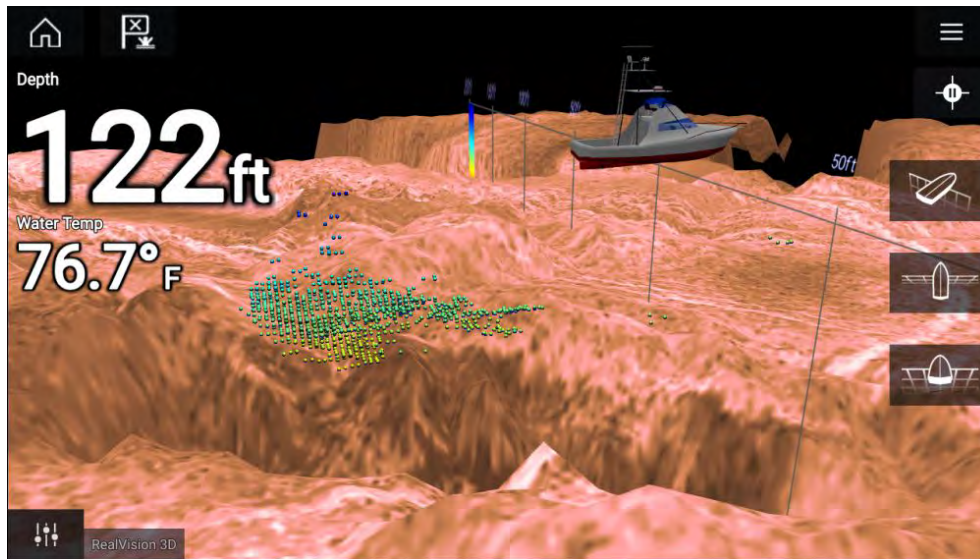

Touchscreen controls

- One finger swipe rotates the image.
- Two finger swipe pans the image around the screen.
- Pinch-to-zoom changes the magnification of the image.
- The Range control determines how far the sonar will ping.
- Press and hold onscreen to display the context menu

Physical buttons

- *[OK]* button pauses Sonar scrolling.
- *[Back]* button resumes Sonar scrolling.
- *[OK]* button when paused opens the context menu.
- Use the Uni-controller's *[Directional]* (Up, Down, Left, Right) controls to rotate the image.
- Use the Uni-controller's *[Rotary]* control or a RMK's *[Range In]* and *[Range Out]* buttons to Range in and out.

21.4 Opening the Fishfinder app

The Fishfinder app is opened by selecting a page icon from the Homescreen that includes a Fishfinder app.

Pre-requisites:

1. Ensure your Sonar module is compatible (check the latest details available on the Raymarine website). If in doubt contact an authorized Raymarine dealer for advice.
2. Ensure you have installed your Sonar module in accordance with the documentation that was supplied with the module.

The Fishfinder app will open in 1 of 4 states:

Please select a sonar channel

The first time you open a new app page that includes the Fishfinder app you will need to select a Sonar channel.

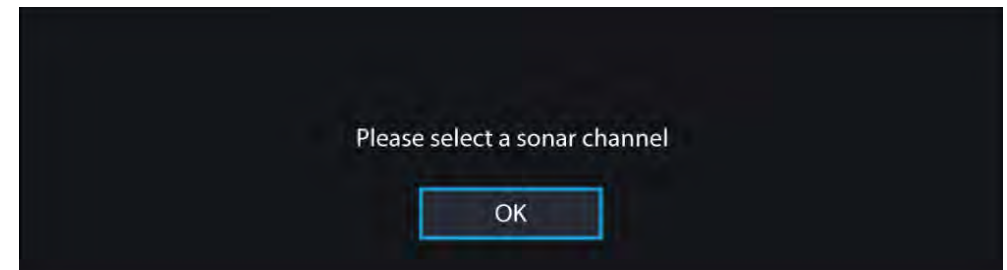

Select *[OK]* and then choose the Sonar channel you want to use from the list:

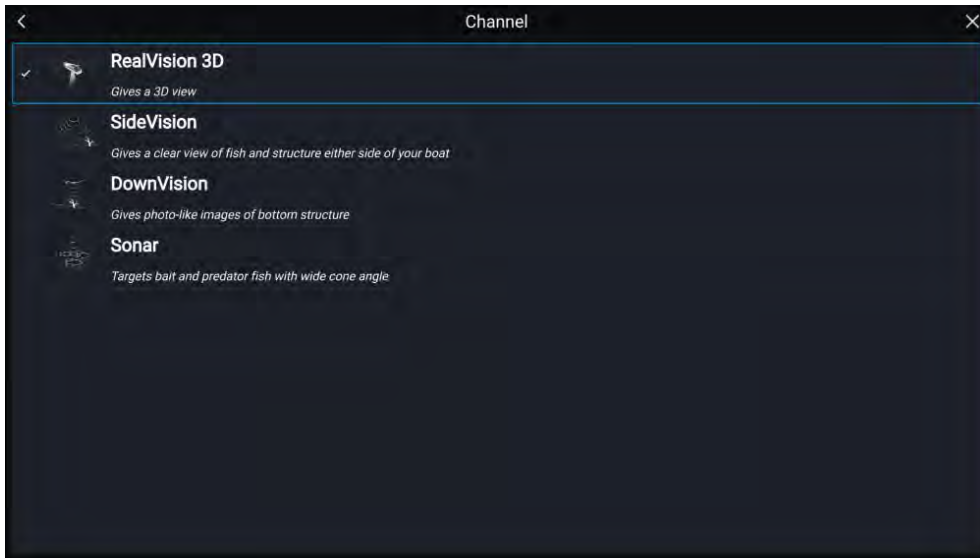

Sonar on and pinging

If your Fishfinder app has already been set up then when the Fishfinder app is opened the Sonar image will be displayed and start scrolling.

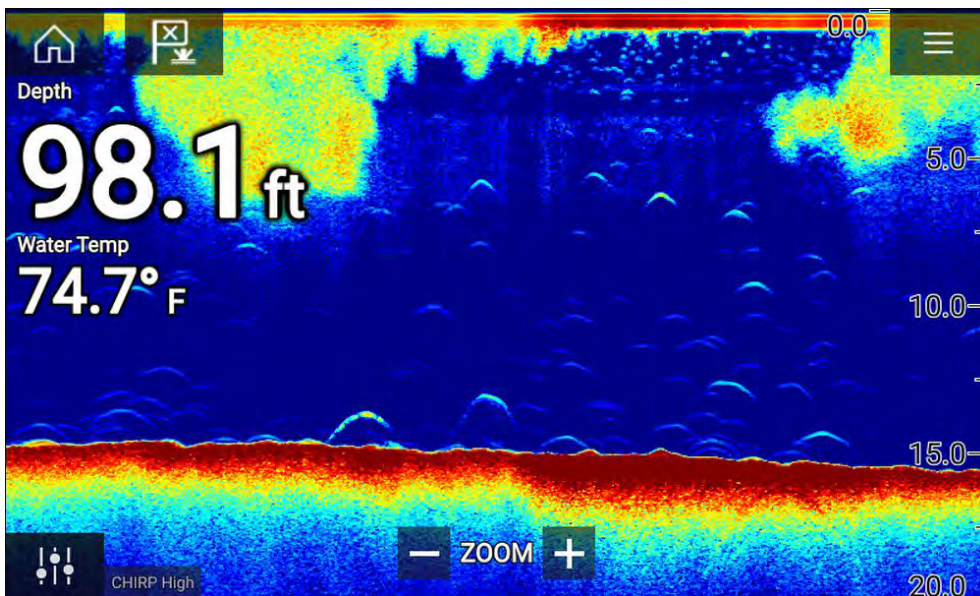

No sonar source available

If the 'No sonar source available' warning is displayed then either:

- your sonar module is still powering up.
- your MFD cannot establish a connection with your external Sonar module
- your Internal Sonar module has no transducer connected.

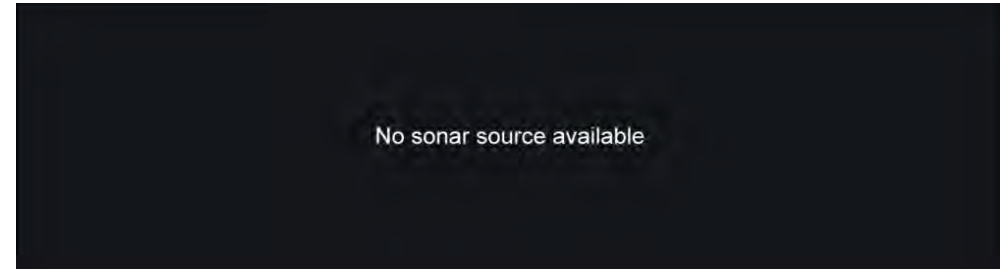

Check your external sonar module's network and power connection, check your MFD's network or transducer connection ensuring the connections and cabling is correct and free from damage, then power cycle your system. If the Sonar module is still not found then refer to your equipment's installation documentation for further troubleshooting information.

No transducer connected

If the 'No transducer connected' warning is displayed then your Sonar module cannot connect to your transducer.

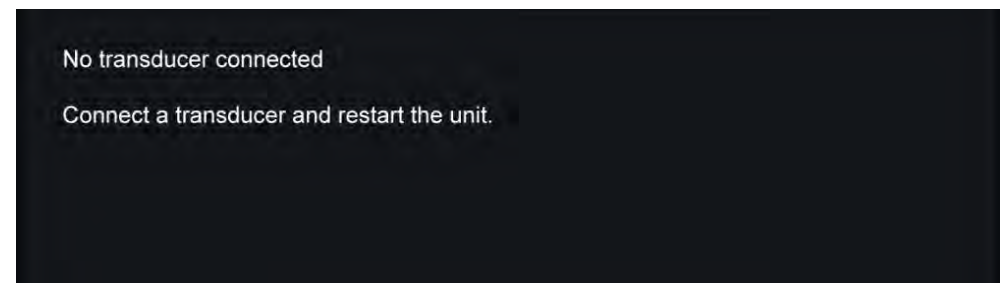

Check your transducer connection(s) are correct and free from damage, then power cycle your system. If the transducer is still not found then refer to your equipment's installation documentation for further troubleshooting information.

21.5 Sonar transducer calibration

Sonar transducers should be calibrated to ensure accurate readings are displayed on the MFD.

Depth offset

Depths are measured from the transducer face to the bottom (e.g.: seabed). An offset value can be applied to the depth data so that the displayed depth reading represents the depth reading taken from either the keel (negative offset) or the waterline (positive offset).

Before setting a waterline or keel offset, establish the vertical distance between the transducer and waterline or the bottom of your vessel's keel, as appropriate. Then set this distance as the depth offset value.

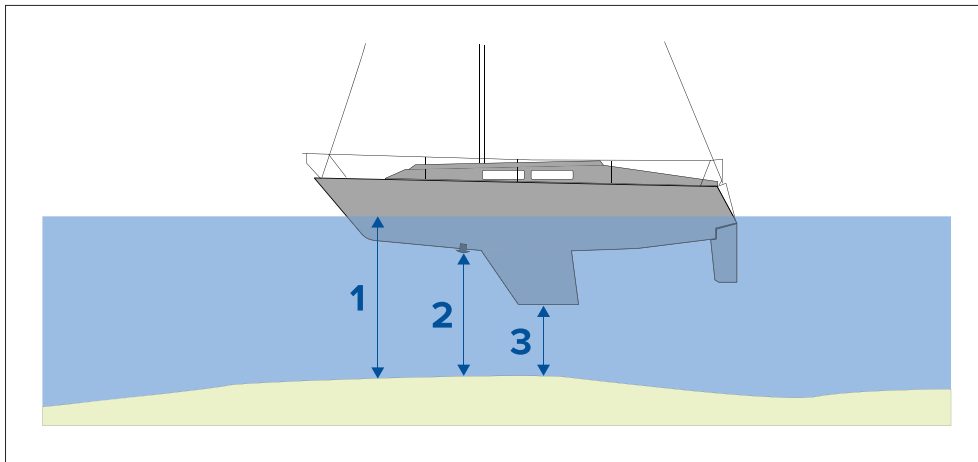

1. *[Below waterline]*— The depth reading will be increased from the transducer's default reading.
2. *[Below transducer]*— This is the default reading from the transducer (zero offset applied).
3. *[Below keel]*— The depth reading will be decreased from the transducer's default reading.

Setting a depth offset

You can set the point depth readings are taken from.

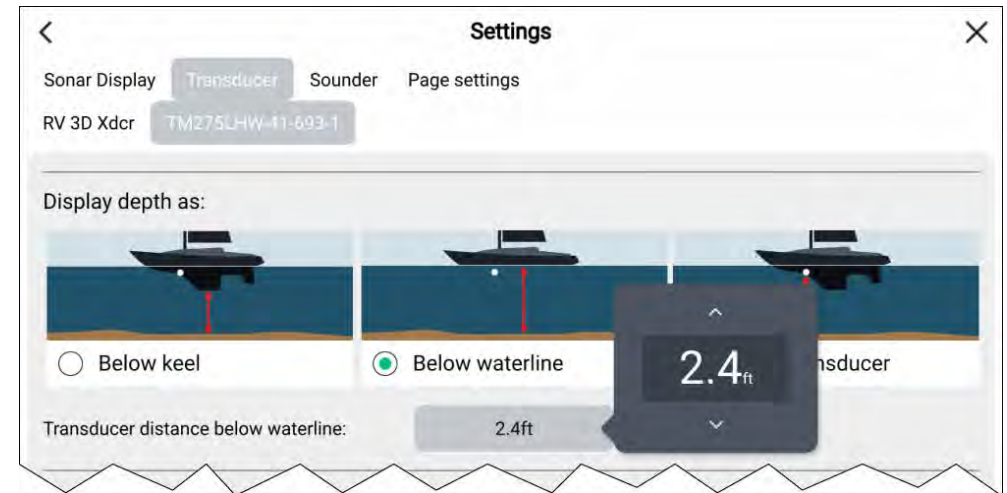

1. Open the *[Fishfinder app]*.
2. Open the *[Transducer]* settings menu: *[Menu > Settings Transducer]*.
3. If you have more than 1 sonar transducer installed, then you will need to select the relevant transducer.
4. Select either *[Below keel]*, *[Below waterline]*, or *[Below transducer]* as required.
 - i. If you have selected *[Below keel]* enter your transducer's distance above the lowest point of your keel in the offset field.
 - ii. If you have selected *[Below waterline]* enter your transducer's distance below the waterline in the offset field.

Setting a temperature offset

If your sonar transducer includes a temperature sensor then you can check and calibrate your temperature reading.



1. Open the *[Fishfinder app]*.
2. Open the *[Transducer]* settings menu: *[Menu > Settings Transducer]*.
3. If you have more than 1 sonar transducer installed, then you will need to select the relevant transducer.
4. If required, select the *[Enable temperature sensor]* toggle switch to enable the sensor.
5. Measure the actual water temperature using a thermometer.
6. Check your reading against the displayed *[Current temperature]*.
7. If the readings are not the same, select *[Calibrate temp]* and enter the difference between your 2 readings.

Ping depth limit

When high-powered transducers are searching for a bottom lock, they can search down to a maximum of 3,048 m (10,000 ft), during the sonar's hunt cycle. This means it can take some time to acquire or re-acquire a bottom lock. To help improve sonar bottom lock re-acquisition time on high powered transducers, a ping depth limit can be set.

When using a CHIRP or non-CHIRP high power (greater than 600 W) transducer connected to the 1 kW transducer, the *[Ping depth limit]* control will be available in the Fishfinder app's *[Transducer]* settings menu: *[Menu > Settings > Transducer > Ping depth limit]*.

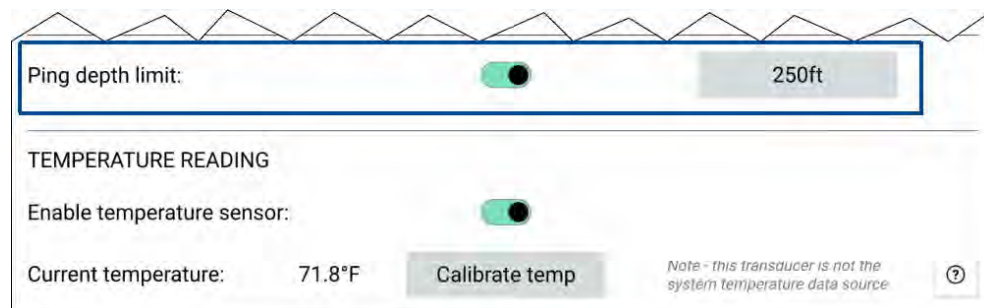

Important:

- The *[Ping depth limit]* should only be enabled when problems are experienced re-acquiring depth readings after the sonar has lost depth readings.
- Once *[Ping depth limit]* is enabled, when sailing in waters deeper than the specified depth limit, the Fishfinder app / transducer will not be able to establish a depth reading / bottom lock.

The Ping depth limit control enables you to specify a depth limit that your sonar will search down to. It is recommended this limit is set to a depth of approximately 25% to 50% deeper than the maximum water depth you want to use your Fishfinder in. E.g.: In 200 ft max depth water, the ping depth limit should be set between 250 ft and 300 ft.

21.6 Sonar channels

The sonar channels that are available depend on the Sonar module and transducer you have connected.

The sonar channels that may be available are:

- *[3D Vision]*
- *[SideVision]*
- *[DownVision]*
- *[High CHIRP]*
- *[Medium CHIRP]*
- *[Low CHIRP]*
- *[High Tuned]*
- *[Medium Tuned]*
- *[Low Tuned]*
- *[200 kHz]*
- *[100 kHz]*
- *[50 kHz]*

Selecting a Sonar channel

The first time you open a new Fishfinder app page you will be requested to select a channel, subsequently you can change the sonar channel by selecting a channel icon from the Fishfinder app menu.

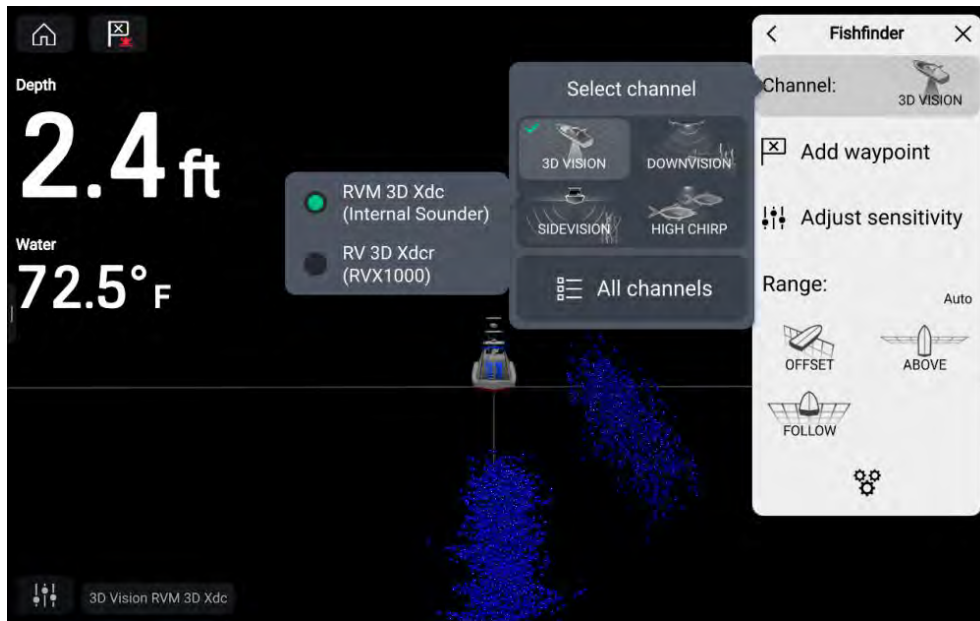

From the Fishfinder app menu:

1. Select *[Channel:]*
2. Select then icon for the sonar channel you want to display.
3. Select the transducer you want to use for the selected sonar channel.
Only applicable if you have more than one transducer capable of producing the selected sonar channel.
4. Alternatively, select *[All channels]* from the Channel pop-over options and then choose your desired sonar module and channel.

The channel and transducer in use is identified in the bottom left corner of the screen.

21.7 Placing a Waypoint (Sonar, DownVision and SideVision)

When you observe something of interest in the Fishfinder app you can place a waypoint at its location so that you can find the area again.

1. Select and hold on the point of interest onscreen.
The Context menu is displayed and scrolling is paused, temporarily.
2. Select *[Add Waypoint]* from the context menu.

The Sonar image will remain paused for approximately 10 seconds after the Waypoint has been placed.

Placing a waypoint in the 3D Vision channel

To place a waypoint whilst viewing a [3D Vision] channel follow the steps below.

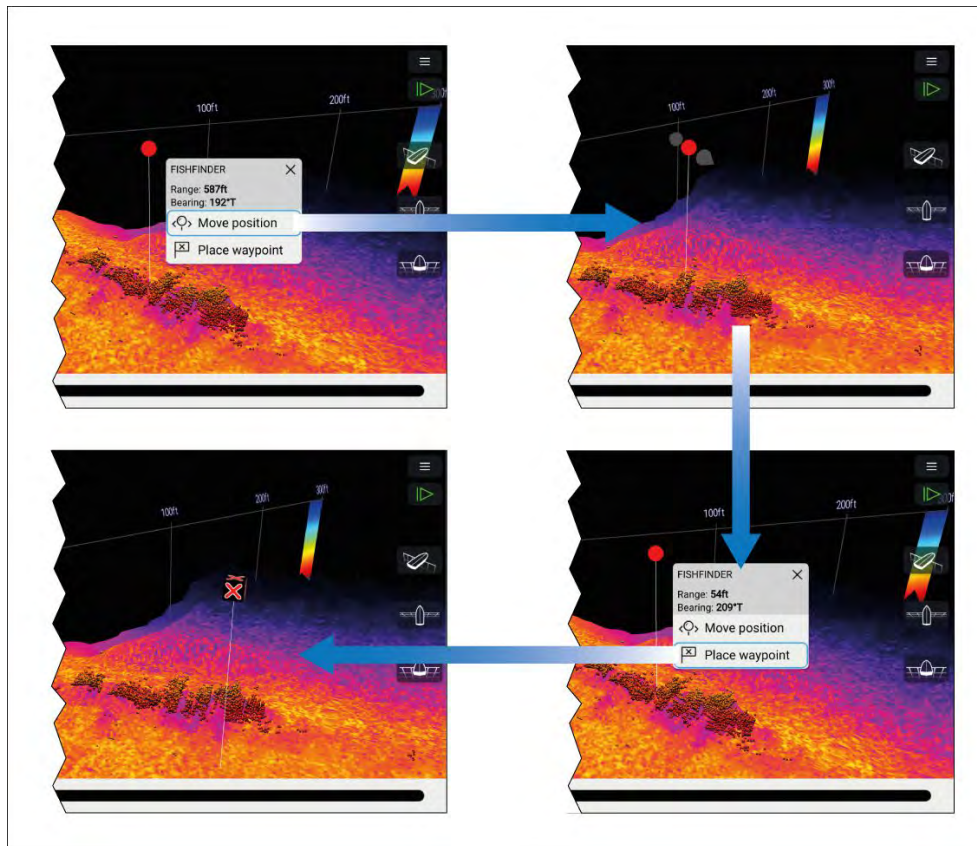

1. Select and hold a location onscreen.
The Waypoint context menu and red waypoint marker is displayed:
2. If required, select [Move position] and then use your finger to drag the waypoint marker to change its position.
3. Select [Place waypoint] to create a waypoint at the marker's location.

21.8 Zoom mode

Zoom mode allows you to magnify a specific section of the water column so that objects or structure appear larger on screen. Zoom mode can zoom to a maximum of 1 foot depth resolution.

Zoom mode is available on down-looking sonar channels, such as DownVision™, CHIRP sonar and traditional sonar channels.

Zoom mode can be activated by:

- using the zoom in pinch-to-zoom gesture (i.e.: moving your fingers apart on the screen.)
- turning the [Uni-controller] (if available) clockwise.
- using the onscreen [Range/Zoom In] icon.

Zoom mode splits the sonar screen to show the zoomed area alongside a preview of the full water column.

When zoom mode is first activated the zoom box position will change dynamically to keep the detected bottom in the zoom area. When the zoom box is moved it will remain in the selected location.

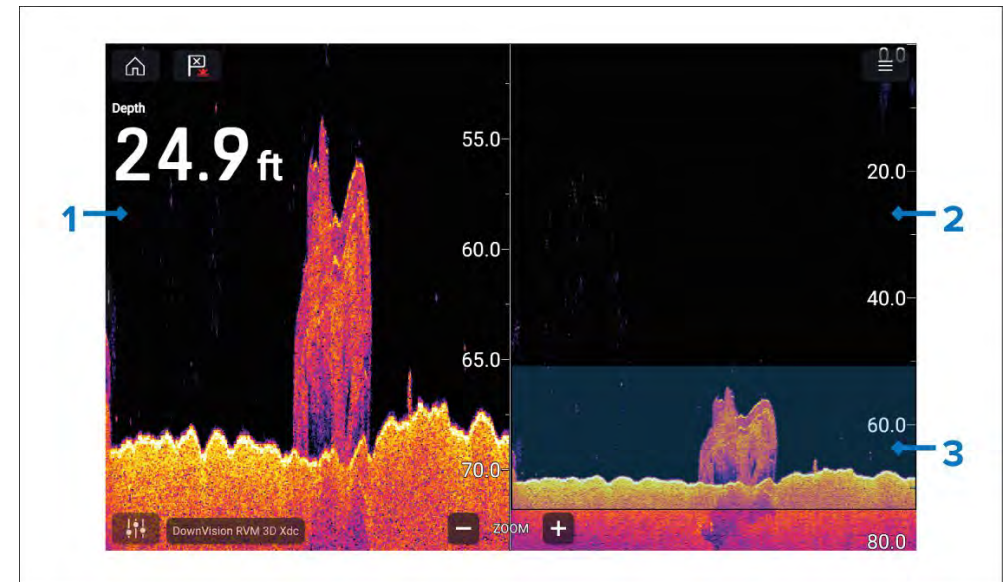

1. **Zoomed area** — The zoomed area is shown on the left side of the screen.
2. **Water column** — The full water column is shown on the right side of the screen.

3. **Zoom box** — The zoom box indicates the section of the water column that is magnified on the left side of the screen.

Zooming

The zoom level can be increased and decreased by:

- performing pinch-to-zoom gestures on the zoomed area
- using onscreen range/zoom icons
- turning the *[Uni-controller]* (if available)

You can also increase and decrease the size of the zoom box using pinch-to-zoom gestures on the water column.

Zooming out fully will deactivate zoom mode.

Changing zoom area

The section of the water column being magnified can be changed by moving the zoom box up and down the water column.

You can move the zoom box by:

- dragging your finger up and down the water column
- using the *[Up]* and *[Down]* buttons on the *[Uni-controller]* (if available).

Zoom mode view

By default, zoom mode uses a 50:50 split for the zoomed area and water column. You can change the zoom view so that the water column appears narrower and the zoomed area is larger.

To change the view mode, use the 50:50 zoom view toggle switch available in the *[Sonar display]* settings menu: *[Menu > Settings > Sonar display > 50:50 zoom view:]*.

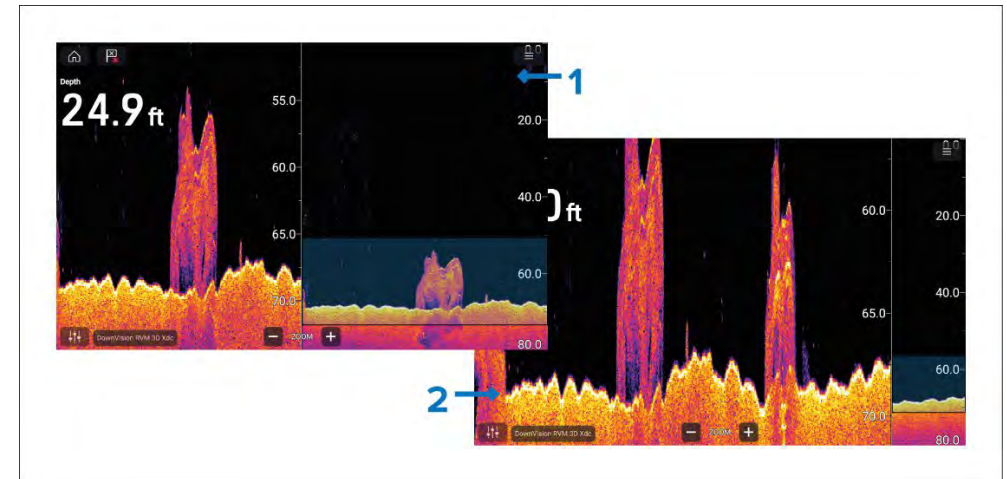

1. 50:50 zoom view enabled (Default option)
2. 50:50 zoom view disabled.

21.9 Fish detection

Fish detection options are available when using a compatible Raymarine® sonar module with a Raymarine® or Airmar conical beam capable sonar transducer.

The fish detection feature is available when using the following conical beam sonar channels

- *[50KHZ]*
- *[200KHZ]*
- *[SONAR]*
- *[CHIRP Low]*
- *[CHIRP High]*
- *[CHIRP Auto]*

Note:

The fish detection feature is not available when using DownVision, SideVision or 3D Vision sonar channels.

The Fish detection feature can be accessed from the fishfinder app menu: *[Menu > Settings > Fish detection]*

Fish detection options include:

- *[Fish detection beep]*— An audible 2-tone beep is sounded when a sonar target is detected that the fish detection algorithm considers to be a fish.
- *[Fish icons]*— A fish icon is placed onscreen over sonar targets that the fish detection algorithm considers to be fish.
- *[Fish depth labels]*— The depths of sonar targets are displayed next to the target that the fish detection algorithm considers to be fish.

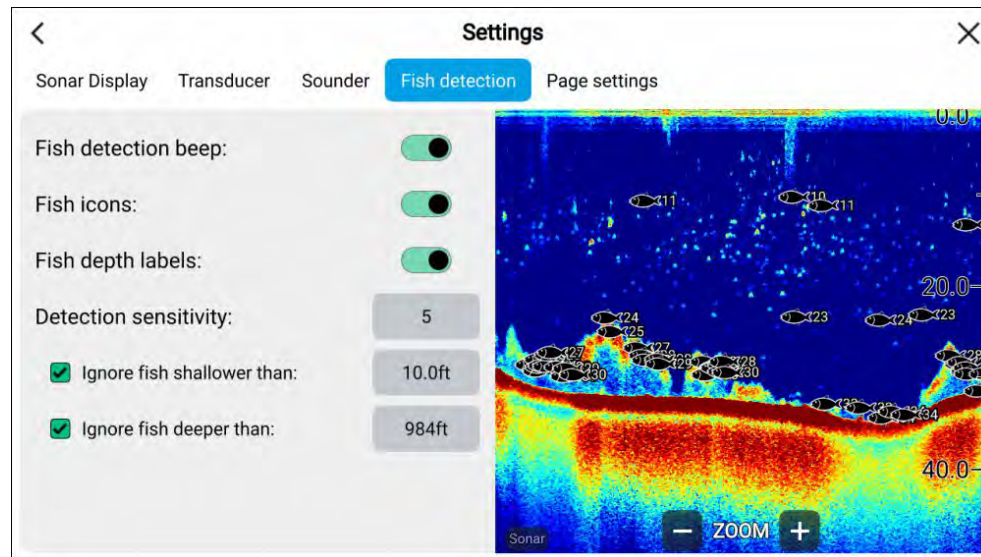

The fish detection feature can be adjusted manually as follows:

- *[Detection sensitivity]*— The detection sensitivity setting determines the size at which sonar targets are considered to be fish. The higher the value, the more sonar targets will be considered to be fish.
- *[Ignore fish shallower than:]* — Specifies the depth at which the fish detection algorithm will be used.
- *[Ignore fish deeper than:]* — Specified the depth at which the fish detection algorithm will stop being used.

Using these options allows you to specify a specific depth band of water where you will be fishing, and also the size of the fish you want to catch.

21.10 Sonar scroll back (history)

You can “scroll back” in the Fishfinder app to view sonar history.

To activate sonar “scroll back”, perform the following:

- **Sonar and DownVision** — Swipe your finger left to right across the sonar screen.
- **SideVision** — Swipe your finger from the bottom to the top of the sonar screen.
- **3D Vision** — Select the onscreen *[Pause]* icon.

When sonar scroll back is active, the sonar *[Scroll back bar]* and *[Unpause]* icons are displayed.

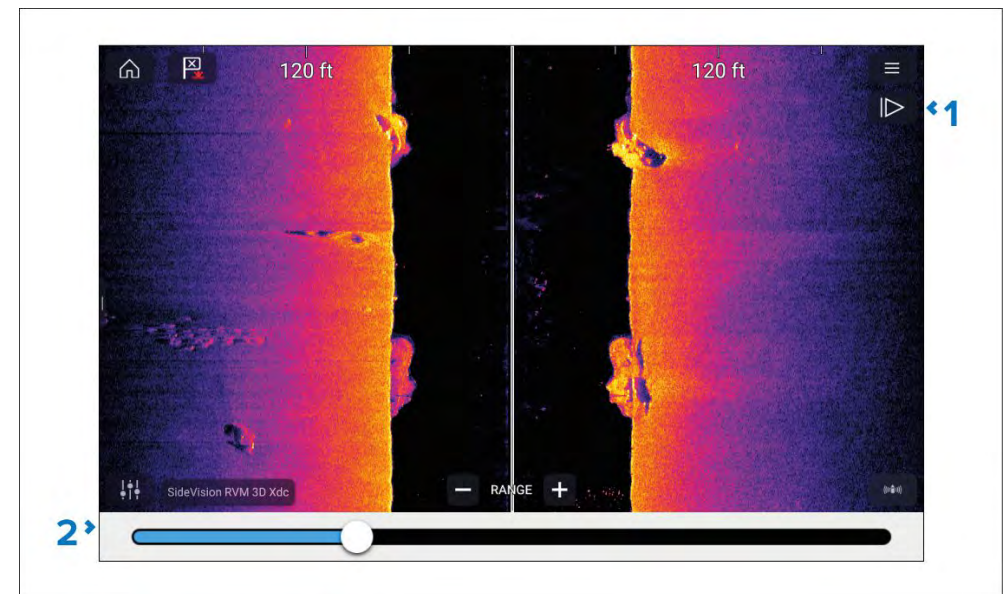

1. *[Unpause]*— Selecting this option resumes live sonar scrolling.
2. *[Scroll back bar]*— Use this to move back and forward through the available sonar history. You can either drag the position indicator right or left or select a specific location on the bar to jump to that position.

In Sonar, DownVision and SideVision channels, subsequent swipes of the screen will also “rewind” the sonar history, and swiping in the opposite direction will “fast forward” the sonar history.



21.11 Sonar sensitivity controls



Optimum performance is usually achieved using the default settings. You can adjust the image using the Sensitivity controls to improve the displayed image. Sensitivity setting adjustment is also applied to the sonar history.



Sensitivity settings can be accessed using the onscreen *[Image adjustment]* icon, or the Adjust sensitivity menu option: *[Menu > Adjust sensitivity]*.

The Sensitivity controls available are dependent upon the transducer and sonar module in use.

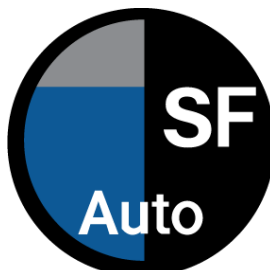
Connector	Description
	<p><i>['G' Gain]</i></p> <p>The control determines the signal strength at which target returns are shown onscreen.</p> <p>The Gain control can be set to <i>[Auto]</i> or <i>[Manual]</i>. Depending on Sonar module, in Auto you can add an offset of up to $\pm 50\%$.</p> <p>A higher value produces more target returns and noise onscreen.</p>
	<p><i>['I' Intensity], or</i> <i>['CG' Color Gain]</i></p> <p>The control sets the lower limit for the color used for the strongest target returns. All target returns above this value are displayed in the strongest color. Those with a weaker value are divided equally between the remaining colors.</p> <p>The control can be set to <i>[Auto]</i> or <i>[Manual]</i>. Depending on Sonar module, in Auto you can add an offset of up to $\pm 50\%$.</p>

Connector	Description
	<p><i>['SF' Surface Filter], or</i> <i>['NF' Noise filter]</i></p> <p>The control determines the amount of noise displayed onscreen by varying the gain throughout the water column.</p> <p>A lower value decreases the depth at which the control is applied.</p> <p>The control can be set to <i>[Auto]</i> or <i>[Manual]</i>.</p>
	<p><i>[All to Auto]</i></p> <p>Sets all Sensitivity settings to <i>[Auto]</i> with 0% offset.</p>

21.12 Frequency tuning

When using an Airmar® CHIRP transducer you can adjust the frequency of the 'Tuned' sonar channels (e.g.: 50 kHz, 200 kHz channels.), using the *[Tune frequency]* control.

The *[Tune frequency]* setting can be accessed using the onscreen controls and from the *[Sounder]* settings menu.

Note:

The *[Tune frequency]* control is available when using CP470, CP570, RVX1000, RVM1600, Axiom Pro RVX and Axiom 2 Pro RVM sonar modules. The *[Tune frequency]* control is not available when using the CP370 sonar module.

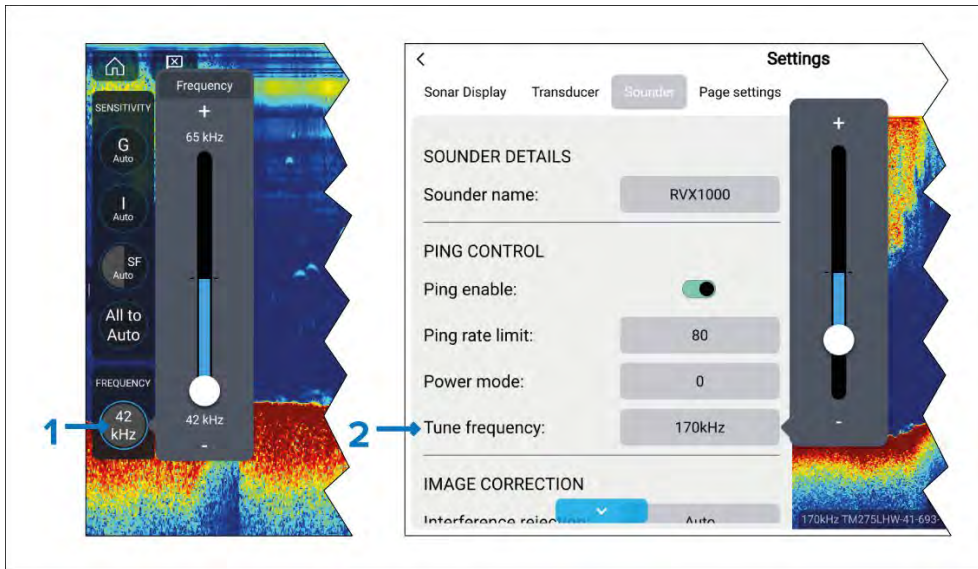

1. Onscreen *[Tune frequency]* control. To adjust the channel frequency using the onscreen controls, select the *[Image adjustment]* icon located on the bottom left of the screen, select the *[Frequency]* control, and then use the slider bar to adjust the channel's frequency.
2. Settings menu *[Tune frequency]* control. To adjust the channel frequency from the settings menu, select *[Menu > Settings > Sounder > Tune frequency]*, select the frequency field and then use the slider bar to adjust the channel's frequency.

The sonar channel name located at the bottom of the Fishfinder app is updated dynamically to reflect the selected frequency.

The frequency range available is determined by the transducer/sonar module in use. The minimum and maximum supported frequencies are displayed on the slider bar.

21.13 Fishfinder settings menu

The table below lists settings applicable to the Fishfinder app and their location within the app Settings menu. The settings available are dependant upon the Sonar module in use.

The following settings menus are provided in the Fishfinder app:

- *[Sonar display]* For details refer to: [p.320 – Sonar display settings menu](#)

- *[Transducer]* For details refer to: [p.324 – Transducer settings menu](#)
- *[Sounder]* For details refer to: [p.324 – Sounder settings menu](#)
- *[Fish detection]* For details refer to: [p.325 – Fish detection settings menu](#)
- *[Page settings]* For details refer to: [p.326 – Page settings menu](#)

21.14 Sonar display settings menu

The *[Sonar display]* settings menu provides options for how the Fishfinder screen is presented and also some channel specific presentation options. Different menu options are available depending on the sonar channel type that is selected.

- 3D Vision options
- SideVision™ options
- DownVision™ options
- CHIRP and traditional options

3D Vision sonar display settings

[3D Vision] channels include the following Sonar display options:

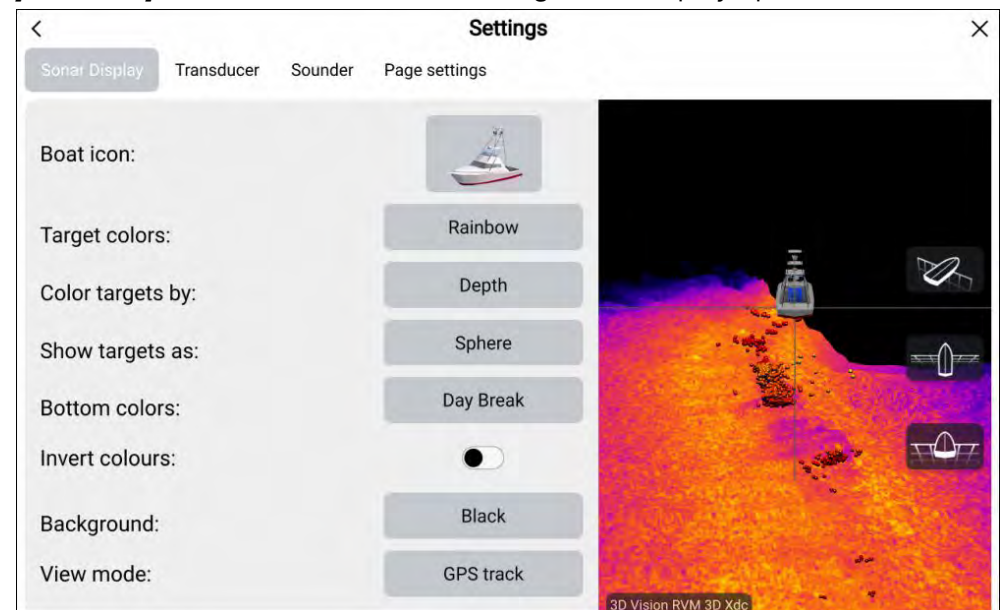

- *[Boat icon:]* — select the icon that is used to represent your vessel's position. There are 4 vessel types to choose from.
- *[Target colors:]* — Select the color palette that you want detected targets to use. The following color palettes are available:
 - *Rainbow*
 - *Burnt Yellow*
 - *Cool Blue*
 - *Lime Green*
 - *Ruby Red*
- *[Color targets by:]* — select to change how targets are colored. You can choose between:
 - *[Depth]*, which colors targets according to their depth; a gradient scale can be shown on the 3D grid to aid depth identification, or
 - *[Intensity]*, which colors targets according to their size; the bigger the target, the darker the color used.
- *[Show targets as:]* — select to change the shape of targets. You can choose between:
 - *Point*, which provides the highest resolution, or:
 - *Sphere*, which provides lower resolution but increases target size for better visibility.
- *[Bottom colors:]* — select to change the color palette used for the bottom and bottom structure. The following colors are available:
 - *Day Break* (RVM transducers only)
 - *Coho Salmon* (RVM transducers only)
 - *Mahi* (RVM transducers only)
 - *Snapper* (RVM transducers only)
 - *Yellowfin* (RVM transducers only)
 - *Copper*
 - *Slate Gray*
 - *Lime Green*
 - *Burnt Yellow*
 - *Cool Blue*
 - *Ruby Red*

- *[Invert colors:]* — in the Fishfinder app, color scales or shading is used to differentiate distances, depths and/or intensity of detected objects. You can invert the colors by selecting this option.
- *[Background:]* — you can change the background color that is used to represent the water. The following colors are available:
 - *Black*
 - *Blue*
 - *White*
 - *Gray*
- *[View mode:]* — select how you want the fishfinder image to appear:
 - *[GPS track]* — the boat icon will remain in the same position and bottom structure and target detail will move in true relation to your vessel's movements.
 - *[Scrolling image]* — the sonar pings at a constant speed and displays a scrolling image behind the boat icon.

SideVision™ sonar display settings

The SideVision™ channel includes the following Sonar display options:

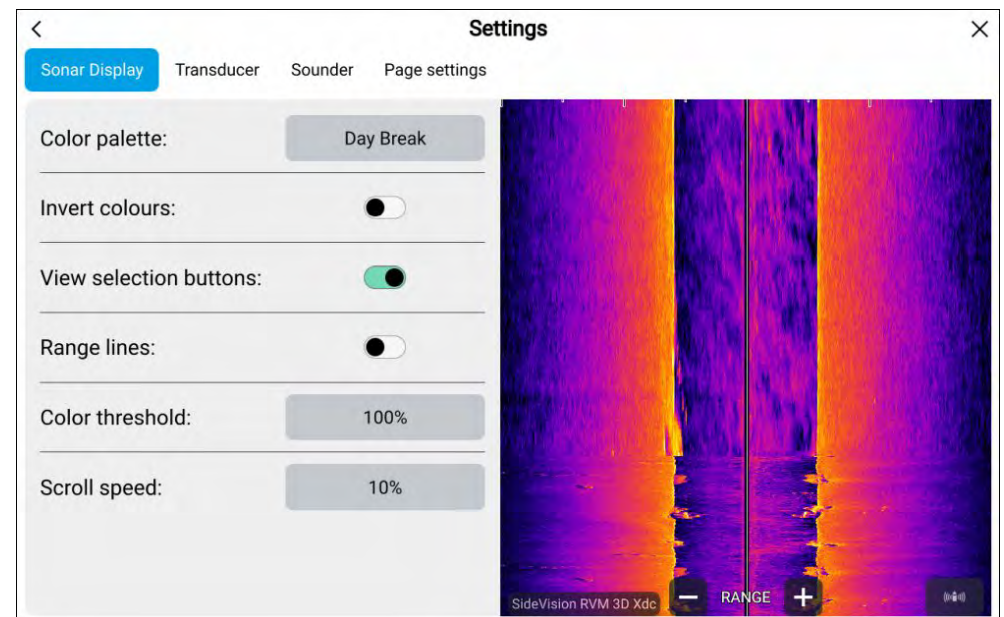

- *[Color palette:]* — select to change the color palette used to identify the bottom, bottom structure and detected targets. The following color palettes are available:
 - *Day Break* (RVM only)
 - *Coho Salmon* (RVM only)
 - *Mahi* (RVM only)
 - *Snapper* (RVM only)
 - *Yellowfin* (RVM only)
 - *Copper*
 - *Slate Gray*
 - *Lime Green*
 - *Burnt Yellow*
 - *Cool Blue*
 - *Ruby Red*
- *[Invert colors:]* — in the Fishfinder app color scales or shading is used to differentiate distances, depths and/or intensity of detected objects. you can invert the colors by selecting this option.
- *[View selection buttons:]* — select to enable and disable onscreen buttons for side selection.
- *[Range lines:]* — select to enable and disable onscreen vertical lines to represent range from your vessel.
- *[Color threshold:]* — select to adjust the color threshold. Color threshold determines the signal strength below which target returns are not shown. A low value results in only the strongest colors or lightest shades being displayed.
- *[Scroll speed:]* — select to adjust the speed the scrolling image.

DownVision™ sonar display settings

The DownVision™ channel includes the following Sonar display options:

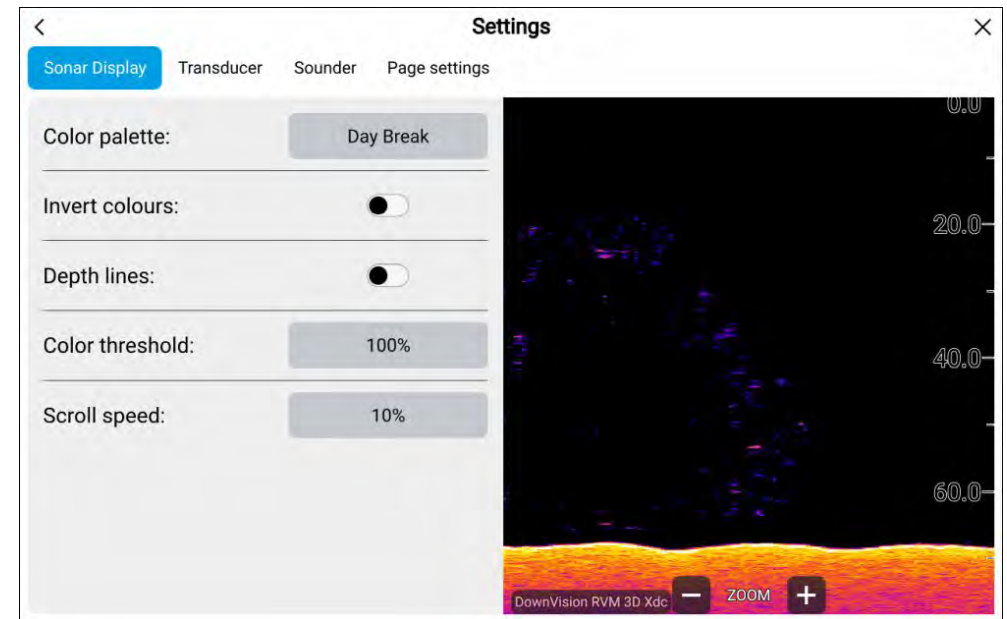

- *[Color palette:]* — select to change the color palette used to identify the bottom, bottom structure and detected targets. The following color palettes are available:
 - *Day Break* (RVM transducers only)
 - *Coho Salmon* (RVM transducers only)
 - *Mahi* (RVM transducers only)
 - *Snapper* (RVM transducers only)
 - *Yellowfin* (RVM transducers only)
 - *Copper*
 - *Slate Gray*
 - *Lime Green*
 - *Burnt Yellow*
 - *Cool Blue*
 - *Ruby Red*

- *[Invert colors:]* — in the Fishfinder app color scales or shading is used to differentiate distances, depths and/or intensity of detected objects. you can invert the colors by selecting this option.
- *[Depth lines:]* — select to enable and disable onscreen horizontal lines to represent water depth.
- *[Color threshold:]* — select to adjust the color threshold. Color threshold determines the signal strength below which target returns are not shown. A low value results in only the strongest colors or lightest shades being displayed.
- *[Scroll speed:]* — select to adjust the speed the scrolling image.

CHIRP and traditional sonar display settings

The CHIRP and traditional sonar channels include the following Sonar display options:

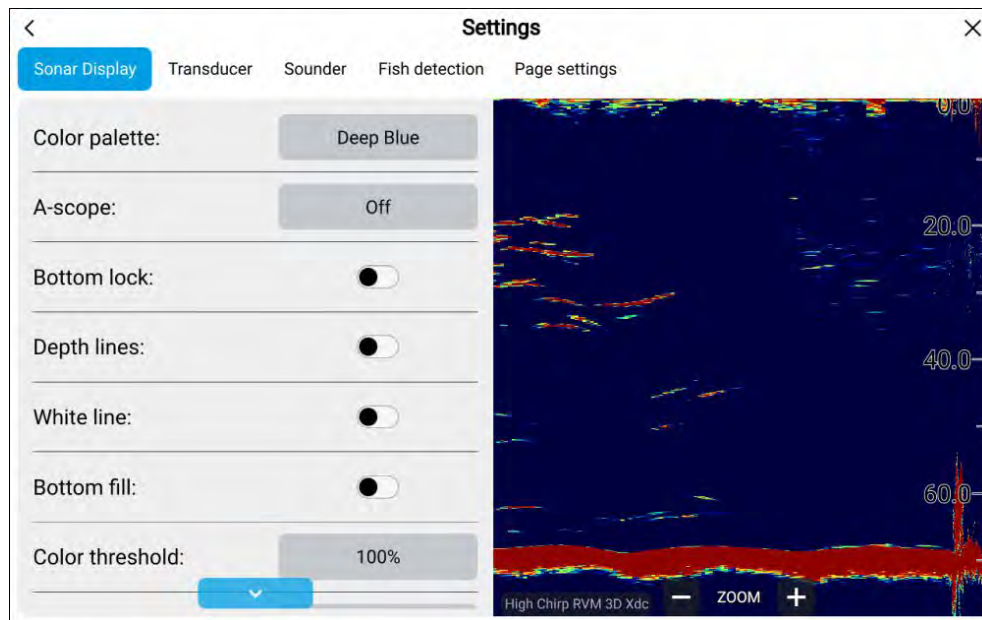

- *[Target colors:]* — Select the color palette that you want detected targets to use. The following color palettes are available:
 - *Deep Blue* (RVM transducers only)
 - *Classic Blue*

- *Classic black*
- *Classic White*
- *Sunburst*
- *Grayscale*
- *Copper*
- *Night vision*

- *[A-scope:]* — select to choose an A scope mode. A-Scope mode provides a splitscreen view that includes the normal scrolling sonar image and a smaller pane which shows a 'live' image of what is directly below your transducer. A scope can be set to *Center*, *Right* or *Cone*.
- *[Bottom lock:]* — select to enable or disable bottom lock. When enabled Bottom Lock flips the range indication readings so that zero is shown as the bottom, this flattens the image of the bottom and makes any objects on or just above it easier to see. This feature is particularly useful for finding fish that feed close to the bottom.

Note: When bottom lock is enabled transducer offset values will be ignored.

- *[Depth lines:]* — select to enable and disable onscreen horizontal lines to represent water depth.
- *[White line:]* — select to enable and disable a solid white line across the detected bottom.
- *[Bottom fill:]* — select to enable and disable solid color fill of the detected bottom and beneath.
- *[Color threshold:]* — select to adjust the color threshold. Color threshold determines the signal strength below which target returns are not shown. A low value results in only the strongest colors or lightest shades being displayed.
- *[Scroll speed:]* — select to adjust the speed the scrolling image.

21.15 Transducer settings menu

Setting	Options
<i>[Transducer]</i> Allows selection of Sonar transducer.	List of available transducers.
<i>[Display depth as]</i> Determines the position from where depth readings are taken from.	<ul style="list-style-type: none"> • Below keel • Below waterline • Below transducer
<i>[Speed transducer]</i> Allows selection of Speed transducer.	List of available transducers.
<i>[Calibrate speed]</i> Allows you to enter an offset between actual measured speed and the current speed displayed by your transducer.	Offset value.
<i>[Enable temperature sensor]</i> Enables and disables the selected transducer's temperature sensor.	<ul style="list-style-type: none"> • On • Off
<i>[Calibrate temp]</i> Allows you to enter an offset between actual measured water temperature and the current temperature displayed by your transducer.	Offset value.

21.16 Sounder settings menu

Setting	Options
<i>[Sounder name]</i> Allows you to rename your sonar module.	Onscreen keyboard.
<i>[Ping enable]</i> Enables and disables transducer ping.	<ul style="list-style-type: none"> • On • Off

Setting	Options
<i>[Ping rate limit]</i> Allows you to restrict the transducer's maximum ping rate to suit current conditions.	<ul style="list-style-type: none"> • 1 to 100
<i>[Power mode]</i> Adjusts the transducer's signal strength. In <i>[Auto]</i> the sonar module will automatically determine the optimal power based on current depth, speed and bottom signal. In <i>[Manual]</i> you can adjust the power to the desired level.	<ul style="list-style-type: none"> • 1 to 100
<i>[Ping rate]</i> Hyper ping should be used at speeds of up to 40 knots in shallower waters (6 metres or less). When the depth reaches 6 metres or above the ping rate will automatically reduce to normal until depth conditions are met.	<ul style="list-style-type: none"> • Normal • Hyper
<i>[Dual channel ping mode]</i> On sonar modules that offer simultaneous dual channel operation, such as the CP570, The ping mode can be changed. <i>[Auto]</i> the Fishfinder app will select the best mode chosen based on range settings. <i>[Independent pings]</i> maximizes ping rate but may introduce interference. <i>[Simultaneous pings]</i> reduced ping rate and reduces chance of interference.	<ul style="list-style-type: none"> • Auto • Independent pings • Simultaneous pings
<i>[Tune frequency]</i> Enables manual tuning of non-CHIRP single frequency sonar channels. The adjustment range is determined by the transducer/sonar module.	<ul style="list-style-type: none"> • Supported frequencies

Setting	Options
<p><i>[AHRS stabilization]</i></p> <p>The AHRS built in to the RealVision™ 3D transducer is used to stabilize the sonar image onscreen based on your vessel's detected movements.</p>	<ul style="list-style-type: none"> • On • Off
<p><i>[Reverse Port/Starboard]</i></p> <p>When a RV100 transducer is hull/step mounted the transducer can be installed with the cable orientated towards either the bow or the stern of the vessel. On installations where the transducer cable is orientated towards the stern of the vessel then the <i>[Reverse Port/Starboard]</i> control must be enabled.</p>	<ul style="list-style-type: none"> • Enabled • Disabled
<p><i>[Interference rejection]</i></p> <p>Removes interference caused by other transducers on your vessel or from vessels equipped with transducers close by.</p>	<ul style="list-style-type: none"> • Auto • Low • Medium • High • Off
<p><i>[2nd echo rejection]</i></p> <p>The control helps to remove false target returns or false bottom that can be caused by signal reflection.</p>	<ul style="list-style-type: none"> • Off • Low • High

Setting	Options
<p><i>[Dual-channel ping mode.]</i></p> <p>On Axiom® Pro and Axiom® 2 Pro displays, when using multiple transducers at the same time you can balance the ping rate vs interference between the two transducers using the <i>[Dual-channel ping mode.]</i> option</p> <p>By default Independent ping is selected, if you experience interference then you can 'lock' the transducers to ping at the same rate.</p> <p>Locking to the transducer with the fastest ping rate should give the best results.</p>	<ul style="list-style-type: none"> • Independent ping • Lock to RV 3D Xdcr • Lock to <transducer name>
<p><i>[Reset sounder]</i></p> <p>Resets the sonar module to factory default settings.</p>	<ul style="list-style-type: none"> • Yes • No
<p><i>[Reset trip]</i></p> <p>In installations that include a speed transducer connected via the sonar module a trip log is automatically recorded. Selecting this option resets the sonar module's trip log.</p>	<ul style="list-style-type: none"> • Yes • No

21.17 Fish detection settings menu

Note:

The fish detection tab is only available when viewing a high CHIRP sonar channel.

Setting	Options
<p><i>[Fish detection beep:]</i></p> <p>Enables and disables audible beep when a target is detected that is considered to be a fish.</p>	<ul style="list-style-type: none"> • On • Off (default)
<p><i>[Fish icons:]</i></p> <p>Enables and disables display of a fish icon over targets considered to be fish.</p>	<ul style="list-style-type: none"> • On • Off (default)
<p><i>[Fish depth labels:]</i></p> <p>Enables and disables display of depth labels next to targets considered to be fish.</p>	<ul style="list-style-type: none"> • On • Off (default)
<p><i>[Detection sensitivity:]</i></p> <p>Determines how sensitive the fish detection algorithm is.</p> <p>The higher the value, the more target returns will be considered to be fish.</p>	<p>Values from 0 to 10 (8 (default))</p>
<p><i>[Ignore fish shallower than:]</i></p> <p>Targets returns found in water shallower than the specified depth will not be considered to be fish.</p>	<p>0 ft to 1000 ft (3.3 ft (default)) or equivalent units.</p>
<div style="border: 1px solid black; padding: 5px;"> <p>Note:</p> <p>The shallow limit cannot be greater than the deep limit.</p> </div>	
<p><i>[Ignore fish deeper than:]</i></p> <p>Targets returns found in water deeper than the specified depth will not be considered to be fish.</p>	<p>0 ft to 1000 ft (984 ft (default)) or equivalent units.</p>
<div style="border: 1px solid black; padding: 5px;"> <p>Note:</p> <p>The deep limit cannot be less than the shallow limit.</p> </div>	

21.18 Page settings menu

The page settings menu allows you to configure data overlays and, when applicable, adjust the position of the split on pages containing multiple apps.

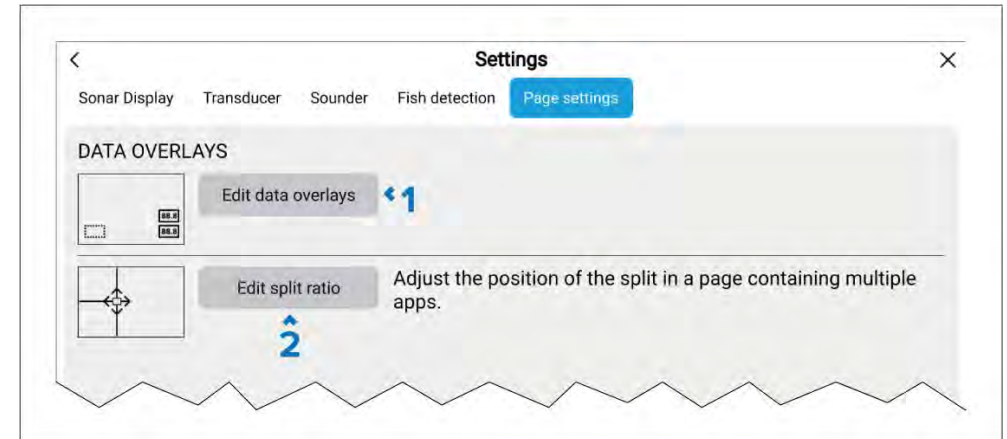

1. *[Edit data overlays]* Fore details refer to: [p.49 — Data overlays](#)
2. *[Edit split ratio]* Fore details refer to: [p.96 — Editing the splitscreen ratio](#)

CHAPTER 22: RADAR APP

CHAPTER CONTENTS

- [22.1 Radar app overview — page 328](#)
- [22.2 Compatible Radar scanners — page 331](#)
- [22.3 Radar feature comparison — page 332](#)
- [22.4 Opening the Radar app — page 335](#)
- [22.5 Set up and configuration — page 336](#)
- [22.6 Radar modes — page 338](#)
- [22.7 Range rings — page 339](#)
- [22.8 Range and bearing — page 340](#)
- [22.9 AIS targets — page 341](#)
- [22.10 Radar targets — page 344](#)
- [22.11 Target data reference mode — page 349](#)
- [22.12 Dangerous targets alarm — page 349](#)
- [22.13 Guard zone alarms — page 350](#)
- [22.14 Doppler Radar overview — page 350](#)
- [22.15 Blank sectors — page 352](#)
- [22.16 Radar sensitivity controls — page 353](#)
- [22.17 Radar settings menus — page 353](#)

22.1 Radar app overview

The Radar app displays a visualization of the echoes received from a connected Radar scanner. The Radar app is a navigation aid used to help enhance collision and situational awareness by enabling target's distance and speed to be tracked in relation to your vessel.

Up to 2 Radar scanners can be connected at the same time. However, only 1 Radar in a system can be a Quantum™ Radar.

For each instance of the Radar app you can select which Radar scanner you want to use, the Radar scanner selection will persist over a power cycle.

The Radar app can be displayed in both Fullscreen and splitscreen app pages. App pages may consist of up to 2 instances of the Radar app.

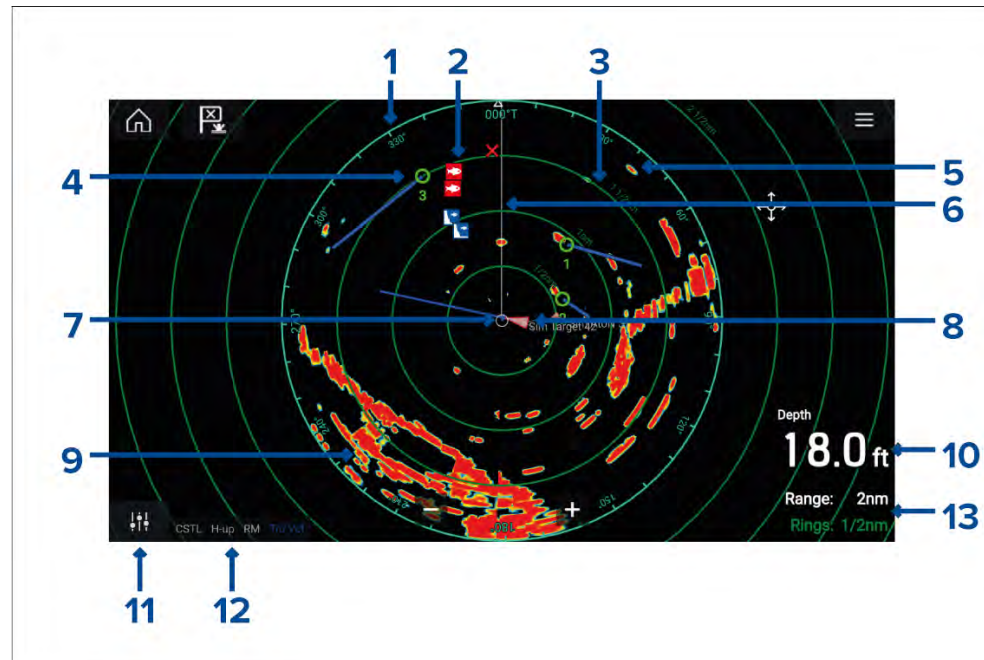





1. **Azimuth ring** — used to provide indication of bearing.
2. **Waypoint symbols** — waypoint symbols can be displayed in the Radar app.
3. **Range rings** — evenly spaced concentric circles help determine distances in the Radar app.
4. **Tracked radar target** — symbols with vector lines are used to represent tracked radar targets.





5. **Radar return** — possible target e.g.: vessel.
6. **SHM (Ship heading marker)** — points in the direction of travel on the azimuth ring.
7. **Own vessel position** — indicates own vessel position in relation to the radar returns.
8. **AIS target** — symbols with vector lines are used to represent AIS targets.
9. **Radar return** — land mass.
10. **Data overlay** — by default depth is displayed.
11. **Sensitivity controls** — access the Radar app's sensitivity controls.
12. **Radar mode and status** — identifies the Radar mode, orientation and motion mode.
13. **Range and rings** — shows the current Radar app range and spacing between range rings.

The Radar app allows you to configure alarms which are triggered when a target or object conflicts with the *[Dangerous targets]* or *[Guard Zone]* alarm settings.

The Range rings, azimuth ring and VRM/EBLs can be used to identify a targets distance and heading in relation to your vessel.

Radar app controls

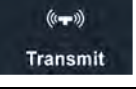
Icon	Description	Action
	Home icon	Takes you to the Homescreen
	Waypoint / MOB	Place waypoint / activate Man Overboard (MOB) alarm
	Pilot icon	Opens and closes the Pilot Sidebar
	Menu icon	Opens the App menu

Icon	Description	Action
	Image adjustment	Displays onscreen sensitivity / image adjustment controls
	Power Off	Powers down the current Radar scanner
	Power On	Powers up the selected Radar scanner
	Transmit	Start Radar transmission
	Range In	Decreases the distance displayed onscreen (minimum range: 1/16nm).
	Range Out	Increases the distance displayed onscreen (up to your Radar scanner's maximum range).

Radar app context menu

Context menus provide context sensitive menu options.



- Context menus are accessed in the Radar app by selecting a location or target.
- The context menu provides Latitude, longitude, range and bearing details for the selected location or object.
- The context menu provides quick access to relevant settings or features.
- Select *[More options]* to display further options.

AIS target context menu

When an AIS target is selected in the Radar app the AIS target context menu is displayed.

The AIS target context menu includes the following information and settings:

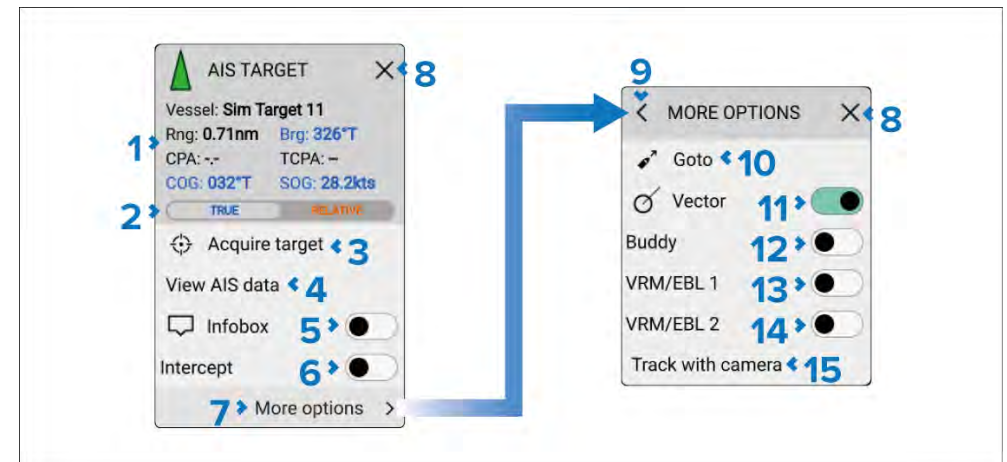

1. AIS data — The following AIS data is displayed:

- Vessel name.
- Range from your vessel.
- Bearing from your vessel.

- CPA (Closest Point of Approach) and TCPA (Time to Closest Point of Approach).
 - Course (COG or relative course).
 - Speed (SOG or relative speed).
2. *[True]/[Relative]*— Switches Bearing, Course and Speed data between *[True]* and *[Relative]* for the selected target.
 3. *[Acquire target]*— Acquire the AIS target as a Radar target.
 4. *[View AIS data]*— View full page AIS data report.
 5. *[Infobox]*— Enable and disable onscreen display of AIS data next to the target symbol.
 6. *[Intercept]*— Enable and disable target interception.
 7. *[More options]*— View further options.
 8. *[X]*(close) — Close the context menu.
 9. *[<]*(back arrow) — Go back to first context menu.
 10. *[Goto]*— Perform a goto.
 11. *[Vector]*— Enable and disable target vectors.
 12. *[Buddy]*— Add or remove target from Buddy list.
 13. *[VRM/EBL 1]*— Enable and disable VRM/EBL 1.
 14. *[VRM/EBL 2]*— Enable and disable VRM/EBL 2.
 15. *[Track with camera]*— Track the target with a compatible PTZ camera.

First responder

When the display is configured using the First responder activity the following additional data and options will be available:

- AIS data — Boat type, Status, Intcpt (Intercept time).
- *[Designate TOI]*.
- *[Send message]*.

Radar target context menu

When an acquired Radar target is selected in the Radar app the Radar target context menu is displayed.

The Radar target context menu includes the following information and settings:

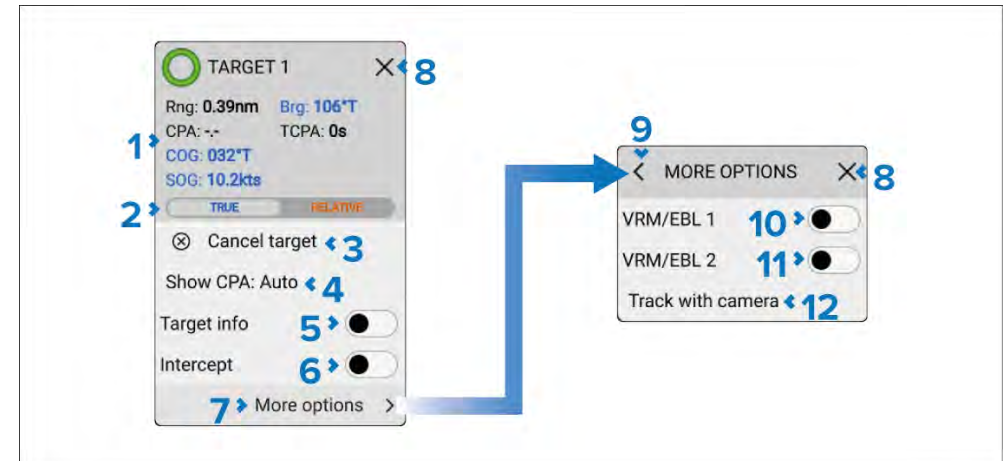

1. Target data — The following data is displayed:
 - Range from your vessel.
 - Bearing from your vessel.
 - CPA (Closest Point of Approach) and TCPA (Time to Closest Point of Approach).
 - Course (COG or relative course).
 - Speed (SOG or relative speed).
2. *[True]/[Relative]*— Switches Bearing, Course and Speed data between *[True]* and *[Relative]* for the selected target.
3. *[Cancel target]*— Delete the selected Radar target.
4. *[Show CPA:]* —
5. *[Target info]*— Enable and disable onscreen display of data next to the target symbol.
6. *[Intercept]*— Enable and disable target interception.
7. *[More options]*— View further options.
8. *[X]*(close) — Close the context menu.
9. *[<]*(back arrow) — Go back to first context menu.
10. *[VRM/EBL 1]*— Enable and disable VRM/EBL 1.
11. *[VRM/EBL 2]*— Enable and disable VRM/EBL 2.
12. *[Track with camera]*— Track the target with a compatible PTZ camera.

First responder

When the display is configured using the First responder activity the following additional data and options will be available:

- AIS data — Boat type, Status, Intcpt (Intercept time).
- *[Designate TOI]*.
- *[Send message]*.

Moving (dragging) the context menu

In the Radar app the context menu can be moved.

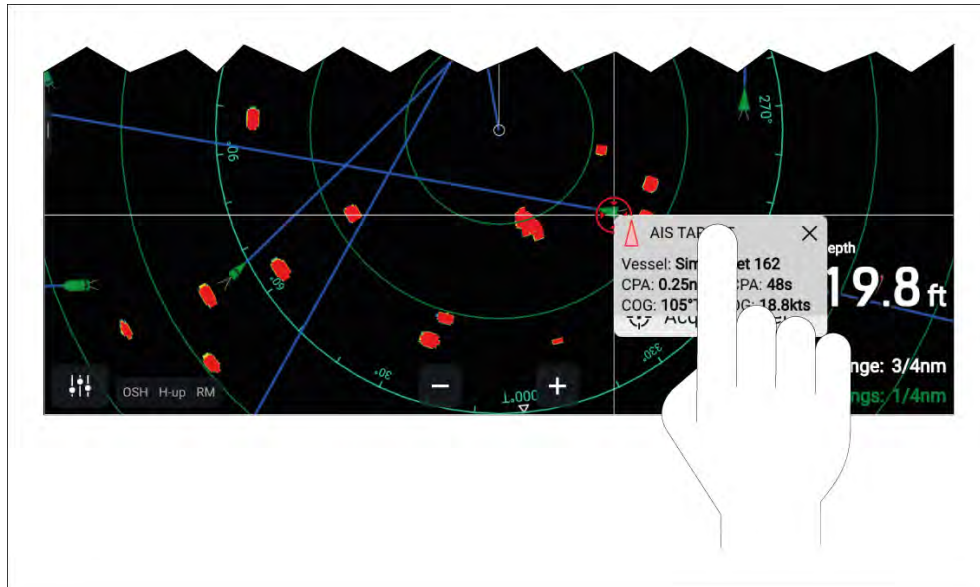

1. In the Radar app, tap the screen to display the context menu.
2. Tap and hold on the context menu header.
3. Drag your finger to a new location or object.
4. When you remove your finger, the context menu will remain in position.

As the context menu is moved across the screen, the context menu details displayed in the top left corner of the context menu are updated to reflect the new location or current target tracked under the cursor position.

Camera tracking

When connected to a compatible Pan and Tilt Thermal camera you can track targets or point your camera at a specific target or area.

2 options are available for camera tracking:

- *[Point camera here]*— Points the camera at a specific point onscreen, the camera will remain pointed at this area regardless of your own vessel's course.
- *[Track with camera]*— Tracks a selected target regardless of your own vessel's or target's course.

Camera tracking options are available from the Context menu in the Chart and Radar apps: *[Context menu > more options > Point camera here]*, or *[Context menu > more options > Track with camera]*.

Automatic tracking

You can use the Camera app settings to configure automatic tracking for AIS, Radar and MoB targets: *[Camera app > Menu > Settings > Camera motion > AUTO TRACKING]*

22.2 Compatible Radar scanners

- Cyclone — Solid state open array
- Magnum — Open array
- Quantum™ 2 Doppler — Radome
- Quantum™ — Radome
- SuperHD™ — Open array
- HD — Open array
- HD — Radome
- Digital — Radome (non-HD)

22.3 Radar feature comparison

The features and settings available in the Radar app are dependent on your connected Radar scanner type.

Sensitivity controls

Feature/setting	Radar type
Gain	<ul style="list-style-type: none"> All
Color Gain	<ul style="list-style-type: none"> Cyclone — Solid state open array Magnum — Open array Quantum™ 2 Doppler — Radome Quantum™ — Radome SuperHD™ — Open array HD — Open array HD — Radome
Rain	<ul style="list-style-type: none"> All
Sea Clutter	<ul style="list-style-type: none"> All
FTC (Fast Time Constant)	<ul style="list-style-type: none"> Digital — Radome (non-HD)
Power Boost	<ul style="list-style-type: none"> Magnum — Open array SuperHD™ — Open array
Antenna Boost	<ul style="list-style-type: none"> Magnum — Open array SuperHD™ — Open array
Beam sharpening	<ul style="list-style-type: none"> Cyclone — Solid state open array
Near target enhancement	<ul style="list-style-type: none"> Cyclone — Solid state open array

Radar modes

Feature/setting	Radar type
Buoy	<ul style="list-style-type: none"> Magnum — Open array SuperHD™ — Open array HD — Open array HD — Radome
Harbor	<ul style="list-style-type: none"> Cyclone — Solid state open array Magnum — Open array Quantum™ 2 Doppler — Radome Quantum™ — Radome SuperHD™ — Open array HD — Open array HD — Radome
Coastal	<ul style="list-style-type: none"> Magnum — Open array Quantum™ 2 Doppler — Radome Quantum™ — Radome SuperHD™ — Open array HD — Open array HD — Radome
Offshore	<ul style="list-style-type: none"> Cyclone — Solid state open array Magnum — Open array Quantum™ 2 Doppler — Radome Quantum™ — Radome SuperHD™ — Open array HD — Open array HD — Radome

Feature/setting	Radar type
Bird	<ul style="list-style-type: none"> • Cyclone — Solid state open array • Magnum — Open array • SuperHD™ — Open array • HD — Open array • HD — Radome
Weather	<ul style="list-style-type: none"> • Quantum™ 2 Doppler — Radome • Quantum™ — Radome

Radar features

Feature/setting	Radar type
Sector blanking	<ul style="list-style-type: none"> • Cyclone — Solid state open array • Magnum — Open array • Quantum™ 2 Doppler — Radome (Radar software version 2.46 and above)
True trails	<ul style="list-style-type: none"> • Cyclone — Solid state open array • Magnum — Open array • Quantum™ 2 Doppler — Radome • Quantum™ — Radome
Note: Requires heading sensor.	
Doppler	<ul style="list-style-type: none"> • Cyclone — Solid state open array • Quantum™ 2 Doppler — Radome
Dual Range	<ul style="list-style-type: none"> • Cyclone — Solid state open array • Magnum — Open array • SuperHD™ — Open array • HD — Open array • HD — Radome
RangeFusion™	<ul style="list-style-type: none"> • Cyclone — Solid state open array
Interference Rejection	<ul style="list-style-type: none"> • All

Feature/setting	Radar type
Interference Rejection Level	<ul style="list-style-type: none"> • Cyclone — Solid state open array • Quantum™ 2 Doppler — Radome • Quantum™ — Radome • Digital — Radome (non-HD)
Expanded Returns	<ul style="list-style-type: none"> • All
Expansion Level	<ul style="list-style-type: none"> • Digital — Radome (non-HD)
Guard Zones	<ul style="list-style-type: none"> • All = 2
Guard Zone Sensitivity	<ul style="list-style-type: none"> • All
Maximum Tracked Radar Targets	<ul style="list-style-type: none"> • Cyclone Software V1.25 or later — Solid state open array = 100 • Cyclone — Solid state open array = 50 • Magnum — Open array = 25 • Quantum™ 2 Doppler — Radome = 25 • Quantum™ — Radome = 10 • SuperHD™ — Open array = 25 • HD — Open array = 25 • HD — Radome = 25 • Digital — Radome (non-HD) = 10
Auto acquisition of Radar targets	<ul style="list-style-type: none"> • Cyclone — Solid state open array • Magnum — Open array • Quantum™ 2 Doppler — Radome
Tuning	<ul style="list-style-type: none"> • Magnum — Open array • SuperHD™ — Open array • HD — Open array • HD — Radome

Feature/setting	Radar type
Transmit Frequency	<ul style="list-style-type: none"> • Cyclone — Solid state open array • Quantum™ 2 Doppler — Radome • Quantum™ — Radome
Scanner Rotation Speed	<ul style="list-style-type: none"> • Cyclone — Solid state open array = 12 RPM, 24 RPM, 36 RPM, 48 RPM, 60 RPM and Auto • Magnum — Open array = 24 RPM and Auto (48 RPM) • Quantum™ 2 Doppler — Radome = 24 RPM • Quantum™ — Radome = 24 RPM • SuperHD™ — Open array = 24 RPM and Auto (48 RPM) • HD — Open array = 24 RPM and Auto (48 RPM) • HD — Radome = 24 RPM and Auto (48 RPM) • Digital — Radome (non-HD) = 24 RPM
Sea Clutter Curve	<ul style="list-style-type: none"> • All
Parking Offset	<ul style="list-style-type: none"> • Magnum — Open array • SuperHD™ — Open array • HD — Open array
Antenna Size selection	<ul style="list-style-type: none"> • Magnum — Open array • SuperHD™ — Open array = 4ft / 6ft • HD — Open array = 4ft / 6ft

Note:

Antenna size selection (i.e.: 3ft, 4ft or 6ft) for Cyclone radars is automatically detected and cannot be selected manually.

Feature/setting	Radar type
Timed Transmit	<ul style="list-style-type: none"> • All
Bearing Alignment	<ul style="list-style-type: none"> • All
MBS (Main Bang Suppression) Off	<ul style="list-style-type: none"> • All
Tuning Preset	<ul style="list-style-type: none"> • Magnum — Open array • SuperHD™ — Open array • HD — Open array • HD — Radome • Digital — Radome (non-HD)
STC (Sensitivity Time Control) Preset	<ul style="list-style-type: none"> • Digital — Radome (non-HD)
VRM/EBL (Variable Range Markers/Electronic Bearing Line)	<ul style="list-style-type: none"> • All
Display Timing	<ul style="list-style-type: none"> • SuperHD™ — Open array = 0–767m • HD — Open array = 0–767m • HD — Radome = 0–767m • Digital — Radome (non-HD) = 0–153.6m

Feature/setting	Radar type
Maximum Range	<ul style="list-style-type: none"> • Cyclone — Solid state open array = 96nm • Magnum — Open array = 4kW = 72nm, 6kW = 96nm • Quantum™ 2 Doppler — Radome = 24nm • Quantum™ — Radome = 24nm • SuperHD™ — Open array = 72nm • HD — Open array = 72nm • HD — Radome = 48nm • Digital — Radome (non-HD) = 48nm
Colors	<ul style="list-style-type: none"> • Cyclone — Solid state open array = 256 • Magnum — Open array = 256 • Quantum™ 2 Doppler — Radome = 256 • Quantum™ — Radome = 256 • SuperHD™ — Open array = 256 • HD — Open array = 256 • HD — Radome = 256 • Digital — Radome (non-HD) = 8

22.4 Opening the Radar app

The Radar app is opened by selecting a page icon from the Homescreen that includes the Radar app.

Pre-requisites:

1. Ensure your Radar scanner is compatible, check the latest details available on the Raymarine website, if in doubt please contact an authorized Raymarine dealer for advice.
2. Ensure you have installed your Radar scanner in accordance with the documentation that was supplied with your Radar.

The Radar app will open in 1 of 3 states:

Off/Not Connected

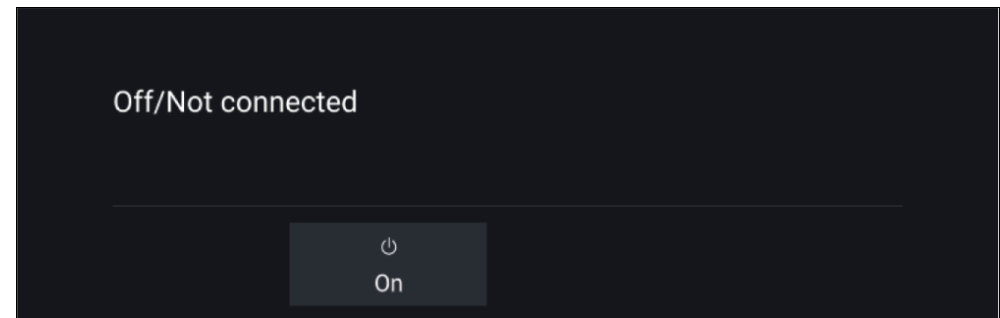

If the **'Off/Not Connected'** message is displayed then:

- your Radar scanner may be powered down, or
- your MFD cannot establish a connection with your Radar scanner

Select *[On]* to power up your Radar. If the **'Radar not found'** message is displayed then a connection could not be established, ensure that network and power connections to your Radar and MFD are correct and free from damage and then power cycle your system. If the Radar scanner can still not be found refer to your Radar's installation documentation for further troubleshooting information.

Off

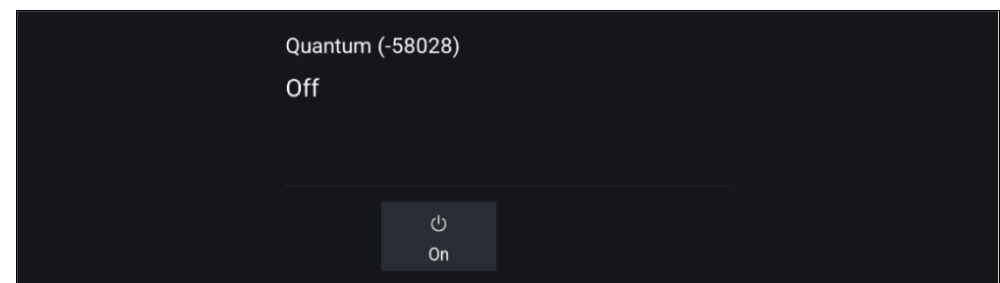

If the **'Off'** message is displayed then your Wi-Fi connected Radar scanner is paired but powered off, select *[On]* to power up your Radar

Standby (Not transmitting)

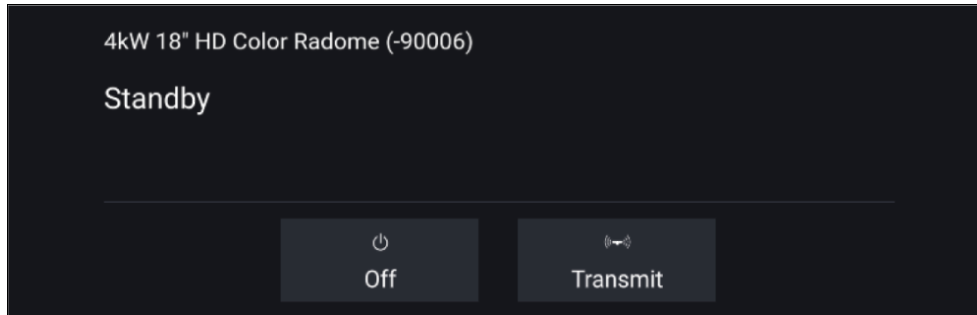

If the **'Standby'** message is displayed then select *[Transmit]* to begin transmitting.

Transmitting

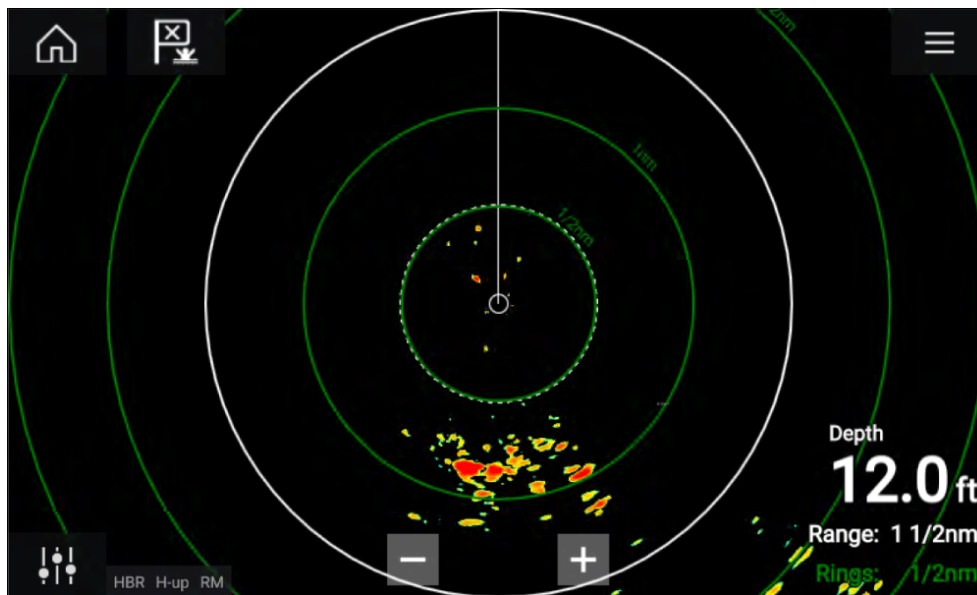

If your Radar scanner is connected, powered up and transmitting then the Radar image is displayed and echoes/targets are displayed onscreen.

Putting the radar into standby

With your selected radar displayed onscreen:

1. Select *[Transmit]* from the main menu.
The radar scanner will stop transmitting and is put into standby mode.

Powering down your radar scanner

With your radar scanner in standby mode:

1. Select the *[Off]* icon.
2. Select *[Yes]* to confirm power down.

The radar scanner will still consume a small amount of power whilst it is powered off, this is to ensure the radar can be powered back up quickly.

22.5 Set up and configuration

Selecting a Radar scanner

On systems with 2 Radar scanners, you can select which Radar scanner is used in each instance of the Radar app.

1. Select the *[Settings]* ("cogs") icon from the Radar app menu.

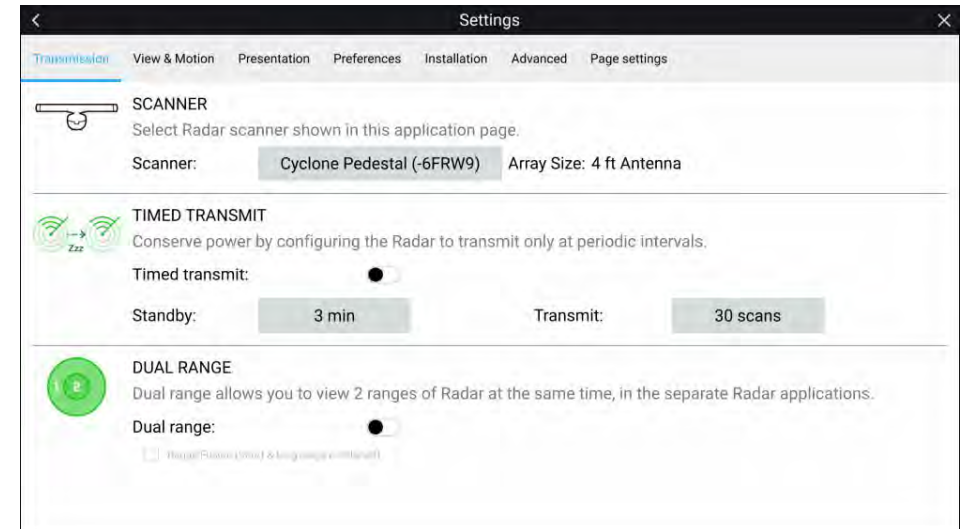

2. Select the *[Scanner:]* box on the *[Transmission]* tab.
A list of available Radar scanners is displayed.
3. Select the Radar scanner that you want to associate with the current instance of the Radar app.

4. Close the *[Settings]* page.

The current instance of the Radar app will change to display the selected Radar scanner. Radar scanner selection shall persist over a power cycle. Alternatively, with the Radar powered off or in Standby, you can select switch Radar scanner by selecting *[Change scanner]*.



Dual range

Cyclone, Magnum, HD and SuperHD™ radar scanners are capable of *[Dual range]*. Dual range enables you to view 2 ranges (i.e. short range and long range) simultaneously.

To view both ranges you will need to configure a splitscreen, dual radar, app page that displays the same Radar scanner in each window. You can then enable *[Dual Range]* mode and set the *[Channel]* for each window from the *[Transmission]* tab: *[Menu > Settings > Transmission]*.

Note:

The following dual range limitations do not apply to Cyclone radar scanners.

Dual range limitations:

- Dual range cannot be enabled when radar targets are being tracked (clear the target list and try again).
- When dual range is enabled manual and automatic radar target acquisition is disabled
- In dual range the maximum rotation speed is 24rpm.
- When using a Magnum or SuperHD™ open array radar scanner *[Antenna boost]* and *[Power boost]* controls are only applied to the long range channel.
- Open array radar scanners running version 1.xx or 2.xx software will have the short range channel's maximum range restricted to 3 nm.

- When dual range is enabled on a radar scanner running version 1.xx or 2.xx software the *[Expansion]* control will be disabled.

RangeFusion™

When using a Cyclone radar scanner the RangeFusion™ feature is available in the dual range settings. Range fusion enables the short range and long range to be displayed simultaneously in a merged view in the same radar app.

When using RangeFusion the short range channel can be viewed separately. The large range channel is always merged with the short range channel.

Timed Radar transmission

To help conserve power you can configure your Radar to only transmit periodically.

From the Radar menu:

1. Select the *[Settings]* ("cogs") icon.
The settings page is displayed.
2. Switch on *[Time Transmit:]* using the toggle switch.
3. Select *[Standby:]* and choose a time interval.
4. Select *[Transmit:]* and choose the number of rotations you want the Radar to perform.

The Radar will transmit for the specified number of rotations and then will switch to Standby for the specified time interval, the sequence will repeat until Timed Transmit is switched off.

The Timed transmit will revert to Off after a power cycle.

Setting open array antenna size

When connected to a HD, SuperHD or Magnum open array radar scanner you can configure the *[Antenna size]*. Setting the antenna size can help when setting a *[Parking offset]*.

Note:

Antenna size selection (i.e.: 3ft, 4ft or 6ft) for Cyclone radars is automatically detected and cannot be selected manually.

From the Radar app:

1. Select *[Menu > Settings > Transmission]*.

2. Select the correct size for your Radar's antenna from the *[Antenna size]* option.

Check and adjust bearing alignment

The Radar bearing alignment ensures that Radar objects appear at the correct bearing relative to your boat's bow. You should check the bearing alignment for any new installation.

Example misaligned Radar

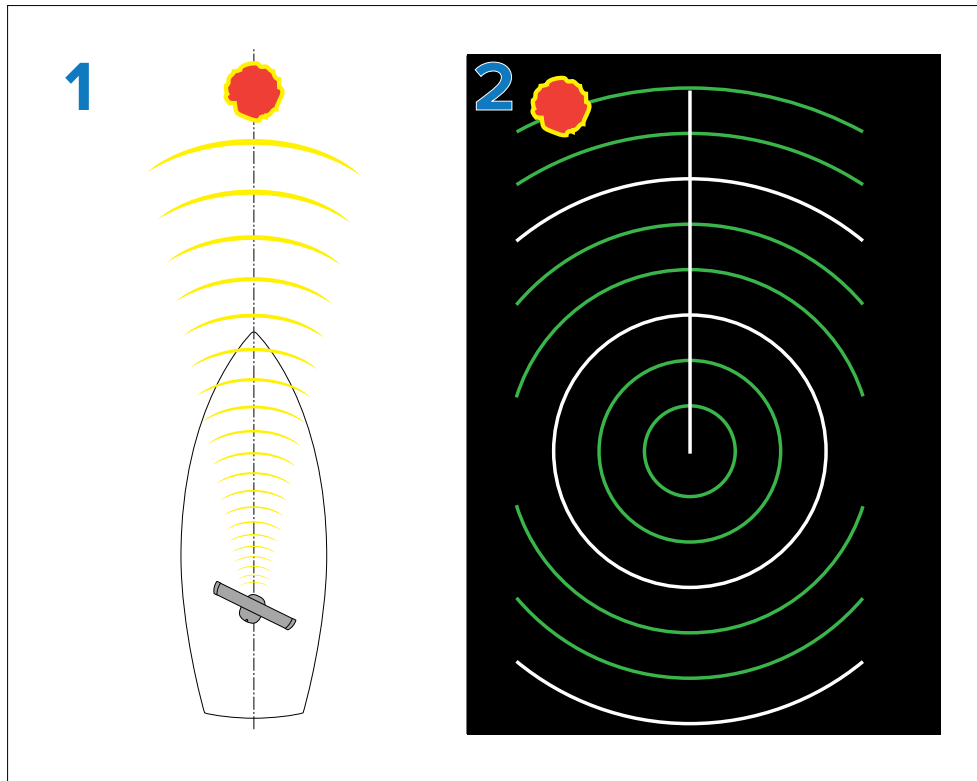

1. Target object (such as a buoy) dead ahead.
2. Target displayed on the Radar display is not aligned with the Ship's Heading Marker (SHM). Bearing alignment is required.

Checking alignment

Align the bow with a stationary object between 0.25 and 2 NM away.

Reduce the gain to make the target as small as possible on the screen.

Note the position of the object on the Radar screen. If the target is not under the ship's heading marker (SHM), then bearing alignment adjustment is required.

Adjusting alignment

Adjust the *[Bearing alignment]* setting until the target object appears under the SHM.

The *[Bearing alignment]* setting can be accessed from the *[Installation]* tab: *[Menu > Installation > Bearing alignment]*.

Note:

Heading (HDG) is displayed in the Radar application. Please be aware that bearing alignment refers to the **relative** bearing of **targets** to the vessel's bow using visual checks / traditional means.

22.6 Radar modes

The Radar app provides preset modes that can be used to quickly achieve the best picture depending on your current situation. Only Radar modes supported by your Radar scanner are shown.

To change Radar mode select the required mode from the Radar app menu.

Note:

Modes are not available on legacy Digital radomes (non-HD).

For the list of modes available with your radar scanner refer to:

[p.332 — Radar feature comparison](#)



[HARBOR]

Harbor mode takes into account land clutter that is typically encountered in a Harbor, so that smaller targets are still visible. This mode is useful when navigating in a Harbor.

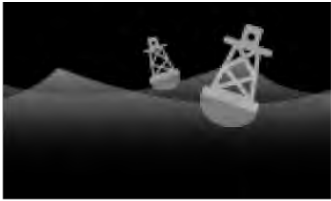

[BUOY]

Buoy mode enhances the detection of smaller targets such as mooring buoys, and is useful at ranges up to 3/4nm.



[COASTAL]

Coastal mode takes into account slightly higher levels of Sea clutter that are encountered out of Harbor areas. This mode is useful when in open water but keeping to coastal areas.



[OFFSHORE]

Offshore mode takes into account high levels of Sea clutter so that targets are still visible, useful when navigating in open water away from the coast.



[BIRD]

Bird mode optimizes the display to help identify flocks of birds, useful when trying to locate a fishing area.



[WEATHER]

Weather mode optimizes the display to help identify precipitation, useful for helping determine weather fronts.

22.7 Range rings

Range rings are evenly spaced concentric circles displayed on the screen that are centered on your vessel. Range rings enable you to easily estimate the distance between two points on the Radar screen.

By default range rings are set to automatic with the number of range rings displayed and spacing between them determined automatically by the Radar app's range.

The *[Range ring mode]* can be changed to *[Preferred number]*. When preferred number is selected you can specify your preferred number of range rings (i.e.: 2, 4, or 6). The number of preferred rings includes the azimuth ring.

Note:

Due to the relationship between range and ring spacing it is not always possible to display the preferred number at all ranges.

Range ring settings can be accessed from the Presentation tab: *[Menu > Presentation]*.

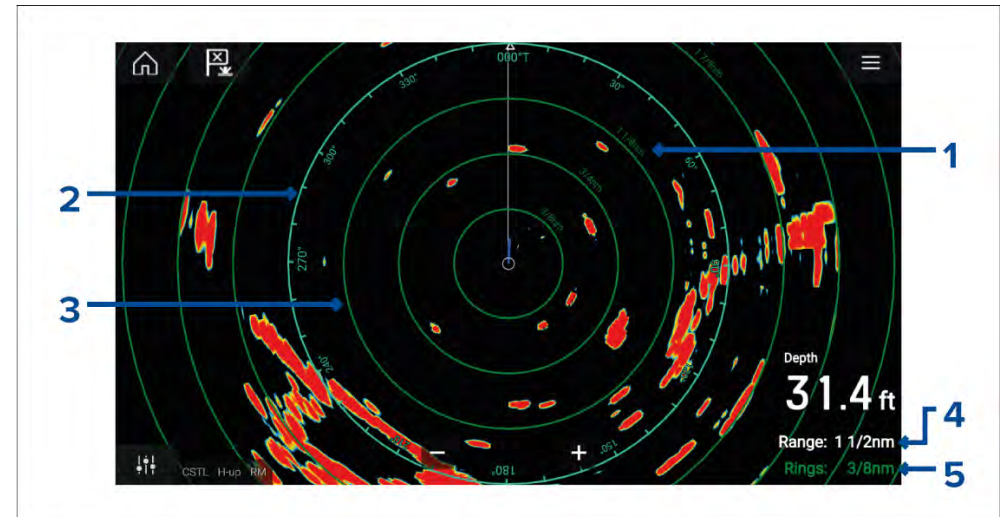

1. **Range ring distance** — each range ring includes the distance from your vessel.
2. **Azimuth ring** — The azimuth ring is the outermost range ring on the screen and is the farthest complete ring on the screen.
3. **Range ring** — evenly spaced concentric rings.

- Range** — shows the range displayed onscreen and is also the distance that the azimuth ring is placed at.
- Rings** — identifies the distance between each ring.

22.8 Range and bearing

The Radar app helps you identify a target's range (distance) and bearing from your vessel.

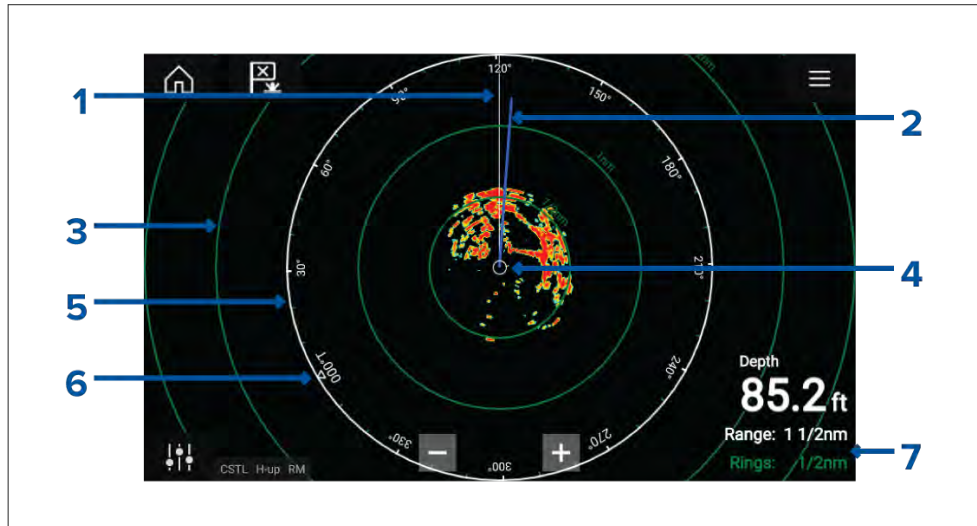

- SHM (Ships heading marker).
- COG/SOG line (Points in the direction of travel (COG), with the length of the vector providing an indication of speed (SOG)).
- Range rings.
- Vessel position.
- Azimuth ring (The White ring identifies the distance from your vessel to the top edge of the screen. Bearing indicators are also provided around the ring).
- North indicator (Always points North).
- Current displayed Range and Ring separation distance (Range: identifies the distance from your vessel to the top edge of the screen. Rings: identifies the distance between each Range Ring).

The displayed range can be adjusted at anytime using the Range controls.

Range rings can be switched off from the Presentation tab: *[Menu > Settings > Presentation > Range rings:]*

You can also choose whether to display a numerical range indicator against each ring using the *[Range ring labels:]* option.

VRM (Variable Range Marker) / EBL (Electronic Bearing Line)

VRM/EBL is used to determine a targets range and bearing from your vessel, or from another target. 2 VRM/EBLs are available which are enabled from the context menu.

[Context menu > More options > VRM/EBL 1] or *[Context menu > More options > VRM/EBL 2]*

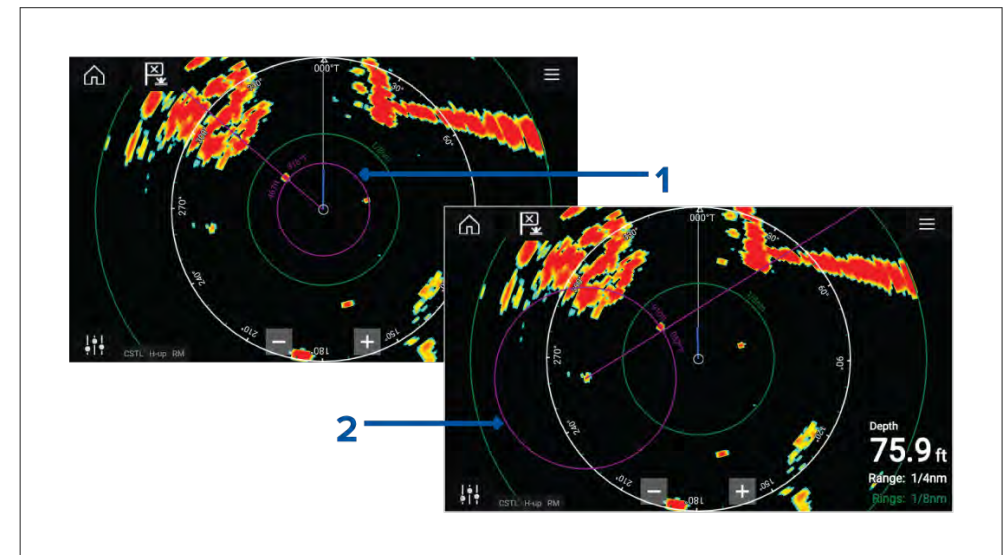

- Centered VRM/EBL** You can use a 'Centered' (on your vessel) VRM/EBL to determine the range and bearing of targets in relation to your vessel.
- Floating VRM/EBL** You can use a 'Floating' VRM/EBL to determine the range and bearing between 2 targets.

Editing a VRM-EBL

Once a VRM/EBL has been placed you can adjust its size and position.

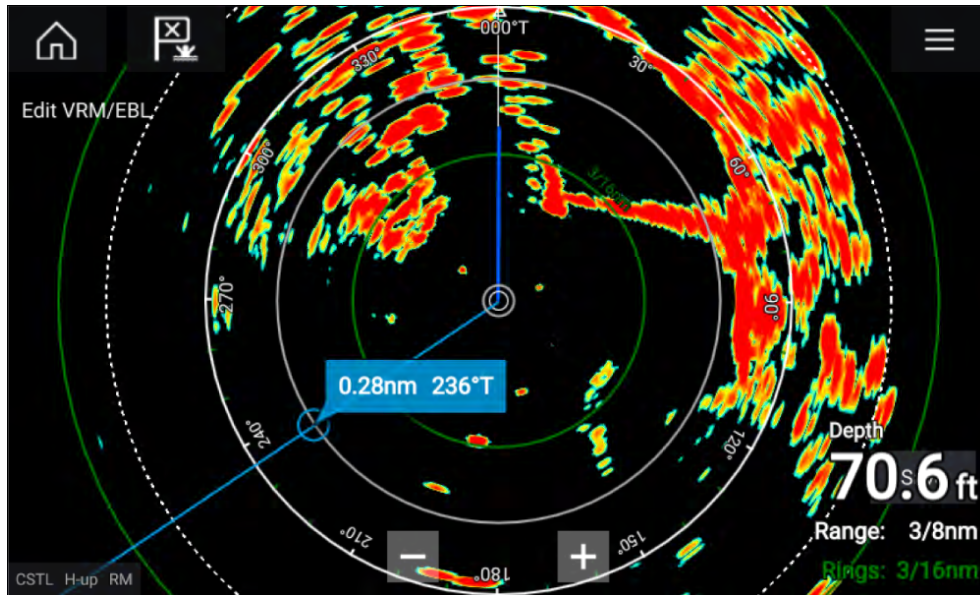

1. Select *[Edit VRM/EBL]* from the context menu.
2. To adjust the VRM/EBL select the desired target or drag the labelled circle to the target.
3. To create a floating VRM/EBL Drag the center circle to the desired target.

22.9 AIS targets

With compatible AIS hardware connected to your MFD, AIS targets can be automatically displayed in the Radar app.

Tracked AIS targets are identified onscreen using target symbols.

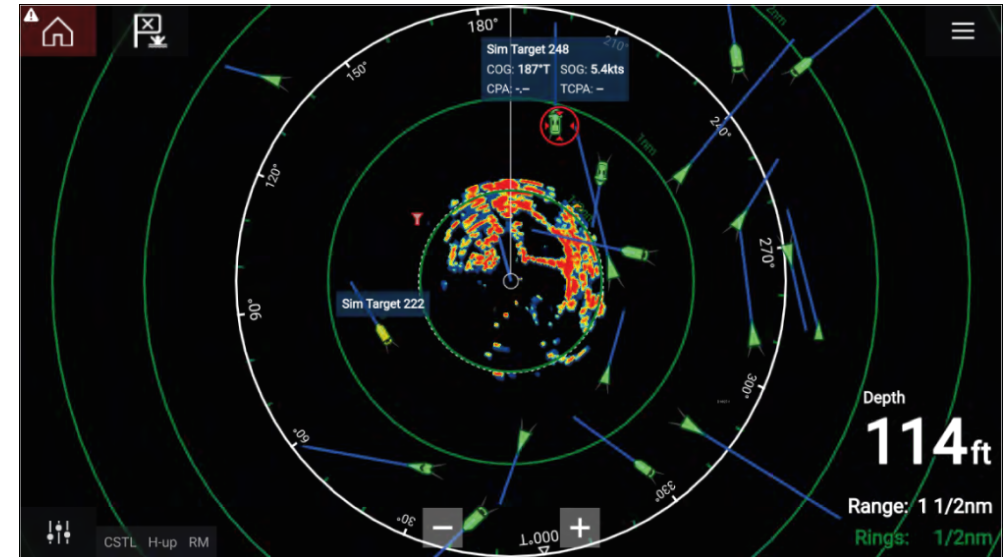

Target vectors and information can be displayed for each target by selecting the relevant option from the AIS target context menu. The AIS target context menu is accessed by selecting the AIS target.

You can also select the type of AIS targets that should be displayed, i.e.: *[All]*, *[Dangerous]*, *[Buddies]* and hide static targets from the AIS Settings tab.

AIS target capacity

The MFD can display a maximum of 200 AIS target simultaneously.

If more than 200 targets exist, within your range, the 200 targets nearest to your vessel will be displayed.

AIS target list

AIS targets appear in the AIS target list.

The AIS target list can be accessed by selecting the *[AIS]* tab from the *[Targets]* menu: *[Menu > Targets > AIS]*.



The list identifies: Target name and Range and Bearing (from your vessel). Where relevant, CPA (Closest point of approach) and TCPA (Time to Closest Point of Approach) values are also shown.

Selecting a target from the list will highlight the selected target in the *[LiveView]* pane on the right of the screen and display Pop-over options. Pop-over options enable you to *[View full target data]* or add an AIS target a buddy by selecting *[Add as buddy]*.







AIS icons used for targets marked as buddies will be filled yellow. You can also rename buddy targets or remove buddies using the Pop-over options.

AIS targets

When your MFD is connected to an AIS receiver or AIS transceiver AIS equipped vessels can be displayed as AIS targets in the Chart app and Radar apps. Different icons are used to represent different types of AIS target.







By default the following icons are used:

AIS icons

	Vessel		SART (Search and Rescue Transponder) / MOB (Man Over Board) / EPIRB (Emergency Position Indicating Radio Beacon)
	Land-based station		ATON
	SAR (Search and Rescue)		Virtual ATON

You can enable enhanced AIS target icons from the *[AIS Settings]* menu: *[Menu > Targets > AIS Settings > Enhanced AIS targets]* or the *[Advanced]* settings menu: *[Menu > Settings > Advanced > Enhanced AIS targets]*. When Enhanced AIS targets is enabled the Enhanced AIS icons are used.

Enhanced AIS icons







	Sailing Vessel		Commercial
	High speed vessel / Wing In Ground vessel		Cargo vessel
	Passenger vessel		Other

Enhanced AIS icons are scaled or outlined according to the reported size of the vessel, as shown below:

	Relative length (Gray outline)		
---	-----------------------------------	--	--

The status of an AIS target is shown using different colors, outlines and flashing as shown below:

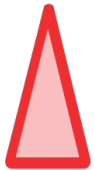
AIS target status

	Lost (No border, crossed through)		Uncertain (Dashed outline)
	Buddy (Yellow fill)		Dangerous and Uncertain (Dashed outline and Flashes Red)
	Dangerous (Flashes Red)		ATON off position (Red border)

Note:

When the MFD is configured as 'First responder' and is connected to STEDs compatible AIS hardware, Blue Force AIS icons are used to identify other STEDs equipped vessels. For details refer to: [p.376 – Blue Force Tracking](#)

AIS settings menu

You can configure AIS target settings from the *[AIS Settings]* menu: *[Menu > Targets > AIS Settings]*.

The following options are available:

- *[Show AIS targets in chart] / [Show AIS targets in Radar]* – Enables and disables display of AIS targets in the Chart app / Radar app.
- *[Enhanced AIS targets]* – Enables and disables the display of enhanced AIS target icons.

- *[AIS names]*— When enabled, AIS target names are permanently displayed next to AIS target icons.
- *[Show these AIS types]*— Enables selection of the types of AIS target that will be displayed. Available AIS types:
 - All
 - Dangerous
 - Buddies
- *[Hide static targets]*— When enabled, AIS targets travelling under 2 knots will not be displayed, unless it is or becomes dangerous.
- *[Silent mode (don't transmit my position)]*— When enabled, your vessel's AIS transceiver will not transmit your position or details to other AIS equipped vessels.

22.10 Radar targets

With a compatible Radar scanner connected to your MFD, radar targets can be tracked in the Chart app and Radar app. Depending on your Radar scanner, radar targets can be acquired manually or automatically, based on your configured *[Guard zones]*.

Tracked radar targets are identified onscreen using target symbols.

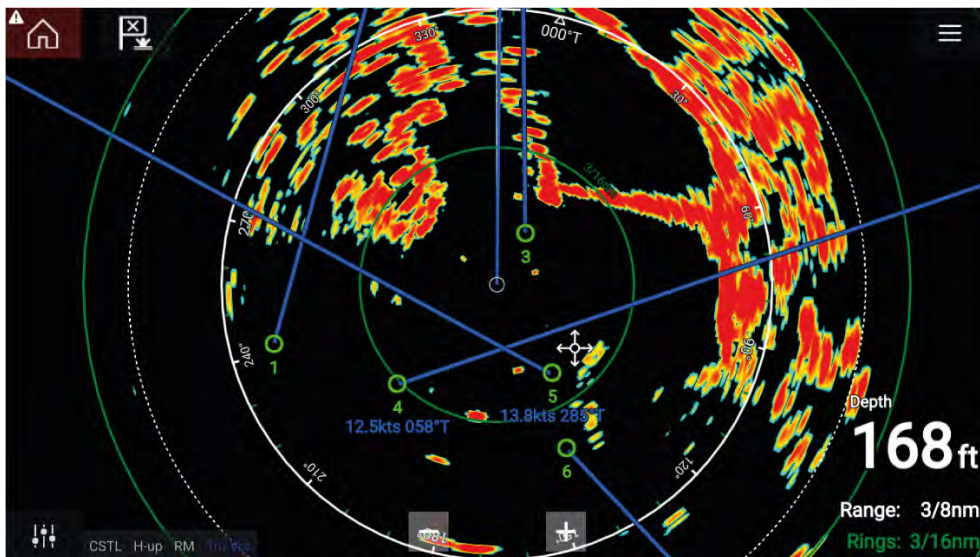

Multiple radar targets can be tracked simultaneously.

Target vectors and information can be displayed for each target.

Radar target options are available from the Radar target context menu. The Radar target context menu provides options for you to *[Cancel target]*, *[Show CPA]* graphic or display *[Target info]* onscreen by selecting the relevant option. The Radar context menu is accessed by selecting the radar target.

Radar target acquisition data source requirements





Radar target acquisition requires the following data sources to be available on your system (e.g. connected to your multifunction display, via SeaTalk NG or NMEA 0183).

Data type	Example data source
COG (Course Over Ground)	GNSS (GPS) receiver (multifunction display / chartplotter internal receiver or external receiver).
SOG (Speed Over Ground)	GNSS (GPS) receiver (multifunction display / chartplotter internal receiver or external receiver).
HDG / HDT (True Heading)	Compass or Autopilot sensor providing Fastheading data (e.g. Evolution EV-1 / EV-2).

Radar targets

Radar target symbols are used to identify Radar targets onscreen.

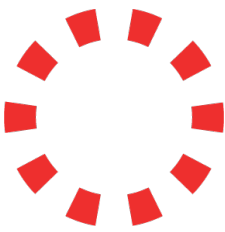
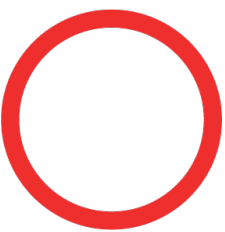
Radar targets are displayed in the Radar app and when Radar overlay is enabled (*[Chart app > Menu > Targets > Radar settings > RADAR OVERLAY > Show radar overlay]*) they are also displayed in the Chart app.

	Acquiring target (manual) — Thin dashed Green circle		Acquired target (manual) — Green circle with Target ID
	Acquiring target (auto) — Thick dashed Red circle, flashes until acknowledged		Unacknowledged acquired target (auto) — Red circle, flashes until acknowledged
	Dangerous target — Red circle with Target ID, flashes until acknowledged		Lost target (Target not detected for 4 Radar scans) — Gray circle with Red cross through

Once acquired the target's COG (Course Over Ground) and SOG (Speed Over Ground) can be displayed below the target ID.

The Target info is colored Blue if COG and SOG values are True or Orange if values are Relative. Target info will turn Red if the target becomes dangerous.

Acquiring a target manually

To acquire a Radar target manually using MARPA (Mini Automatic Radar Plotting Aid) follow the steps below.

1. Select the object / target.
The context menu is displayed.
2. Select *[Acquire target]*.
Once acquired the target will be tracked.

Automatic target acquisition

With a compatible Radar scanner connected, Radar targets can be acquired automatically.

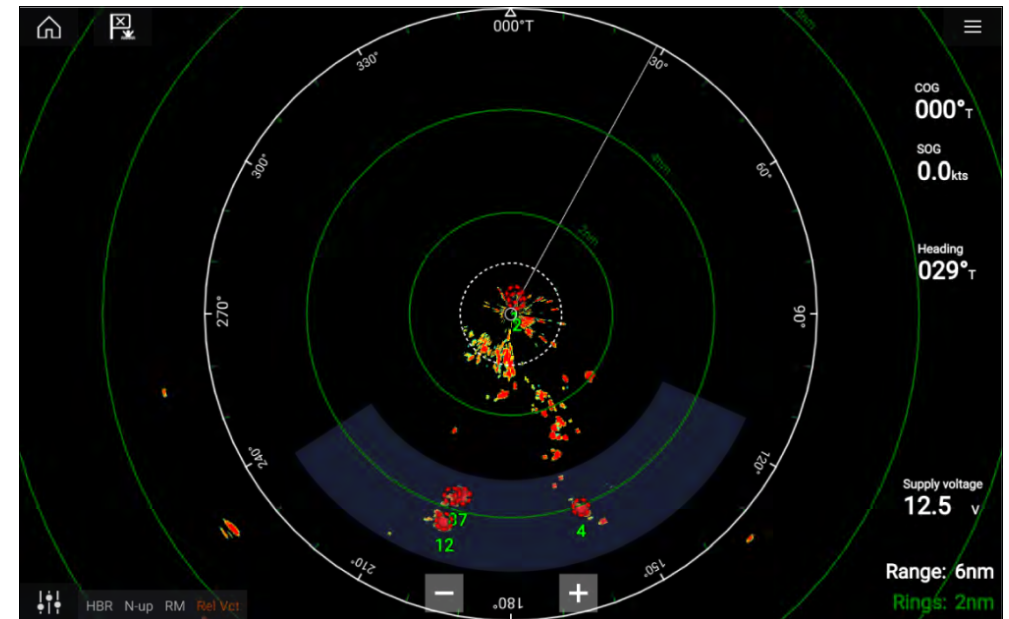

Once configured, targets which enter or appear in your chosen *[Guard Zone]*(s) will be automatically acquired.

Note:

- Automatic target acquisition cannot be enabled at the same time as *[Timed Transmit]* or *[Dual Range]*.
- Automatic target acquisition will be temporarily paused if the Radar display range is 12nm or greater.

Setting up automatic target acquisition

Follow the steps below to configure automatic target acquisition.

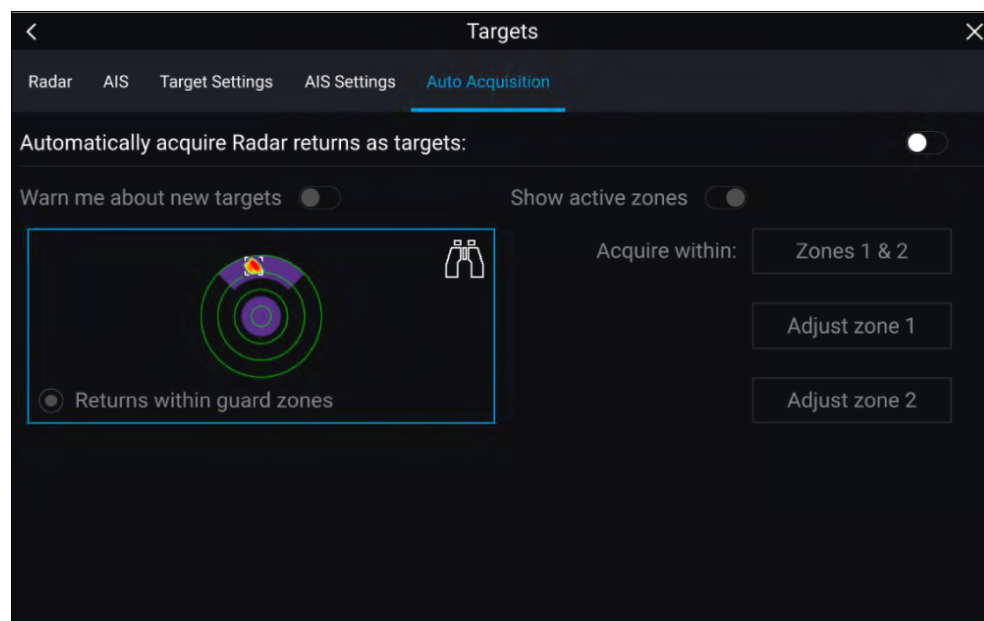

1. Select the *[Auto Acquisition]* tab from the Target menu: (*[Menu > Targets > Auto Acquisition]*).
2. Enable Automatic Target Acquisition by selecting the *[Automatically acquire Radar returns as targets]* toggle switch.
3. Select the *[Acquire within]* box and choose *[Guard zone 1]*, *[Guard zone 2]* or *[Zones 1 & 2]* as required.
4. To enable onscreen pop-up notifications of new targets which have been acquired automatically, select the *[Warn me about new targets]* toggle switch.
When multiple targets are acquired simultaneously, an Info dialog is displayed.
5. You can also adjust the size and position of the Guard zones directly from the *[Auto Acquisition]* page by selecting *[Adjust zone 1]* or *[Adjust zone 2]*.

Radar target list

The target list identifies: Target number, Range and Bearing from your vessel. Where relevant, CPA (Closest point of approach) and TCPA (Time to Closest Point of Approach) values will also be displayed.

The Radar target list can be accessed from the Targets menu in the Radar app and Chart app: *[Menu > Targets > Radar]*.

The Radar target list can be sorted by either *Number* or *Range* by selecting the *[Sorted By]* option located at the bottom of the LiveView pane:

- Number — List sorted by Target number so that the first detected target appears at the top of the list.
- Range — List sorted by proximity to your vessel with the closest target appearing at the top of the list. The list will automatically update as targets become closer or farther away.

Selecting a target from the list highlights the selected target in the LiveView app pane on the right of the page and opens the Pop-over menu.

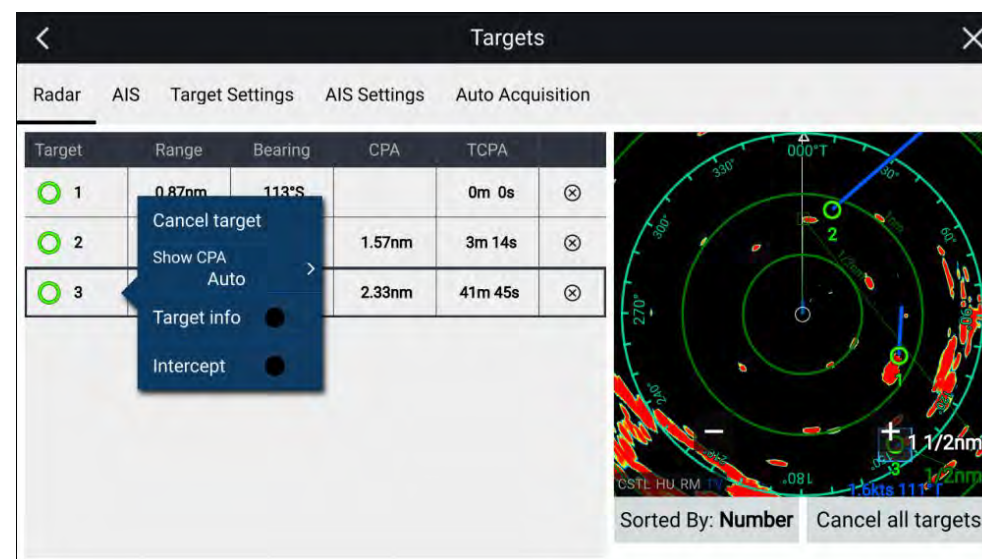

Radar targets can be cancelled individually by selecting the *[X]* next to the target's details in the list, or you can cancel all targets by selecting *[Cancel all targets]*.

Target settings

Target vectors, target history and object trail graphics can be displayed onscreen to improve situational and collision awareness.

Target settings can be accessed from the *[Target Settings]* tab: *[Menu > Targets > Target settings]*.

Reference mode

Target settings can be configured to either *[True]* or *[Relative]* mode. In True mode, Trails, Vectors and History are colored Blue and are shown ground referenced (i.e. the object or target's actual Course Over Ground (COG)). In Relative mode, Trails, Vectors and History are colored Orange and are shown relative to your vessel's movement.

To switch the target reference mode, select the *[REFERENCE MODE]* setting. Alternatively, you can switch reference mode by selecting the onscreen *[Image Adjustment]* icon and then selecting either *[True]* or *[Relative]*.

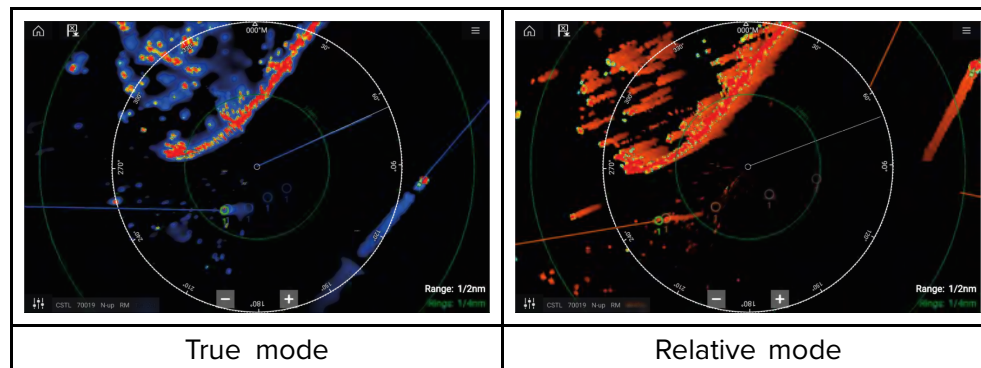

The *[Target Settings]* reference mode is independent of your vessel's motion mode.

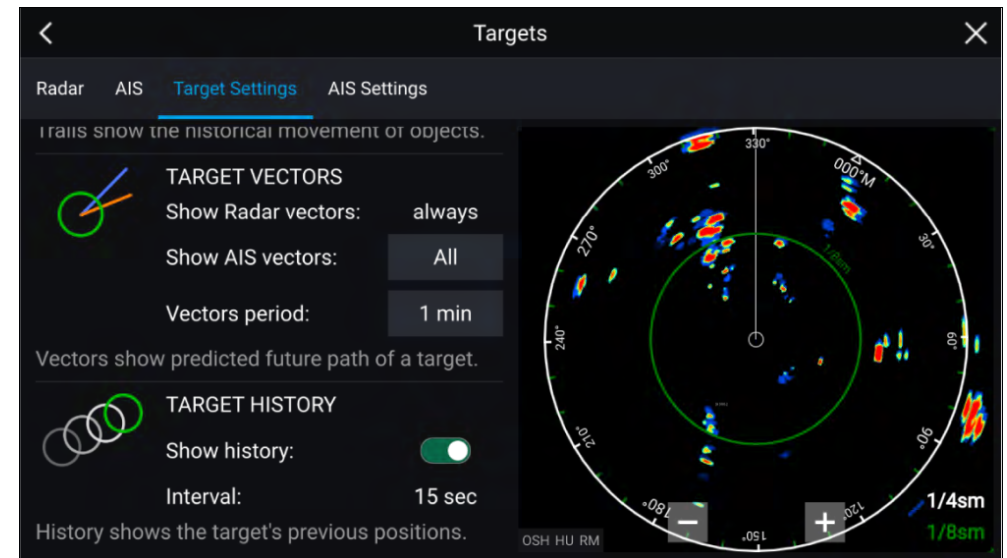

Target vectors

Target vectors show the predicted future course of a target.

Target vectors for acquired Radar targets are always shown. By default, target vectors are also shown for all AIS targets. You can switch the *[Show AIS vectors]* to *Manual*, enabling you to switch vectors for AIS targets *On* or *Off* for each target individually, via the target context menu.

The length of the Vector line signifies where the target will be after the time specified in *[Vector period]* has passed. The Vector period can be adjusted by selecting the current *[Vector period]* value and choosing a time from the Pop-over options.

Target history

Target history shows a target's previous positions.

Target history can be enabled or disabled using the *[Show history]* toggle switch.

Target history is plotted by displaying a target symbol at the vessel's position each time the value specified in the *[Interval]* setting has passed. The *[Interval]* is automatically calculated based on the target vector's *[Vector period]*, divided by 4.

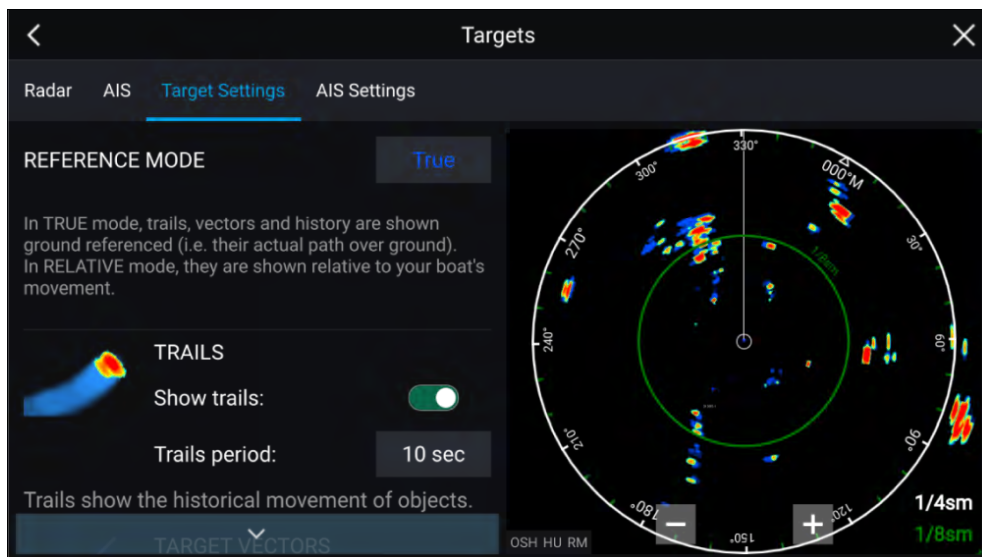

Trails

Trails plot the historical movements of objects (Radar returns) for the time specified in the *[Trails period]* setting.

Trails are subject to the selected “Reference Mode” (i.e. *[True]*, to show actual motion over “ground” (COG), or *[Relative]*, to show motion relative to your vessel).

Trails can be enabled and disabled using the *[Show trails]* toggle switch. Historical object position is shown as a colored trail behind the object.

Onscreen target settings

Target settings and information are also available using the onscreen *[Image adjustment]* icon.

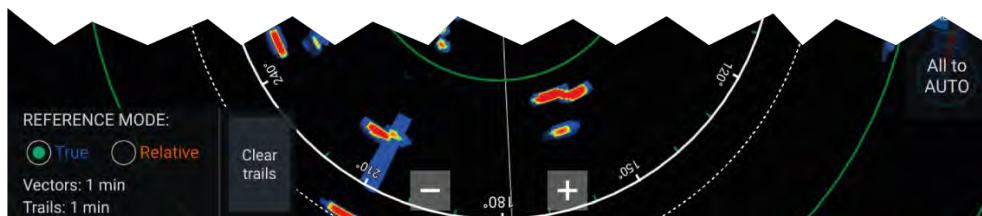

The following target settings and information is available:

- *[REFERENCE MODE]* — Choose whether Radar targets and objects are displayed in *[True]* or *[Relative]* reference mode.
- **Vector period and Trail interval** — Displays currently selected values.
- *[Clear trails]* — Clears and resets the trails displayed onscreen.

Clearing / resetting trails

In an area with multiple target returns, trails can clutter the Radar image, reducing its ability to provide a target’s path, under these circumstances you can remove all existing trails using the onscreen *[Clear trails]* option.

1. Select the onscreen *[Image adjustment]* icon.
2. Select *[Clear trails]*.

Target context menu

A target context menu is available that provides quick access to useful target settings.

To open the Radar target context menu, select a target onscreen.

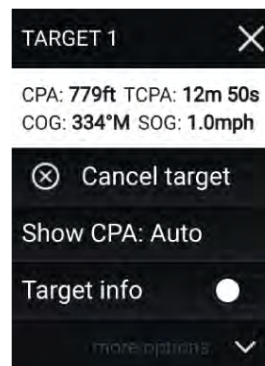

The Radar context menu provides CPA, TCPA, COG and SOG data for the selected target. The context menu also provides the following target menu options:

- *[Cancel target]* — The Radar target will no longer be tracked.
- *[Show CPA]* — Determines whether CPA graphics are shown. The default option is *Auto* which displays CPA graphics for the target if it becomes dangerous. You can also set CPA graphics to *On*, which displays CPA graphics, if there is an intersect point between your vessel’s current course and the target’s. When set to *Off* no CPA graphics will be displayed for the target.
- *[Target info]* — Determines whether the target’s SOG and COG information is displayed under the target onscreen.

22.11 Target data reference mode

In the Radar app the data shown in individual AIS and Radar target context menus can be switched between *[True]* and *[Relative]* reference mode.

Selecting either *[True]* or *[Relative]* from the *[Quick adjust]* menu will switch the reference data for all AIS and Radar targets.

Quick adjust menu

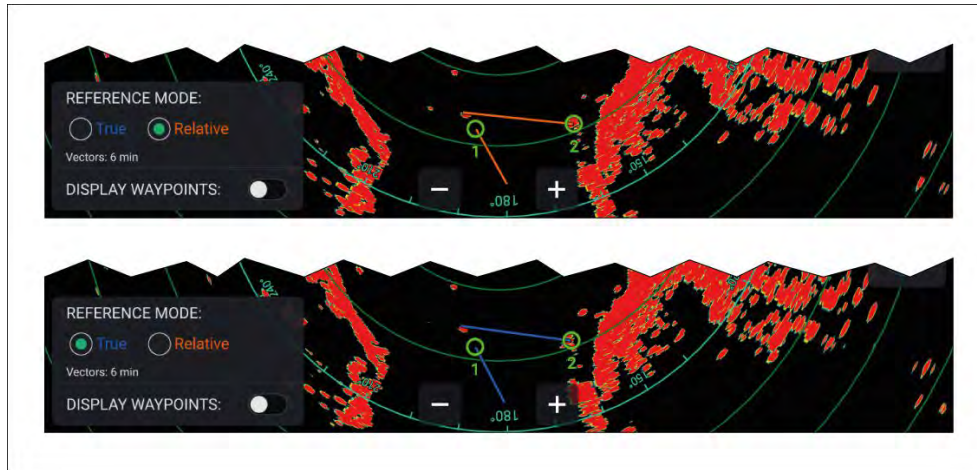

Selecting the *[True/Relative]* toggle switch from the target context menu will switch between *[True]* and *[Relative]* reference data for the selected target only.

Context menu

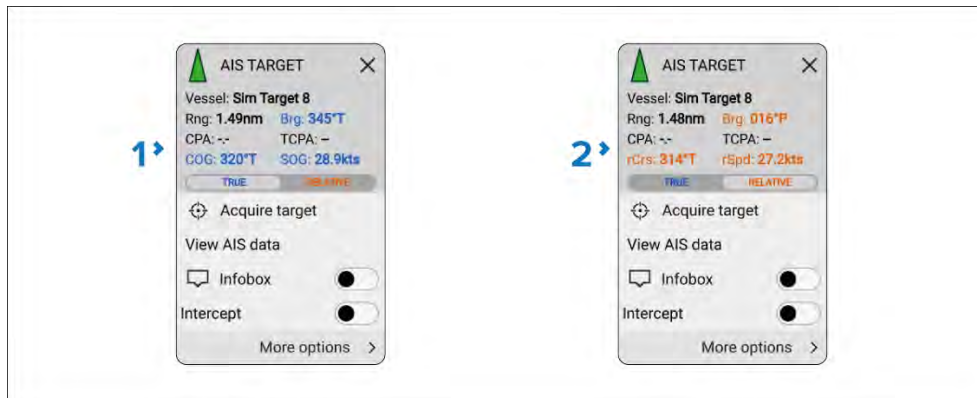

1. True data.
2. Relative data.

22.12 Dangerous targets alarm

You can use the Dangerous targets alarm to notify you if a Radar or AIS target will reach a specified distance from your vessel within a specified time.

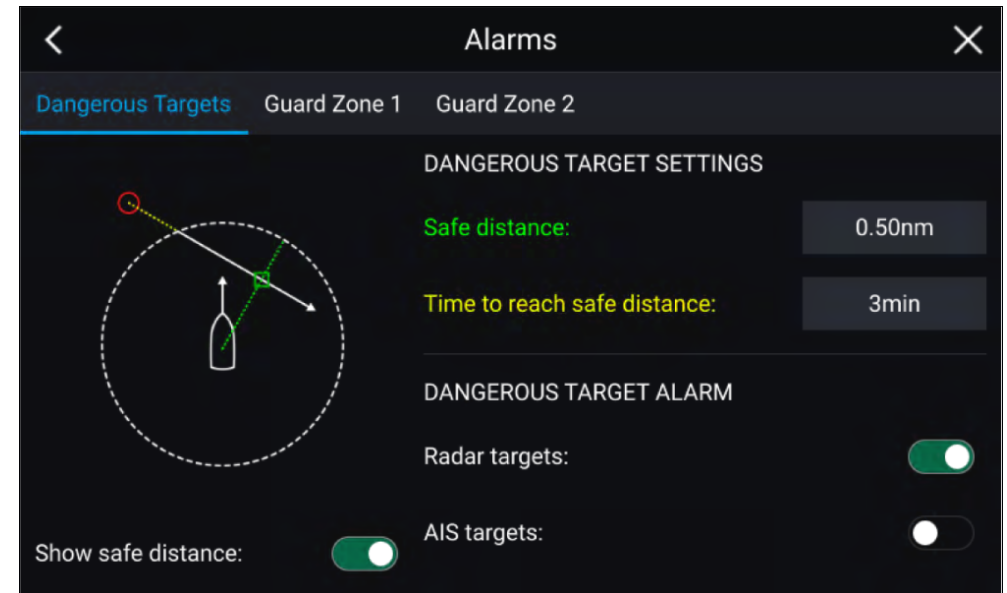

To set up the Dangerous target alarm, first adjust the *[Safe distance]* to the desired value and then select a *[Time to reach safe distance]*. The alarm will be triggered if a tracked target will reach the specified Safe distance from your vessel within the time period selected.

You can choose whether you want the Dangerous target alarm to trigger for Radar and / or AIS targets.

You can display a Safe distance ring around your vessel in the Radar app using the *[Show safe distance]* control.

22.13 Guard zone alarms

Guard zones alert you if a Radar return is detected within the Guard zone area.

2 Guard zones can be configured for each connected Radar scanner.

The Guard zones can be configured from the *[Alarms]* menu: *[Menu > Alarms > Guard zone 1]* or *[Menu > Alarms > Guard zone 2]*

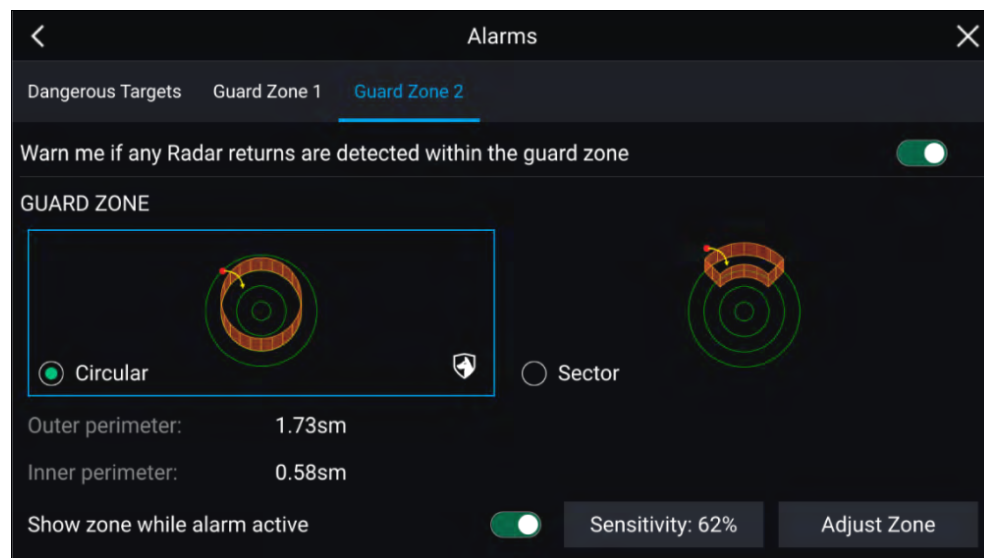

A Guard zone can be configured as a sector or as a circle around your vessel. Selecting *[Adjust Zone]* allows you to configure the size of the Guard Zone.



Adjust the guard zone's size by dragging the inner and outer perimeter end points (circles) to the desired locations.

Once configure select *[Back]*.

If required, you can also adjust the Guard zone sensitivity. Sensitivity determines the size at which objects trigger the alarm.

22.14 Doppler Radar overview

Doppler Radar technology makes it easier to track moving objects with ground speed exceeding 3 knots.

The Doppler function highlights objects on the Radar display that are moving towards or away from the vessel (e.g. other vessels, but not land or buoys, for example). Stationary targets will not be highlighted.

Doppler Radar technology is particularly beneficial in a marine environment, where poor weather conditions and visibility can make object tracking challenging. With the integration of Doppler information on the Radar display, the process of matching on-screen Radar returns with real-world objects becomes a much simpler task.

Doppler Radar works by transmitting a microwave signal which is then reflected off a moving object at a distance. By analyzing how the object's motion has altered the frequency of the returned signal, the Doppler Radar can interpret the variation to provide highly accurate measurements of an object's direction of travel, relative to the Radar scanner.

Doppler mode

When a compatible Radar scanner is connected, Doppler mode is available.

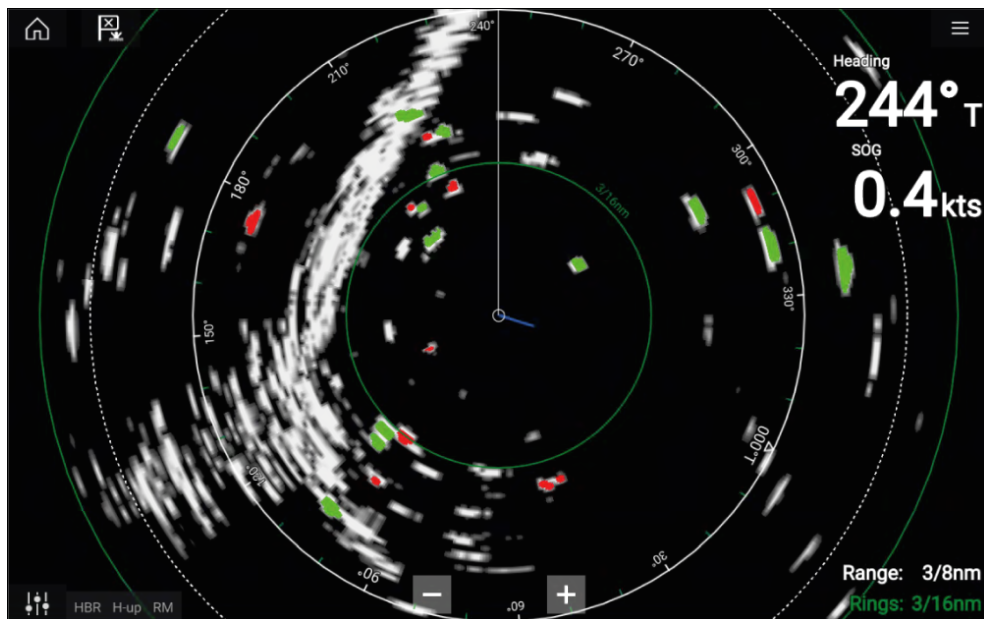

Doppler mode — Enabling and disabling

Doppler mode is enabled from the Main menu: *[Menu > Doppler]*.

With Doppler mode enabled, the color palette will change to the default Doppler palette: All approaching targets will be colored Red, and all targets moving away from you will be colored Green.

Doppler mode is suspended at ranges of 12 nm and greater. The Radar color palette will remain the same but targets will not be highlighted.

Doppler mode — Color palettes

Doppler has unique color palettes which help to ensure the Red and Green Doppler targets stand out from the Radar image. When Doppler is enabled, the standard color palette setting will show only the unique Doppler color palettes: *[Doppler grey]*, *[Doppler blue]* and *[Doppler yellow]*. A *[Full Color]* option is also available.

Note:

If 'Full color' is selected for the Radar palette, approaching targets will appear Pink instead of Red.

The Color palettes can be selected from the Presentation tab: *[Menu > Settings > Presentation]*.

Caution: Doppler limitations

When the target's speed is more than 60 knots Speed Over Ground (SOG), or the relative speed between your vessel and the target is greater than 120 knots, the direction of target returns from high speed vessels may be displayed incorrectly. Consequently, **the displayed target colors may be inverted, with targets colored red when they should be green, and vice versa.**

Doppler data source requirements

Use of the Doppler Radar features requires the following data sources to be available on your system (e.g. connected to your multifunction display, via SeaTalkng® or NMEA 0183).

Required data sources

Data type	Example data source
COG (Course Over Ground)	GPS or GNSS receiver (MFD internal receiver or external receiver).
SOG (Speed Over Ground)	GPS or GNSS receiver (MFD internal receiver or external receiver).

Recommended data source

Data type	Example data source
HDG / HDT (True Heading)	Compass or Autopilot sensor providing Fastheading data (e.g. Evolution EV-1 / EV-2).

Note:

A heading data source is not essential for Doppler operation. However it will improve the performance of Doppler mode at slower speeds (< 15 knots), when tide set and leeway are present.

22.15 Blank sectors

Blank sectors can be manually set to hide specific sections of your radar display.

This feature is useful for vessels that experience false radar readings from onboard structures or equipment.

As blanking also physically disables the scanner's transmitter for the sector that you define, this feature is also useful for protecting crew members from radar radio frequency emissions when they are in close proximity to the radar antenna. One example of this scenario is when the helm is within the beamwidth of the radar antenna.

Note:

Sector blanking is only available with Cyclone solid state open array, Magnum™ Open Array and Quantum™ 2 Doppler running Radar software version 2.46 or above.

Blank sectors can be enabled from the Radar app settings: *[Radar app > Settings menu > Installation]*

Two blank sectors can be enabled. You can edit the minimum and maximum limits of each blank sector; this will determine how much of the radar display is hidden.

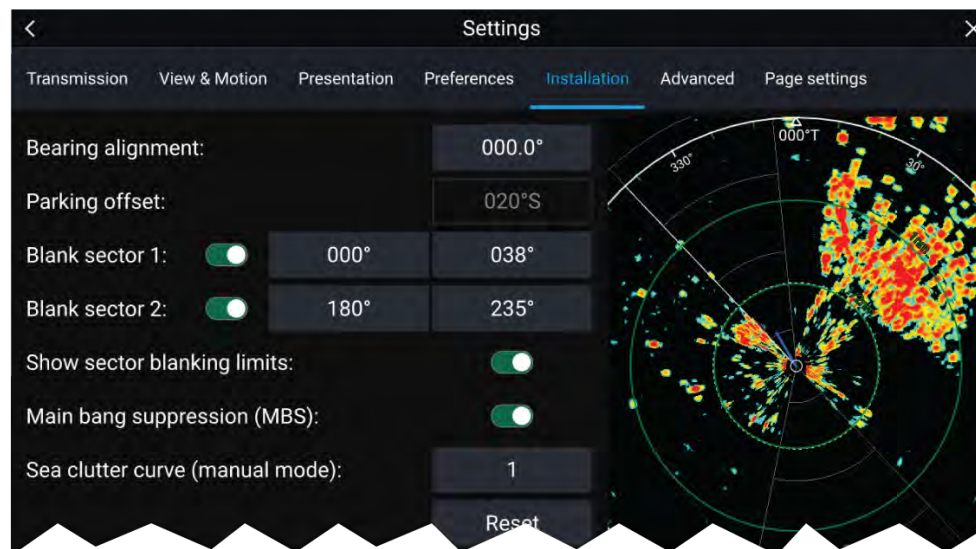

Blank sectors can be enabled / disabled on the radar overlay in the Chart app: *[Chart app > Settings menu > Radar settings]*

For more information refer to [Radar settings](#)

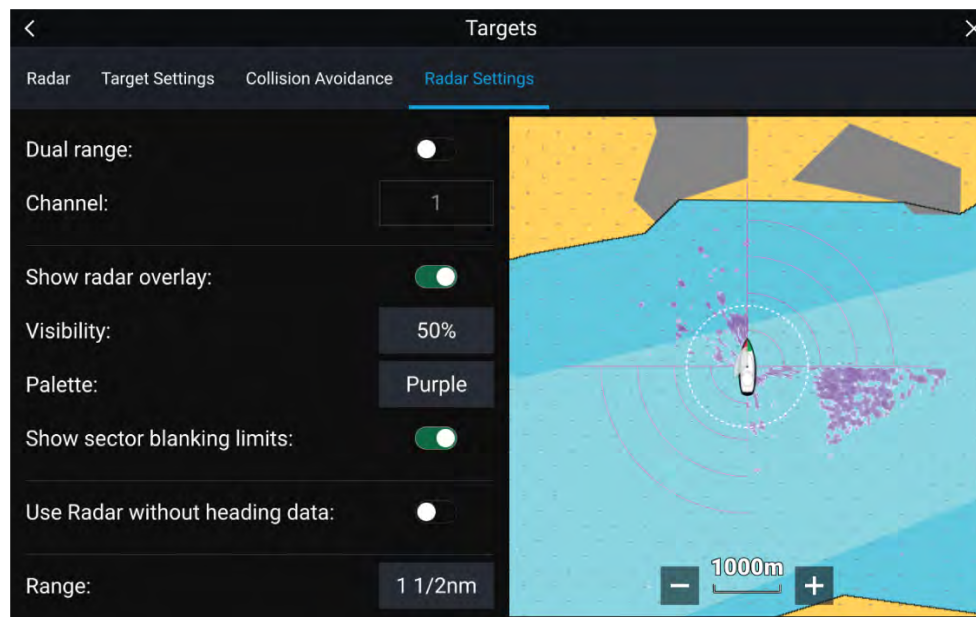

22.16 Radar sensitivity controls

Optimum performance is usually achieved using the default settings. You can adjust the image using the Sensitivity controls to improve the displayed image.



Sensitivity settings can be accessed using the onscreen *[Image adjustment]* icon, or the Adjust sensitivity menu option: *[Menu > Adjust sensitivity]*.

The Sensitivity controls available are dependant upon the Radar scanner in use.

Control	Name	Description
	<i>['G' Gain]</i>	The control determines the signal strength at which target returns are shown onscreen. The Gain control can be set to <i>[Auto]</i> or <i>[Manual]</i> . A higher value produces more target returns and noise onscreen.
	<i>['R' Rain]</i>	Precipitation appears on the Radar screen as lots of small echoes which continuously change size, intensity and position. The Rain control suppresses these echoes making it easier to identify real object. The higher the Rain control is set the more echoes will be suppressed.
	<i>['S' Sea]</i>	Radar echoes from waves can clutter the Radar screen. The Sea control suppresses these echoes (for up to 5 nm depending on conditions) making it easier to identify real objects. The higher the Sea control is set the more echoes will be suppressed.

Control	Name	Description
	<i>['CG' Color Gain]</i>	The control sets the lower limit for the color used for the strongest target returns. All target returns above this value are displayed in the strongest color. Those with a weaker value are divided equally between the remaining colors. The control can be set to <i>[Auto]</i> or <i>[Manual]</i> .
	<i>[All to Auto]</i>	Sets all Sensitivity settings to <i>[Auto]</i> with 0% offset.

22.17 Radar settings menus

The radar settings menu is organized into tabs with settings and options appearing under the relevant tab. The following settings menus are available:

- *[Transmission]* For details refer to: [p.354 – Transmission settings menu](#)
- *[View & Motion]* For details refer to: [p.354 – View & Motion settings menu](#)
- *[Presentation]* For details refer to: [p.355 – Presentation settings menu](#)
- *[Preferences]* For details refer to: [p.356 – Preferences settings menu](#)
- *[Installation]* For details refer to: [p.356 – Installation settings menu](#)
- *[Advanced]* For details refer to: [p.357 – Advanced settings menu](#)
- *[Page settings]* For details refer to: [p.358 – Page settings menu](#)

Transmission settings menu

The transmission settings menu provides options relating to radar scanner selection and operation.

Menu item and description	Options
<i>[Scanner]</i> Allows you to select the radar scanner that you want to use. (In systems featuring multiple connected radar scanners).	List of available Radar scanners.
<i>[Channel shown in this app]</i> Determines which channel is shown in the radar app.	<ul style="list-style-type: none"> • Channel 1 (Long range) • Channel 2 (Short range)
<i>[Antenna size selection]</i> Open array radar antenna size selection.	<ul style="list-style-type: none"> • 4ft • 6ft
<i>[Timed transmit]</i> Enables and disables Timed transmit. Timed transmit configures your radar to transmit at periodic intervals to conserve power.	<ul style="list-style-type: none"> • On • Off
<i>[Standby]</i> Determines the length of time the radar is in Standby for in time transmit mode.	<ul style="list-style-type: none"> • 3 min • 5 min • 10 min • 15 min
<i>[Transmit]</i> Determines the amount of scans the radar will perform when transmitting in time transmit mode.	<ul style="list-style-type: none"> • 10 scans • 20 scans • 30 scans

Menu item and description	Options
<i>[Dual range]</i> Enables and disables dual range, which enables you to display 2 different ranges simultaneously.	<ul style="list-style-type: none"> • On • Off
<i>[Range Fusion]</i> Enables the Range Fusion feature when using dual range on Cyclone radar scanners. With Range Fusion, short and long pulses are combined to provide a high-clarity Radar image for both short-range and long-range targets, simultaneously.	<ul style="list-style-type: none"> • On • Off
<p>Note: Option only available on Cyclone radar scanners.</p>	

View & Motion settings menu

The view and motion settings menu contains settings that allow you to control how the radar is displayed in relation to your vessel.

Menu item and description	Options
<p><i>[Orientation]</i></p> <p>Head-up The top of the screen always points towards your vessel's current heading and as your heading changes the Radar image rotates accordingly. In Head-up the motion mode is fixed to Relative motion.</p> <p>North-up The radar image is orientated so that true north is always upward on the screen. As your vessel changes direction the SHM (ship heading marker) rotates accordingly to show your relative position to true north.</p> <p>Course-up The radar is orientated so as to show your current course directly ahead. The radar image will rotate so that your COG is always upward on the screen, as your heading changes the SHM rotates accordingly.</p>	<ul style="list-style-type: none"> • Head-up • North-up • Course-up
<p><i>[Motion mode]</i></p> <p>Relative motion Relative Motion mode fixes your vessel's position and the radar image moves relative to your vessel In Relative motion mode you can adjust your vessel's onscreen position using the Boat position setting.</p> <p>True motion True Motion mode fixes the chart position and the vessel icon moves across the screen. As the vessel's position approaches the edge of the screen, the chart image is automatically redrawn to reveal the area ahead of the vessel. As the vessel's position approaches the edge of the display, the image is automatically redrawn to reveal the area ahead of the vessel. In True motion mode the boat position is fixed to <i>[Full offset]</i>.</p> <hr/> <p>Note: True Motion mode is not available when the Radar orientation is set to "Head-up".</p>	<ul style="list-style-type: none"> • Relative motion • True motion
<p><i>[Boat position]</i></p>	<ul style="list-style-type: none"> • Center

Menu item and description	Options
<p>The boat position determines the position of your vessel onscreen. You can adjust the Boat position to provide a greater distance ahead of your vessel. Your boat position can only be changed in <i>[Relative motion]</i> mode.</p>	<ul style="list-style-type: none"> • Partial offset • Full offset

Presentation settings menu

The presentation settings menu provides options for what is displayed on the screen.

Menu item and description	Options
<p><i>[Range rings]</i> Enables and disables Range rings in the Radar app.</p>	<ul style="list-style-type: none"> • On • Off
<p><i>[Range ring labels]</i> Enables and disables Range ring distance labels in the Radar app.</p>	<ul style="list-style-type: none"> • On • Off
<p><i>[Range ring mode]</i> The number of Range rings displayed in the Radar app can be either set automatically according to the displayed range or you can specify a preferred number of range rings.</p>	<ul style="list-style-type: none"> • <i>Auto</i> • <i>Preferred number</i>
<p><i>[Rings]</i> When Range ring mode is set to Preferred number use this setting to specify your preferred number.</p>	<ul style="list-style-type: none"> • 2 • 4 • 6
<p><i>[Color palette]</i> Allows selection of the color palette.</p>	List of color palettes.
<p><i>[Show waypoints]</i> Allows the display of waypoint icons in the Radar app.</p>	<ul style="list-style-type: none"> • <i>On</i> • <i>Off</i>

Preferences settings menu

The preferences settings menu provides options to help you customize your Radar to your personal preference.

Description	Options
<i>[VRM/EBL reference]</i> Determines the reference point used for VRM/EBLs.	<ul style="list-style-type: none"> • True/Mag • Relative
<i>[Interference rejection]</i> Suppresses interference from other Radar scanners in the vicinity.	<ul style="list-style-type: none"> • On • Off
<i>[Interference rejection level]</i> Determines the amount of interference suppression used. Only available when <i>[Interference rejection]</i> is enabled.	<p>Quantum™ / Cyclone</p> <ul style="list-style-type: none"> • Level 1 to Level 5 <p>Non-HD Digital Radomes</p> <ul style="list-style-type: none"> • Normal • High
<i>[Near Target Enhancement]</i> The size of targets within the first half of the displayed range will be increased to provide a more consistent size of targets as they approach your vessel (i.e. the center of the screen).	<ul style="list-style-type: none"> • On • Off
Note: Option only available on Cyclone radar scanners.	
<i>[Expanded returns]</i> When enabled, increases the Radar pulse length to provide larger target returns.	<ul style="list-style-type: none"> • On • Off
<i>[Expansion level]</i> Determines the amount of target expansion applied. Only available when <i>[Target expansion]</i> is enabled.	<ul style="list-style-type: none"> • Low • High

Description	Options
<i>[Tune adjust]</i> Allows you to adjust the Radar scanner's receiver for maximum target returns. It is recommended that the Radar scanner is allowed to warm up for at least 10 minutes prior to making adjustments.	<ul style="list-style-type: none"> • Auto • Manual (0% to 100%)
<i>[Radar Rotation Speed]</i> Allows you to select the appropriate rotation speed for your range. The Auto option provides an increased refresh rate at Radar ranges up to 3 nm.	<ul style="list-style-type: none"> • 24 RPM • Auto (24 / 48 RPM)
<i>[Transmit frequency]</i> Changing the Transmit frequency can reduce interference on the Radar image.	<ul style="list-style-type: none"> • Low • Normal • High
<i>[Beam sharpening]</i> Reduces the beamwidth of the Radar by the amount specified in <i>[Beam sharpening amount]</i> , to produce targets that have less resolution, which makes it easier to identify targets that are close together. Intended for Radars with 3 ft or 4 ft antennas, which have less beamwidth than a 6 ft antenna.	<ul style="list-style-type: none"> • On • Off
Note: Option only available on Cyclone radar scanners.	
<i>[Beam sharpening amount]</i> Percentage of the beamwidth reduction for the Radar's <i>[Beam sharpening]</i> feature.	<ul style="list-style-type: none"> • 0% to 100%

Installation settings menu

The installation settings menu provides options used during installation to help set up your radar

During normal operation it should not be necessary to adjust Installation settings.

Menu item and description	Options
<i>[Bearing alignment]</i> Enables you to align the Radar image correctly in relation to your vessel's bow. Correct alignment is necessary for the accurate display of radar returns and targets.	<ul style="list-style-type: none"> • 179.5° Port to 180° Starboard
<i>[Parking offset]</i> Allows you to select the “parked” position of your Open Array's antenna, which is the physical position that the antenna will be in, relative to the pedestal when the radar is in Standby. This feature is only available when the Open Array radar scanner is in Standby.	<ul style="list-style-type: none"> • 0° to 359°
<i>[Blank sector 1]</i> Allows you to hide a specific section of the radar display, creating a “blank” sector onscreen that shows no radar signal returns.	<ul style="list-style-type: none"> • 0° to 359° • 0° to 10° (default)
Note: Sector blanking is only available with Cyclone solid state open array, Magnum™ Open Array and Quantum™ 2 Doppler running Radar software version 2.46 or above.	
<i>[Blank sector 2]</i> Allows you to hide an additional section of the radar display, creating a “blank” sector onscreen that shows no radar signal returns.	<ul style="list-style-type: none"> • 0° to 359° • 180° to 190° (default)
Note: Sector blanking is only available with Cyclone solid state open array, Magnum™ Open Array and Quantum™ 2 Doppler running Radar software version 2.46 or above.	

Menu item and description	Options
<i>[Main Bang Suppression (MBS)]</i> MBS eliminates saturation in radar returns displayed in the immediate vicinity of your vessel. When adjusting <i>[Zero range]</i> it is recommended that MBS is set to Off.	<ul style="list-style-type: none"> • Off • On
<i>[Sea clutter curve]</i> Adjusts the Radar scanner's sensitivity to Sea clutter.	<ul style="list-style-type: none"> • 1 to 8
<i>[Wired adapter channel (requires Radar reboot)]</i> Changes channel to eliminate noise. For details refer to: p.522 – Changing Quantum radar channel	<ul style="list-style-type: none"> • 1 to 11
<i>[Set scanner's zero rotation position]</i> The Zero position is set in the factory. It should only need changing if the slip ring has been replaced or if the unit has been taken apart.	Set
<i>[Reset]</i> Reset the Radar's settings to their factory default values.	N/A

Advanced settings menu

The advanced settings menu contains advanced settings related to the radar.

During normal operation it should not be necessary to adjust Installation settings.

Menu item and description	Options
<i>[Tune preset]</i> Radar tuning is controlled either automatically or manually, using the <i>[Tune adjust]</i> setting. Tune preset controls the range available to the <i>[Tune adjust]</i> control.	<ul style="list-style-type: none"> • 0 to 255
<i>[STC preset]</i> The Sensitivity Time Control (STC) can be used to equalize targets across the image. If you find targets are brighter or dimmer nearer the center of the image adjust the STC preset until the desired result is achieved.	<ul style="list-style-type: none"> • 0% to 100%

Menu item and description	Options
<p><i>[Zero range]</i> Zero range (Display timing) is used to configure the zero range of the Radar scanner so that objects appear at the correct distance.</p>	<ul style="list-style-type: none"> • 0 to 153m / 502ft
<p><i>[Reset]</i> Resets Installation and advanced settings to factory defaults.</p>	<ul style="list-style-type: none"> • Yes • No

Page settings menu

The page settings menu contains settings related to page layout.

The following options are available:

- *[Data Overlays]*— Enables configuration of Data overlays, which overlay key information from connected sensors onto the Chart, Radar, Sonar and Camera apps.
- *[Edit split ratio]*— Enables you to customize the position of the partitions in splitscreen app pages. For example, 50/50, 70/30 etc.

CHAPTER 23: FIRST RESPONDER

CHAPTER CONTENTS

- 23.1 First responder features — page 360
- 23.2 Lost depth alarm — page 363
- 23.3 Heading and SOG Homescreen status — page 363
- 23.4 Settings password protection — page 363
- 23.5 Data logging — page 364
- 23.6 Waypoint at Range and Bearing from location — page 365
- 23.7 Route sending and receiving — page 365
- 23.8 Intel targets — page 369
- 23.9 DSC targets — page 371
- 23.10 Target Of Interest (TOI) — page 372
- 23.11 First responder AIS modes — page 375
- 23.12 AIS high target alarm — page 376
- 23.13 SITREP (Situation report) — page 376
- 23.14 First responder target context menus — page 377
- 23.15 Depth markers — page 378
- 23.16 Import and export Waypoints and Routes over NMEA networks — page 378

23.1 First responder features

Configuring the MFD for First responders enables extra features that are otherwise not available on the MFD. Several of the First responder features require a STEDs compatible AIS transceiver to enable Sensitive Tactical Information Exchange and Display System (STEDS) functionality.

First responder and STEDS features require *[First responder]* to be selected as the 'Boating activity' during step 2 of the MFD's initial startup wizard.

Note:

To change boating activity a factory reset must be performed to initiate the startup wizard.

STEDS specific features also require

- an AIS5000 to be connected to the same NMEA 2000 / SeaTalkng[®] network as the MFD.

Note: The AIS5000 must be correctly configured with an MMSI number and where required a radio operators license must be obtained.

- each vessel must be configured with the same STEDS passphrase.

STEDS features use the existing Automatic Identification System (AIS) network to transmit and receive messages and data but as the messages and data are encrypted they are not visible or available to standard Class A and Class B AIS receivers/ transceivers.

STEDS encryption

The encryption is 128bit AES encryption which is compliant with the requirements of FIPS (Federal Information Processing Standard Publication). The symmetric STEDS passphrase is used to encrypt and decrypt STEDS messages to ensure that only vessels with MFDs configured with the same passphrase can send and receive the messages.

e.g. If another law enforcement geographically close to your network of vessels also uses the STEDs encrypted MFD functionality, unless they have a matching key there cannot be any interaction between the 2 agencies, and instead each agency will see the other's vessels as a normal AIS target (providing they aren't in AIS restricted mode).

Note:

On an MFD network only the Data master MFD needs to be configured.

First responder features

The following features are available when the MFD is configured as 'First responder'

- The *[Responder]* settings menu tab is available and the *[Responder vessel type]* can be selected. For details refer to [p.361 — Responder settings](#)
- Data logging is enabled. For details refer to [p.364 — Data logging](#)
- DSC target tracking are enabled. For details refer to [p.371 — DSC targets](#)
- Intel target tracking is available. For details refer to [p.369 — Intel targets](#)
- LightHouse™ charts obstruction alarm is available For details refer to [p.236 — Obstruction alarm \(legacy LightHouse charts\)](#)
- Settings password protection. For details refer to [p.363 — Settings password protection](#)
- Place waypoint at range and bearing. For details refer to [p.365 — Waypoint at Range and Bearing from location](#)
- Homescreen Heading and SOG indication. For details refer to [p.363 — Heading and SOG Homescreen status](#)
- Depth monitoring / lost depth alarm. For details refer to [p.363 — Lost depth alarm](#)
- Importing and exporting waypoints and Routes over NMEA networks. For details refer to [p.378 — Import and export Waypoints and Routes over NMEA networks](#)
- Placing horizontal depth markers in the sonar app. For details refer to [p.378 — Depth markers](#)
- AIS maximum/high targets alarm. For details refer to [p.376 — AIS high target alarm](#)

First responder STEDS features

The following STEDS features are available when the MFD is configured as 'First responder' and the STEDS requirements have been met

- The STEDS text messaging app is available. For details refer to [p.385 — Messaging app](#)

- SITREP status can be configured. For details refer to [p.376 — SITREP \(Situation report\)](#)
- AIS restricted mode is available. For details refer to [p.375 — First responder AIS modes](#)
- Targets of Interest (TOI) feature is enabled. For details refer to [p.372 — Target Of Interest \(TOI\)](#)
- Blue Force tracking is used to identify other STEDS configured vessels. For details refer to [p.376 — Blue Force Tracking](#)
- Managed and un-managed Search and Rescue (SAR) patterns can be broadcast and received over STEDS messaging. For details refer to [p.179 — SAR pattern broadcast and receipt](#)
- Routes can be broadcast and received over STEDS messaging. For details refer to: [p.365 — Route broadcast and receipt](#)

LightHouse software updates for STEDS enabled systems

Data sent or received using STEDS messaging will be erased when the MFD's software is updated.

The following data will be erased:

- Inbox messages
- SAR patterns
- Targets of interest

Responder settings

The Responder menu tab is only available when *[First responder]* is selected as the 'Boating activity' during step 2 of the MFD's initial startup wizard. The Responder menu includes settings for STEDS specific features, which require an AIS5000 to be connected to the system.

Unit details

- *[Asset type]*— Select either *Vessel* or *Aircraft*.
- *[Unit type]*— Select unit type from the list.
- *[Unit name]*— Enter your unit name (this option is the same as the *[Boat name]* option available in the *[Boat details]* settings menu).

The unit type and asset type settings will synchronize and set the same values on a STEDS compliant AIS transceiver e.g.: Raymarine's AIS 5000.

First responder

MMSI / AIS

- *[MMSI]*— Set your vessel's MMSI number.

Important:

- In the United States of America (USA), the MMSI and Static Data must be entered only by a Raymarine® dealer or other appropriately qualified installer of marine communications equipment for marine vessels. In the USA, the user is NOT authorized to do this.
- In Europe and other parts of the world outside of the United States of America, the MMSI can be set up by the user.
- For further details, refer to the relevant Telecommunications Regulatory Body for your region.

- *[AIS mode]*— Determines the transmit/receive mode of STEDS AIS hardware. For details see: [p.375 — First responder AIS modes](#)

STEDS passphrase

- *[Passphrase]*— Enter the designated passphrase your team / organization is using to transmit and receive STEDS messages.
- *[Clear passphrase]*— Deletes the entered passphrase.
- *[Passphrase auto-wipe]*— Passphrase expiry. Set the number of days before the passphrase is automatically deleted (the passphrase will be wiped at 00:00 UTC).

Data logging

- *[Data logging]*— Enables and disables Data logging.
- *[Logging interval]*— Time interval between recording data.
- *[Save to:]*— Select the card slot to use for Data logging.

Password protection

- *[Activate password lock]* / *[Deactivate password lock]*— When activated critical settings cannot be changed without entering the specified password.

Advanced

- The following Advanced setting can be accessed from the From the *[Advanced set-up]* menu:
 - **TOI OneShot settings** For details refer to: [p.373 — TOI OneShot settings](#)

- **FID and checksum settings** For details refer to:
[p.362 – STEDS messaging transmission FIDs and checksums](#)
- **NMEA 2000 messages** For details refer to:
[p.362 – NMEA 2000 messages](#)
- **Inbox message retention** For details refer to:
[p.386 – Inbox message retention](#)
- **Round patterns to nearest 0.1 nm** — Enabling *[Round patterns]* ensures that SAR patterns appear the same on both broadcaster and recipient MFDs. This setting is disabled by default.

Important: SAR patterns are broadcast at a 0.1 nm resolution. If you intend to broadcast a SAR pattern ensure that *[Round patterns]* is enabled before the SAR pattern is created.

- *[Operate in Secondary SMC behavior]*. For details refer to:
[p.362 – Act in secondary mode](#)

Act in secondary mode

If the MFD is not the primary system on the NMEA 2000 network that is being used for SMC searches, the MFD should be put into secondary mode.

In secondary mode the MFD will ignore SMC requests from other systems on the same NMEA 2000 network.

Secondary mode can be enabled from the *[Advanced set-up]* menu: *[Homescreen > Settings > Responder > Advanced set-up > Configure]*.

Enable the *[Operate in Secondary SMC behavior]* toggle switch.

If the toggle is not enabled then the MFD will receive SMC requests from other systems on the same NMEA 2000 network.

STEDS messaging transmission FIDs and checksums

The SITREP and Static data functional IDs (FIDs) and FID checksum validation can be enabled and disabled from the *[Advanced set-up]* menu. *[Homescreen > Settings > Responder > Advanced set-up > Configure]*

STEDS messages

The following transmission SITREP and Static data FIDs are available:

- *Tx FID 10 (SITREP)*
- *Tx FID 11 (Static data)*

- *Tx FID 56 (Legacy SITREP)*
- *Tx FID 57 (Legacy static data)*

Note:

FID 10 and FID 11 are enabled by default. FID 56 and FID 57 are disabled by default.

Checksum validation

Checksum validation is enabled by default but can be enabled and disabled from the *[Transmission checksums]* menu: *[Homescreen > Settings > Responder > Advanced set-up > Configure > Transmission checksums]*.

When enabled received FID's checksums are checked to validate messages.

Checksum validation is available for the following FIDs:

- *FID 3— PI message acknowledgement*
- *FID 4 — Target of interest — 15s*
- *FID 5 — Target of interest — 60s*
- *FID 6 — Target of interest — 180s*
- *FID 7 — Target of interest — 600s*
- *FID 8 — Target of interest — single*
- *FID 10 — Situation report (v0 and v1 supported when clear)*
- *FID 11 — Static data report (v0 and v1 supported when clear)*
- *FID 23 — Search pattern report (encrypted)*
- *FID 28 — Text message*

NMEA 2000 messages

Below is a list of NMEA 2000 PGNs that can be enabled and disabled from the *[Advanced set-up]* menu: *[Homescreen > Settings > Responder > Advanced set-up > Configure > NMEA 2000 Messages]*.

- *[Transmit PGN 130311 (environmental)]*
- *[Transmit PGN 130312 (temperature)]*
- *[Output true heading](PGN 127250)*
- *[Transmit PGN 127237 (heading track control)]*

- *[Output Rx SITREP as Class A]* (Converts received secure SITREP to Class A Position Report and transmits on NMEA 2000 PGN 129038)
- *[Output Rx Static Data as Class A]* (Converts received secure Static Data to Class A Static and Voyage and transmits on NMEA 2000 PGN 129794)
- *[Output Rx Legacy SITREP as Class A]* (Converts received legacy SITREP to Class A Position report and transmits on NMEA 2000 PGN 129038)
- *[Output Rx Legacy Static Data as Class A]* (Converts received legacy Static Data to Class A Static and Voyage and transmits on NMEA 2000 PGN 129794)

23.2 Lost depth alarm

MFDs configured using the First responder boating activity can constantly monitor the availability of depth data using the lost depth alarm..

If depth data becomes unavailable (i.e.: lost) then the lost depth alarm is triggered. If depth data is intermittent then the alarm will only be triggered once every 60 seconds. The alarm will be automatically dismissed when depth data becomes available again.



The lost depth alarm is disabled by default and can be enabled from the *[Alarms]* manager: *[Homescreen > Alarms > Settings > Lost depth alarm]*.

23.3 Heading and SOG Homescreen status

When either Heading or Speed Over Ground (SOG) data is not available then a relevant message is displayed in the top right corner of the Homescreen under the GNSS (GPS) status..

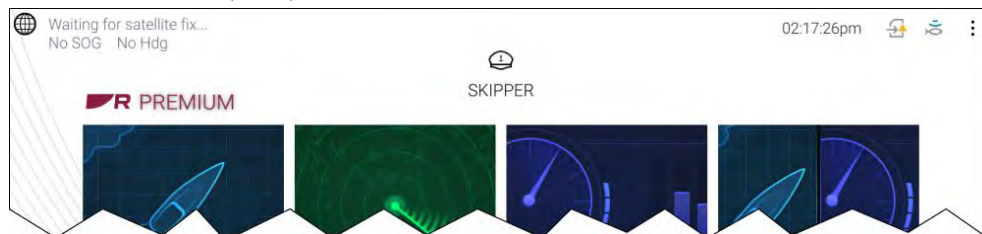

First responder

- **No SOG** is displayed if no source for SOG data is available.
- **No Hdg** is displayed if no source of heading data is available.

23.4 Settings password protection

Critical settings can be password protected to prevent them from being changed inadvertently.

The settings password lock is activated from the Responder settings tab menu: *[Homescreen > Settings > Responder]*.

Important:

If the password is forgotten the MFD will require a Power on reset to remove the password. Refer to: [p.520 – Performing a power on reset on an Axiom® Pro display](#)

If password protection has been activated the following settings cannot be changed without first entering the password:

Depth transducer settings

The settings determining where depth readings are taken from and, if applicable, the associated depth offset value, located in the Fishfinder app settings menu: *[Fishfinder > Settings > Transducer]*.

Wireless connection settings

The following settings located in the *[This display]* menu: *[Homescreen > Settings > This display]*.

- *[Wireless display]*
- *[Allow devices to connect via Wi-Fi]*
- *[Pair with Quantum]*.
- *[Settings reset]*
- *[Factory reset]*
- *[Bluetooth settings]*

Boat details settings

The following settings located in the Boat detail menu: *[Homescreen > Settings > Boat details]*

- *[Min safe height]*
- *[Min safe width]*
- *[Min safe depth]*
- *[Boat length]*
- *[Bow to GPS]*

Homescreen settings

The following settings accessed from the Homescreen:

- *[Bluetooth settings]*— accessed from the status area.
- *[Wi-Fi connection]*— accessed -from the third-party *[Apps]* page.
- *[Homescreen app page pop-over]*— accessed by pressing and holding on a blank space or app page icon.

23.5 Data logging

The Data Logger records, at regular intervals, readings taken by your vessel's equipment, an active Man overboard alarm, and the 5 closest AIS targets.

The Data logger is enabled by default and records data to a CSV file saved to a MicroSD card inserted into a card slot on the MFD. A new CSV file is created every hour up to a maximum of 73 files (72 hours of data), after which the first file will be overwritten by the next new Data logging file.

If the MicroSD card is removed or reaches capacity, Data logging will be suspended and a notification will be displayed onscreen.

Note:

- On MFD networks only the datamaster MFD can be used to perform data logging.
- For optimal performance, Do NOT use cartography cards for Data logging.

The status of the Data logger is displayed in the status area of the Homescreen using icons.

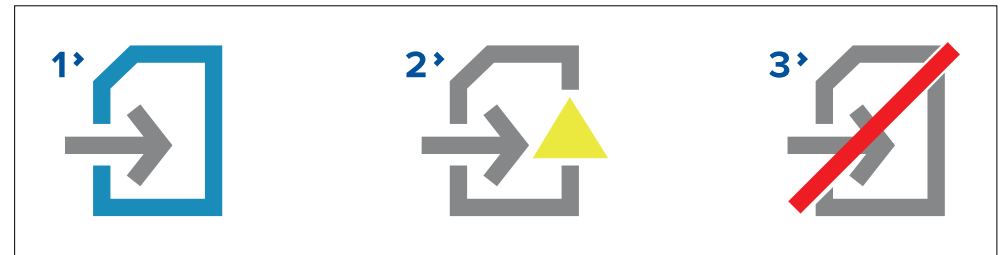

1. Data logging active
2. Data logging error (e.g.: no MicroSD card inserted)
3. Data logging disabled

The Data logger records the following data, when available:

Own vessel:

- Date and time
- Latitude and Longitude
- Heading
- Speed (SOG)
- Depth

Man Overboard:

- Latitude and Longitude
- Elapsed time

5 closest AIS targets:

- Vessel name
- Vessel MMSI
- Latitude and Longitude
- Heading
- Speed (SOG)

The Data logger can be configured from the *[Responder]* settings menu: *[Homescreen > Settings > Responder]*.

23.6 Waypoint at Range and Bearing from location

If an intelligence report is received that provides a target's range and bearing from the reporter's location a waypoint can be created using the reported details.

The waypoint can be placed in the Chart app by opening the Chart context menu at the location given and selecting *[more options]* and then *[Place Wpt at Rng/Brg]* to open the Waypoint dialog.

Screenshot of chart context menu and new waypoint dialog

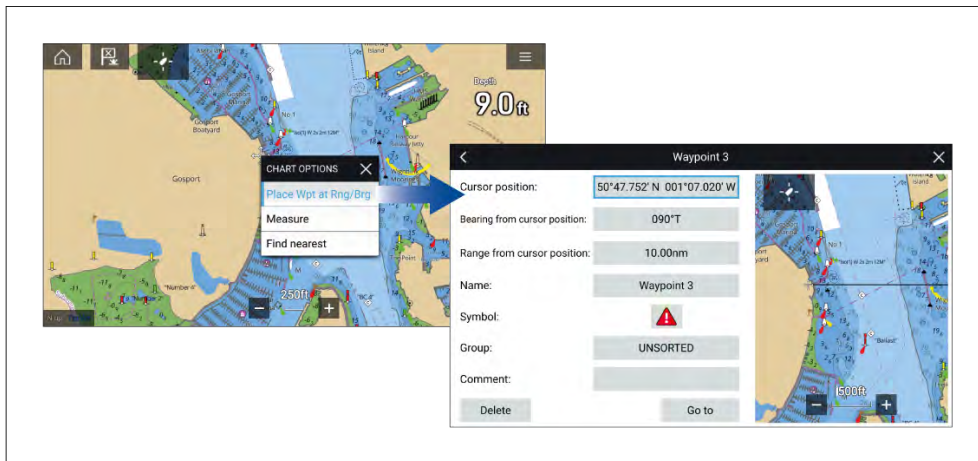

As a minimum the following fields are required to create the waypoint:

- *[Cursor position]* — Enter the reporter's coordinates
- *[Bearing from cursor position]* — Enter the reported target's Bearing
- *[Range from cursor position]* — Enter the reported target's Range

The following additional fields can be completed, if required:

- *[Name]* — Give the Waypoint a name
- *[Symbol]* — Change the default Waypoint symbol.
- *[Group]* — Assign the Waypoint to a Waypoint group.
- *[Comments]* — Add any additional details.

To finalize the waypoint creation select *[Back]* or *[Close]* the dialogue.

From the Waypoint from range and bearing dialogue you can also *[Delete]* the Waypoint if you do not want to keep it, or initiate a *[Goto]*.

23.7 Route sending and receiving

When the display has been configured using the *[First responder]* activity and the system includes a STEDs compatible AIS transceiver, routes can be sent and received.

Note:

- **Broadcast routes** — can contain a maximum of 7 waypoints. Broadcast routes with more than 7 waypoints cannot be sent.
- **Direct routes** — can contain a maximum of 5 waypoints. Direct message routes with more than 5 waypoints cannot be sent.
- **Receiving routes** — Routes containing up to 14 waypoints can be received by the system.
- **Forwarding routes** — Received routes can be forwarded. Routes with up to 5 waypoints can be forwarded as a *[Direct message]* route. Routes with up to 7 waypoints can be forwarded as a *[Broadcast]* route. Routes with more than 7 waypoints cannot be forwarded.

Once a route is created it can be *[Broadcast]* or sent as a *[Direct message]*. A *[Broadcast]* route will be received by all vessels that are using the same STEDs passphrase as the sending vessel. A *[Direct message]* will be sent to an individual vessel.

The *[Send route]* option is available from the *[Route]* context menu and from the *[Route list]* pop-over menu.

When a route is sent it will be received as a message which will be available in the Messages inbox.

Broadcasting a route

A route can be broadcast to all vessels using the same STEDs passphrase.

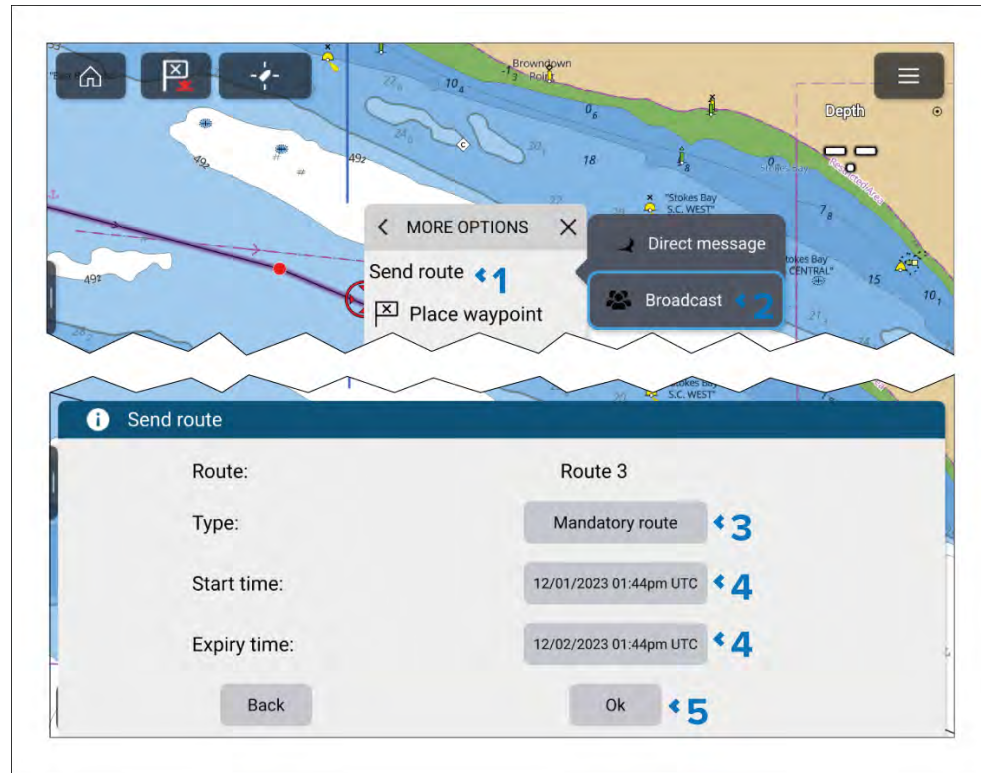

1. Select *[Send route]* from either the *[Route]* context menu or from the *[Route list]* pop-over menu.

To access the [Send route] option from the context menu, open the [Route] context menu and select [More options].

2. Select *[Broadcast]*.
3. Select the *[Type]* field and choose the relevant route type.
4. If required, adjust the *[Start time]* and *[Expiry time]*.

*For details, refer to:
[p.367 – Adjusting Start time and Expiry time for routes](#)*

5. Select *[OK]*.

The route will be broadcast to all vessels in range which have the same STEDs passphrase as the sending vessel.

Sending a route using direct message

A route can be sent to an individual vessel using its MMSI number, a vessel that is in your buddy list or to a vessel in the local vicinity.

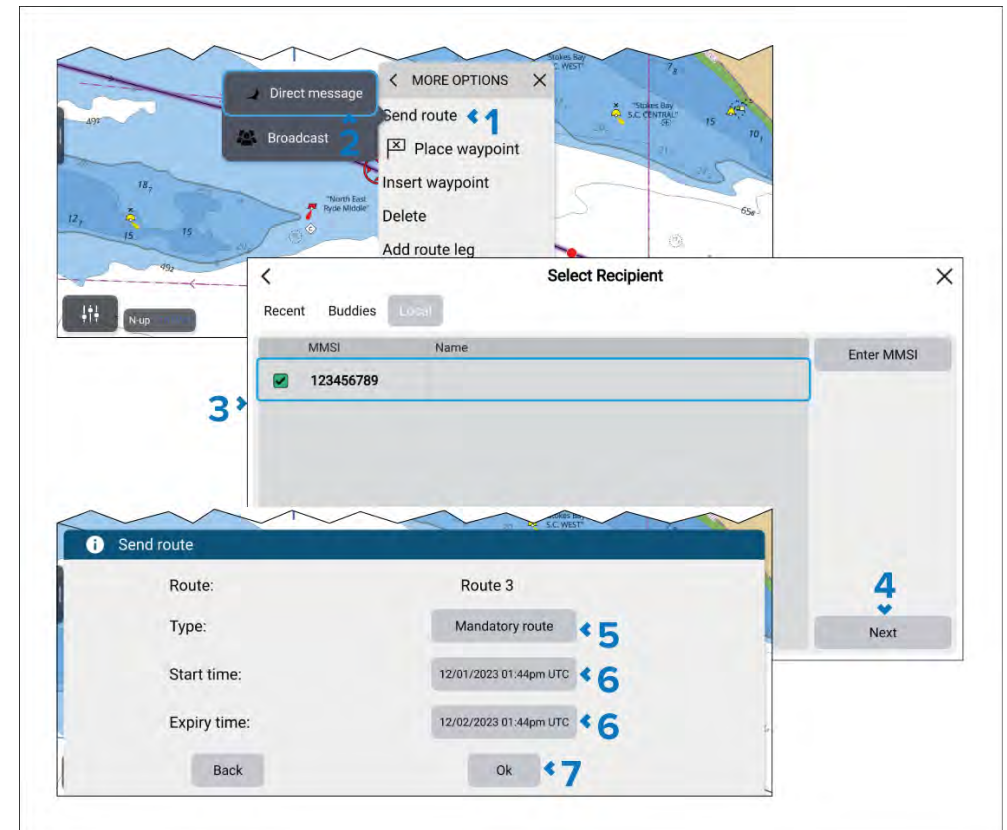

1. Select *[Send route]* from either the route context menu or from the route list pop-over menu.

To access the [Send route] option from the context menu open the route context menu and select [More options].

2. Select *[Direct message]*.
3. Select a contact from the *[Recent]*, *[Buddies]* or *[Local]* recipients list, or select *[Enter MMSI]* and enter the vessel's MMSI number.

4. Select *[Next]*.
5. Select the *[Type]* field and choose the relevant route type.
6. If required, adjust the *[Start time]* and *[Expiry time]*.

For details refer to:

[p.367 – Adjusting Start time and Expiry time for routes](#)

7. Select *[OK]*.

The route will be sent to the selected contact/MMSI.

Adjusting Start time and Expiry time for routes

When broadcasting or sending a route via a direct message, the *[Start time]* and *[Expiry time]* can be adjusted.

By default, the *[Start time]* will be the current system data and time.

By default, the *[Expiry time]* will be 24 hours **later than** the current system date and time.

1. Select *[Start time]*.

2. Use the *[Up]* and *[Down]* arrows to adjust the start date and time.
3. Select *[OK]*.

First responder

4. Select *[Expiry time]*.

5. Use the *[Up]* and *[Down]* arrows to adjust the expiry date and time.
6. Alternatively, select *[Duration]* and adjust the duration before the route will expire.
7. Select *[OK]*.

Once the expiry time is reached, “Expired” will be displayed against the Route in the Routes list, for both the sender and recipients of the route.

Receiving a route

A message notification is displayed onscreen when a route is received.

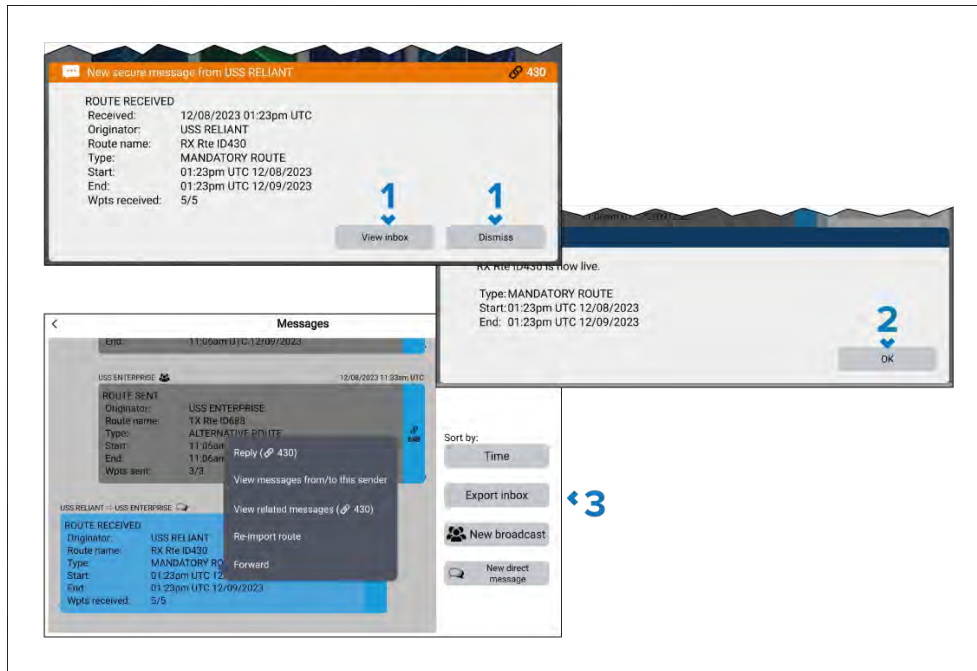

1. Selected either *[Dismiss]* or *[View inbox]*.
2. Select *[OK]* on the Route received info dialog.
3. If you selected *[View inbox]* then the Messages inbox will be displayed.

The received route will be available in the Chart app and will be listed in the *[All routes]* and *[Received routes]* lists.

Following a received route

Once a route has been received it can be followed in the same way as any other route.

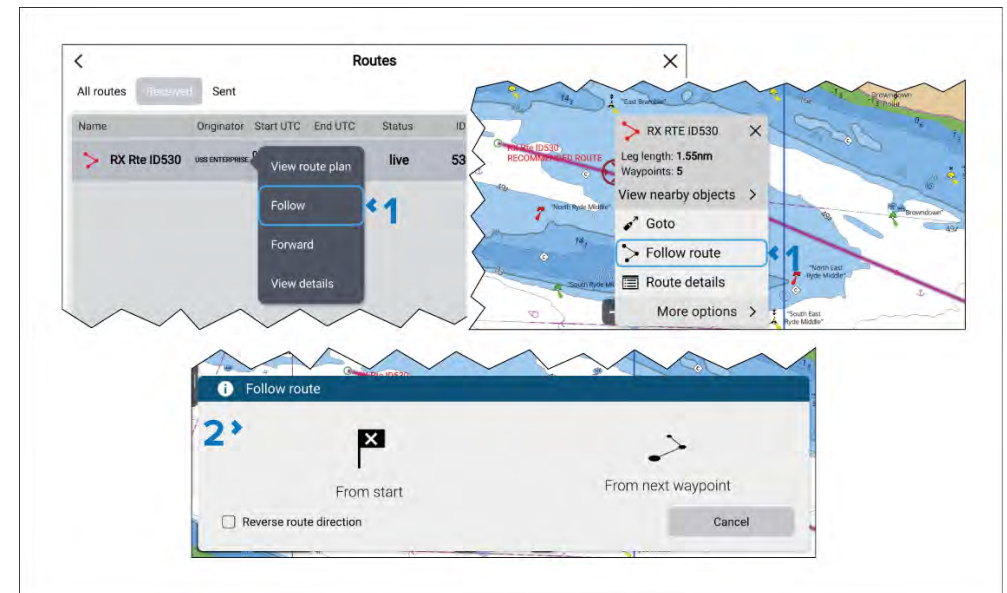

1. Select *[Follow route]* from the Route context menu, or select *[Follow]* from the Route's pop-over menu in the *[Received]* routes list.
2. Select how you wish to follow the route.

Active navigation of the route will commence.

Cancelling a sent route

Sent routes can be cancelled by the sending vessel.

The sent route can be cancelled from the Routes list. The routes list can be accessed from:

- *[Homescreen > My Data > Routes]*, or
- *[Chart app > Menu > Waypoints, Routes and Tracks > Routes]*

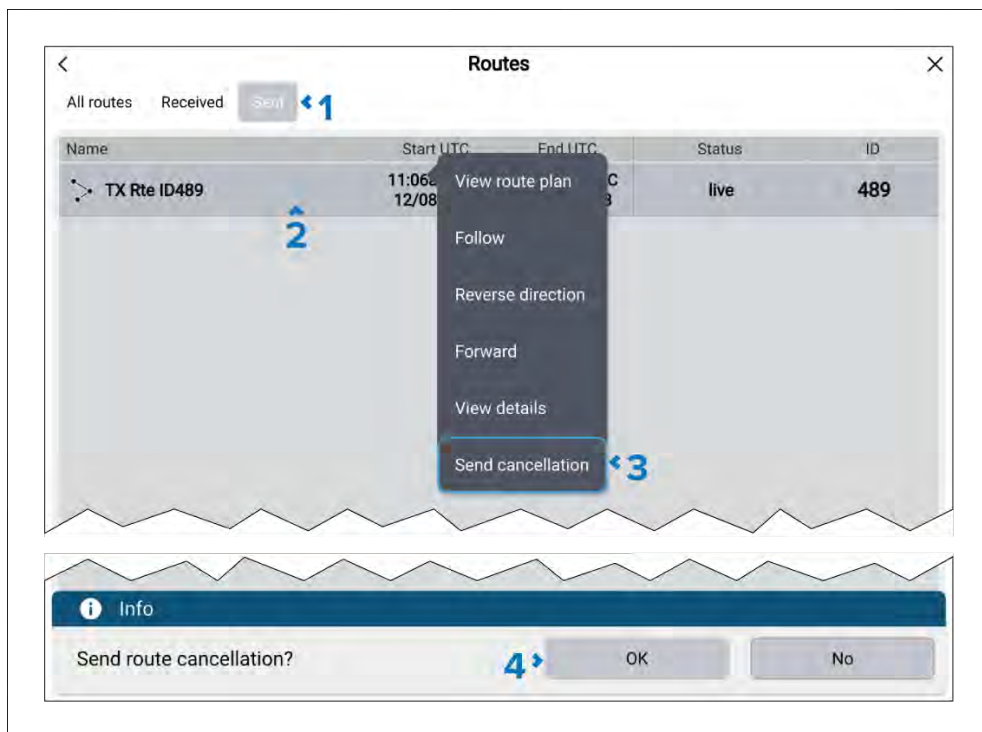

1. Select the *[Sent]* tab.
2. Select the sent route.
3. Select *[Send cancellation]* from the pop-over menu.
4. Select *[OK]* on the confirmation dialog.

A route cancellation message will be received by the recipient vessel(s), and the route's status will be set to Cancelled.

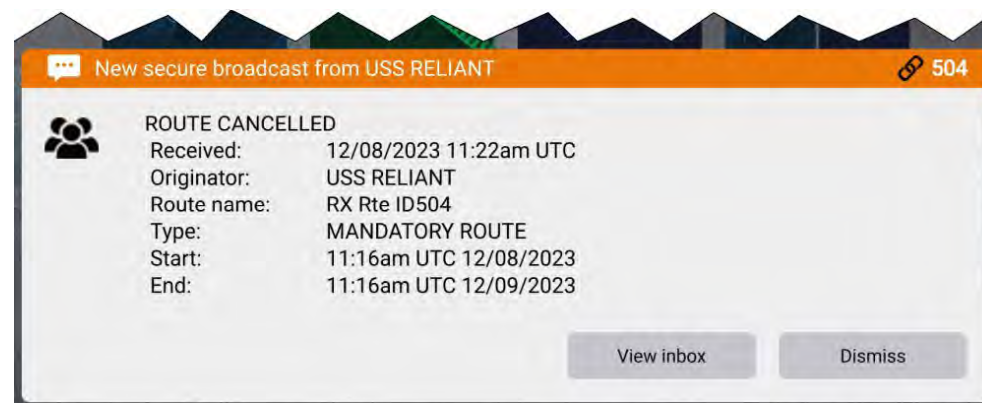

23.8 Intel targets

Intel targets are targets created manually based on visual or reported information of a vessel's position and if available, course and speed.

Intel targets are listed in the Intel targets list and an icon is used in the Chart app to represent the target.

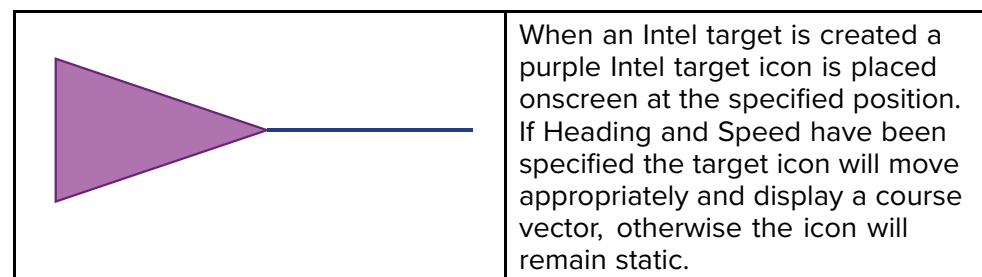

When an Intel target is created a purple Intel target icon is placed onscreen at the specified position. If Heading and Speed have been specified the target icon will move appropriately and display a course vector, otherwise the icon will remain static.

Intel targets will remain on the system until cancelled.

Creating an Intel target

Targets can be created using reported or sighted information about a target's location, Heading and Speed.

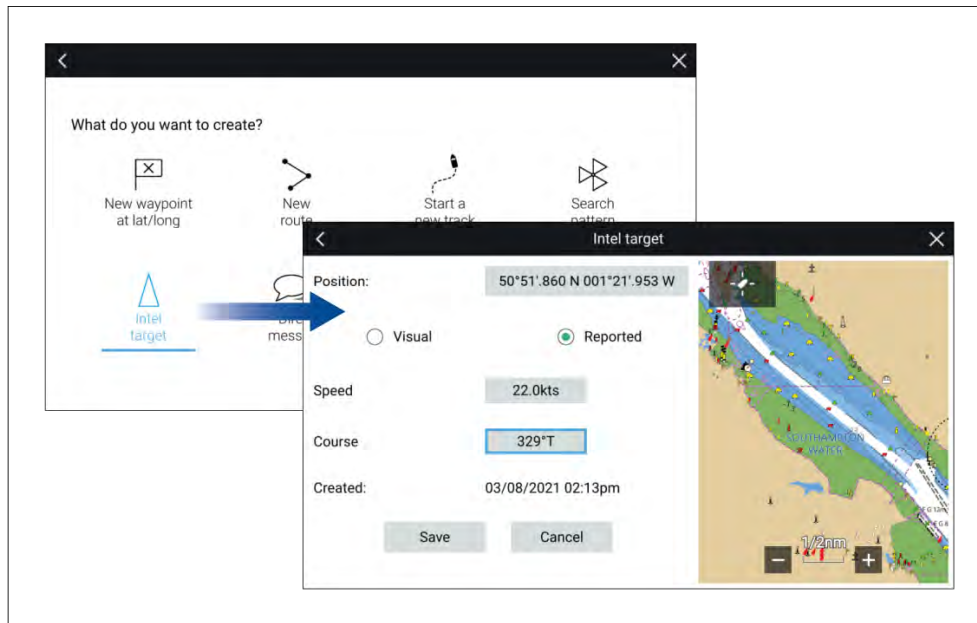

Intel targets are created from the Chart app's *[New]* menu: *[Menu > New > Intel target]*

To create an Intel target follow the steps below:

1. Place the cursor at the desired location in the Chart app.
2. Select *[New]* from the Chart app menu.
3. Select *[Intel target]*.
4. Ensure that the latitude and longitude for the target are correct in the *[Position]* field, adjusting if necessary.
5. Select whether the Intel is *[Visual]* or *[Reported]*.
6. Enter a *[Speed]* and *[Course]* for the Intel target.
7. Select *[Save]*.

The Intel target will be displayed in the Chart app using a purple target icon.

Intel targets can also be created from the Pop-over options in the Intel targets list: *[Menu > Targets > Intel > New intel target]*.

Accessing target options

Target specific options are available for targets that are currently being tracked. The target options can be accessed from the target's context menu and from the Pop-over options in the relevant target list. The options available are dependent on the type of target.

To access a target's context menu:

- Press and hold on the target onscreen, or
- Highlight the target onscreen using the *[Direction controls]* and press the *[OK]* button.

To access the target list Pop-over menu:

- Select the target in the relevant target list, or
- Highlight the target in the list using the *[Direction controls]* and press the *[OK]* button.

Intel target options

The following options are available for Intel targets.

- *[Designate TOI]* — If your MFD is configured for STEDS you can designate a target as a Target of Interest (TOI). For details see: [p.372 — Target Of Interest \(TOI\)](#)
- *[Cancel Target]* — Cancels the Intel target and removes it from the system.
- *[Intercept]* — Initiates a Target interception . For details see: [p.238 — Target intercept](#)
- *[Show on chart]* — Displays the target centered in the Chart app.

Intel target list

The target list identifies the target position, course, speed and the type of intel the target is based on (i.e.: Visual or Reported.). If the target has been designated as a TOI then the related Link ID will also be displayed.

The Intel targets list can be accessed from the Targets menu in the Radar app and Chart app: *[Menu > Targets > Intel]*.

Selecting a target from the list highlights the selected target in the LiveView app pane on the right of the page and opens the Pop-over menu.

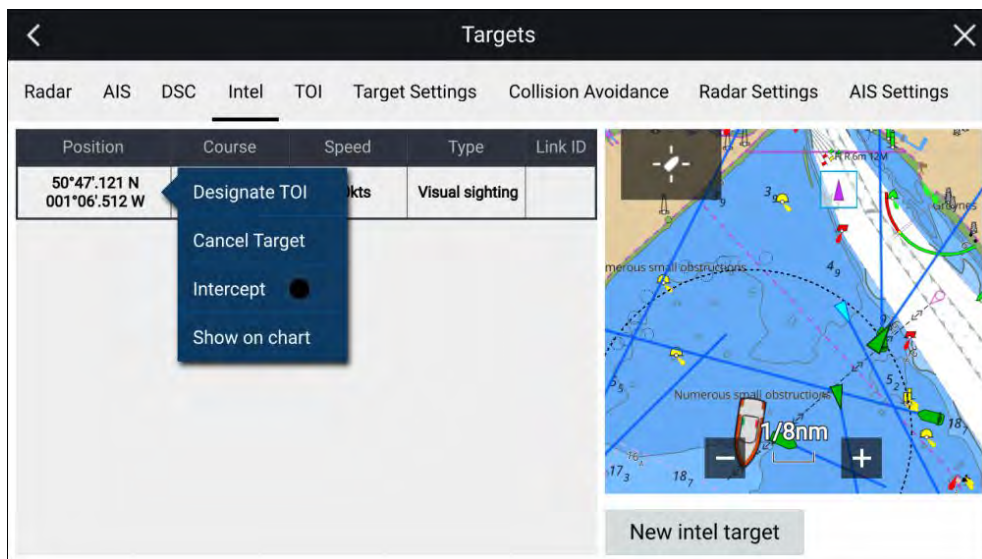

23.9 DSC targets

Waypoints created from DSC notifications will be displayed in the DSC target list and are displayed onscreen at the originating vessel's reported position.

For details on creating a waypoint from a DSC notification see: [p.132 — DSC distress notification](#)

DSC target symbols are static and remain in the reported position, however if a DSC position update is received a new DSC waypoint symbol can be placed at the new location.

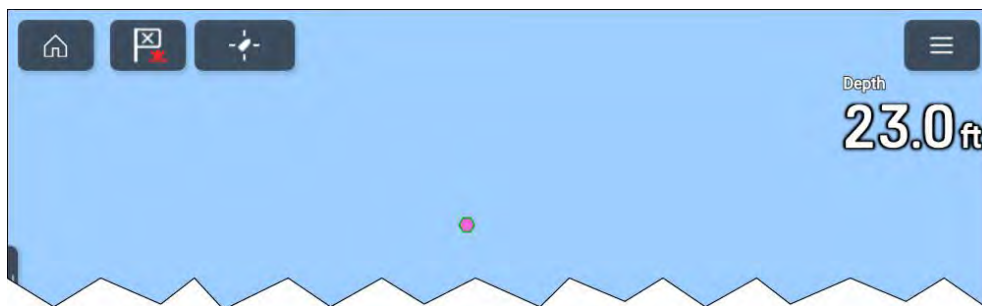

DSC targets will remain on the system until cancelled manually.

Accessing target options

Target specific options are available for targets that are currently being tracked. The target options can be accessed from the target's context menu and from the Pop-over options in the relevant target list. The options available are dependent on the type of target.

To access a target's context menu:

- Press and hold on the target onscreen, or
- Highlight the target onscreen using the *[Direction controls]* and press the *[OK]* button.

To access the target list Pop-over menu:

- Select the target in the relevant target list, or
- Highlight the target in the list using the *[Direction controls]* and press the *[OK]* button.

DSC target options

The following options are available for DSC targets.

- *[Designate TOI]* — If your MFD is configured for STEDS you can designate a target as a Target of Interest (TOI). For details see: [p.372 — Target Of Interest \(TOI\)](#)
- *[Cancel Target]* — Cancels the DSC target and removes the DSC waypoint from the system.
- *[Intercept]* — Initiates a Target interception . For details see: [p.238 — Target intercept](#)
- *[Goto]* — Initiate navigation to the target position.
- *[Show on chart]* — Displays the target centered in the Chart app.

DSC target list

The target list identifies: The MMSI number of the originating vessel, its reported Position, Range and Bearing from your vessel and the Type of distress. If the target has been designated as a TOI then the related Link ID will also be displayed.

The DSC target list can be accessed from the Targets menu in the Radar app and Chart app: *[Menu > Targets > DSC]*

Selecting a target from the list highlights the selected target in the LiveView app pane on the right of the page and opens the Pop-over menu.

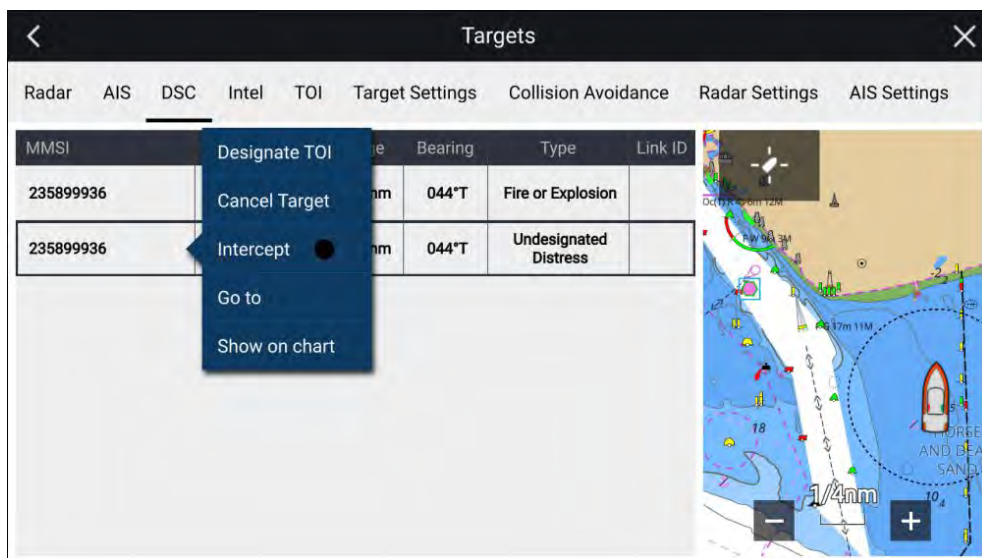

23.10 Target Of Interest (TOI)

AIS, Radar, DSC and Intel targets can be designated as TOIs. Once a target is designated as a TOI, STEDS messaging is used to broadcast the TOI to all vessels in range or to send the TOI to an individual MMSI number. TOIs can also be received over STEDS messaging.

Important:

Recipient MFDs must have the same STEDS passphrase installed as the sender's MFD.

TOIs can be assigned as 'OneShot' TOIs or as recurring TOIs. OneShot TOIs are sent once and are automatically cancelled after a specified decay period. Recurring TOIs are repeated until cancelled at the selected transmission rate.

TOIs created from Inter targets or DSC targets are always assigned as OneShot TOIs.

TOI icons are displayed in the Chart app and Radar app. Different icons are used to differentiate between sent and received TOIs.

	<p>Sent recurring TOI icon A recurring TOI is represented on the sender's MFD using a red triangle icon with 2 red rings around it. Recurring TOIs will be tracked until cancelled.</p>
	<p>Sent OneShot TOI icon A OneShot TOI is represented on the sender's MFD using a red triangle icon with 2 red dashed rings around it. OneShot TOIs will be tracked until the decay period has elapsed. See: p.373 – OneShot TOI decay times</p>
	<p>Received TOI icon A TOI that has been received from another vessel is represented on the recipient's MFD using a red triangle icon. When a TOI message is received a notification is displayed onscreen. The incoming message is saved in the <i>[Messages]</i> app. A TOI received from another vessel cannot be forwarded on to other vessels. Received TOIs will be tracked until cancelled.</p>

If a Radar target or AIS target that a TOI is based on becomes lost then the TOI will also become lost.

OneShot TOI decay times

TOIs designated as OneShot are temporary and are subject to a delay period before reverting to their original target states (i.e.: AIS target, Radar target, DSC target or Intel target).

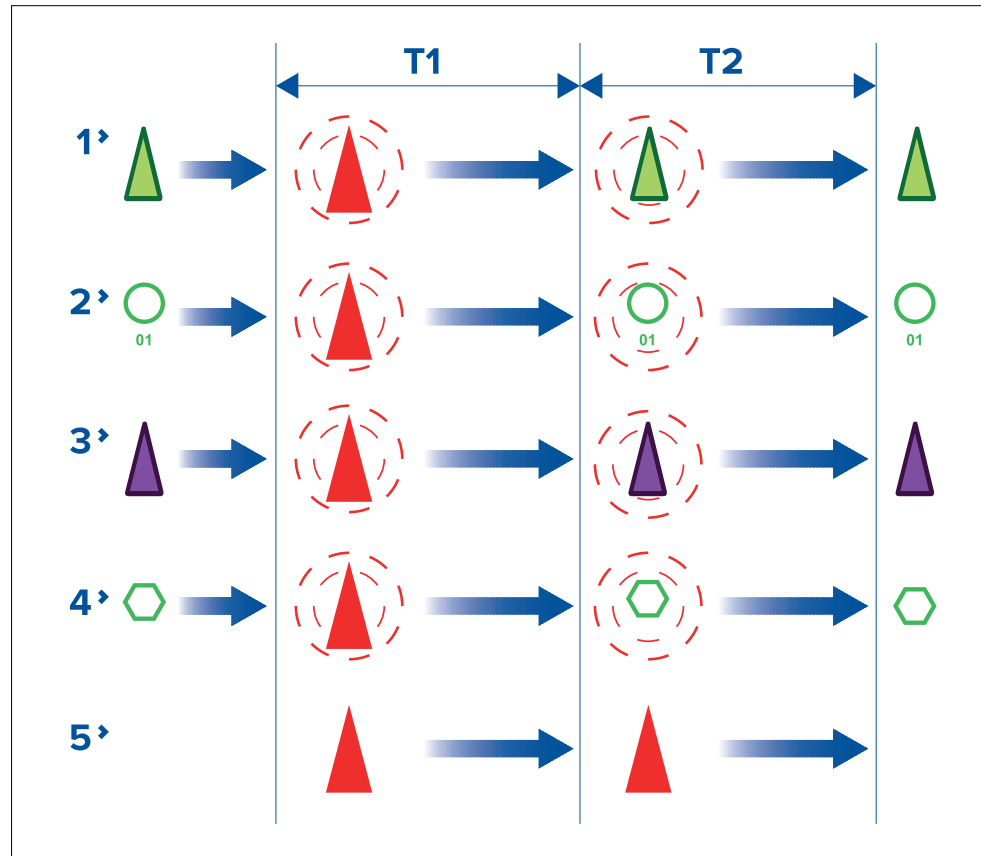

- **T1** Initial delay — The OneShot TOI icon is used to represent OneShot TOIs until an initial delay period has expired.
- **T2** Second delay — After the initial delay period has expired the TOI will revert to using its original target icon but maintain the Red dashed rings around the icon. After a second delay period expires the Red dashed circles are removed and the target reverts to using its original target icon. After the second delay period expires the target is no longer designated as a TOI.

1. AIS targets

First responder

2. Radar targets
3. Intel targets
4. DSC targets
5. Received TOI

Note:

Received OneShot TOIs use the standard received TOI icons for the duration of both delay periods and will then disappear.

TOI OneShot settings

TOI OneShot decay times and automatic repeat for sending / broadcasting the related STEDS message can be adjusted.

TOI OneShot settings are accessed from the *[Advanced set-up]* menu: *[Homescreen > Settings > Responder > Advanced set-up > Configure]*.

The following settings are available:

- *[T1]* — Number of seconds for the initial delay period.
- *[T2]* — Number of seconds for the second delay period.

TOI transmission rates

TOIs can be transmitted as either a single 'OneShot' transmission or as a recurring transmission.

TOIs generated from Intel targets or DSC targets are automatically assigned as OneShot TOIs. TOIs generated from AIS targets and Radar targets allow the sender to select the TOI rate when the TOI is created. Recipients and senders can change the TOI rate at anytime.

The following TOI rates can be selected:

- *OneShot (Single Transmission)* — TOI message is transmitted only once.
- *Slow Target (600 sec repeat)* — TOI message is transmitted every 600 seconds.
- *Medium Target (180 sec repeat)* — TOI message is transmitted every 180 seconds.
- *Fast Target (60 sec repeat)* — TOI message is transmitted every 60 seconds.
- *Aircraft Target (15 sec repeat)* — TOI message is transmitted every 15 seconds.

Note:

- A vessel can only send 1 recurring TOI message at a time. If a second recurring TOI message is sent out it will replace the first TOI message.
- A vessel can send out multiple OneShot TOI messages.
- A vessel can receive multiple OneShot and recurring TOI messages.
- TOI rates for Intel targets and DSC targets are always set as OneShot and cannot be changed.

TOI position updates

TOI positions are updated as follows:

- AIS targets and Radar targets will receive regular position updates from the relevant device.
- Intel targets will maintain their initially reported heading and speed
- DSC targets remain static, unless position reports are received.

Accessing target options

Target specific options are available for targets that are currently being tracked. The target options can be accessed from the target's context menu and from the Pop-over options in the relevant target list. The options available are dependent on the type of target.

To access a target's context menu:

- Press and hold on the target onscreen, or
- Highlight the target onscreen using the *[Direction controls]* and press the *[OK]* button.

To access the target list Pop-over menu:

- Select the target in the relevant target list, or
- Highlight the target in the list using the *[Direction controls]* and press the *[OK]* button.

TOI options

TOI options are available which change the status and details of a TOI. Changes to TOI options are sent and received over STEDS messaging.

Note:

Context menu options — In addition to the TOI options listed below, options relevant to the type of target the TOI originated from will also be available in the target context menu (i.e.: Radar, AIS, DSC or Intel).

- *[Cancel TOI]* — TOIs can be cancelled by selecting *[Cancel TOI]*.
 - Sent TOI — When a sender selects *[Cancel TOI]* the local TOI target icon will revert to its original target icon and the TOI is automatically cancelled for all recipients.
 - Received TOI — When a recipient selects *[Request TOI cancellation]* a cancellation request is sent to the originator and once acknowledged the TOI target icon will be removed or revert to its original target icon.
- *[TOI description]* — The type of vessel that the TOI target icon represents can be set or updated using the *[TOI description]* option. Changes are automatically updated for the sender and all recipients.
- *[TOI status]* — The status of the TOI can be set or updated using the *[TOI status]* option. Changes are automatically updated for the sender and all recipients.
- *[Intercept]* — Selecting *[Intercept]* initiates target interception for the selected target. For details see: [p.238 — Target intercept](#)
- *[Centre on chart]* — Selecting *[Centre on chart]* centres the TOI in the Chart app.
- *[View related messages]* — Selecting *[View related messages]* opens the STEDS messaging app and displays all related messages (messages that have the same link ID as the selected TOI).
- *[TOI rate]* — The rate of transmission can be changed for recurring TOIs by selecting *[TOI rate]* and then selecting the required rate.

Note: TOI rate for OneShot TOIs cannot be changed.

- *[Clear lost TOI]* — Selecting removes the TOI from the TOI list and either removes the TOI icon from the Chart app or reverts the target icon to its previous target icon.

TOI list

Targets currently designated as TOIs are listed in the TOI target list: The TOI list identifies: The Link ID created when the TOI was sent/broadcast. The Description, Originating vessel, Range and Bearing and the TOI status.

The TOI list can be accessed from the Targets menu in the Radar app and Chart app: *[Menu > Targets > TOI]*

Selecting a target from the list highlights the selected target in the LiveView app pane on the right of the page and opens the Pop-over menu.

TOI target list

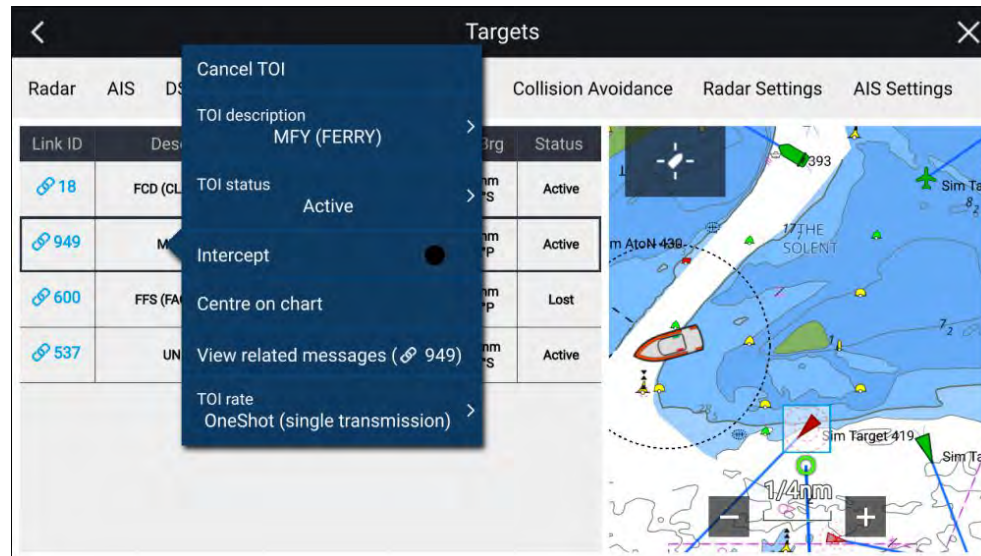

23.11 First responder AIS modes

With compatible STEDS AIS hardware connected the mode of the AIS hardware can be set from the MFD.

The AIS modes can be viewed and changed from the Status area in the Homescreen. Select the Status area and then select AIS to display and select available modes.

The AIS mode of the connected STEDs compatible AIS hardware will automatically be updated to match the selected mode.

First responder

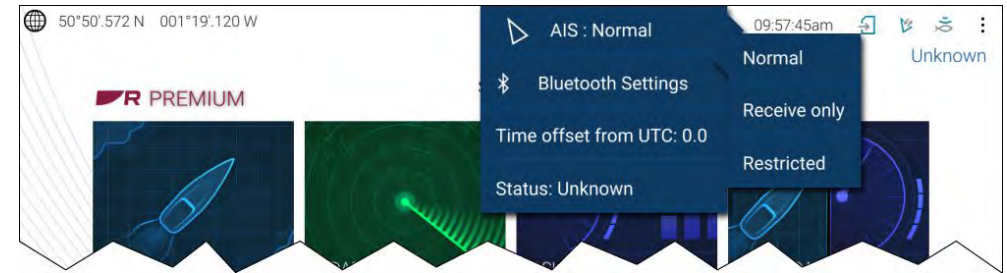

The following AIS modes are available:

- *[Normal]*— In this mode your AIS hardware will receive and transmit AIS messages and encrypted AIS messages.
- *[Receive only]*— In this mode your AIS hardware receives AIS messages and encrypted AIS messages, but transmits nothing (maintaining radio silence).
- *[Restricted]*— In this mode your AIS hardware will receive AIS messages and encrypted AIS messages, but only transmits encrypted AIS messages (no AIS messages are transmitted). This means vessels with 'standard' AIS receivers / transceivers will not be able to detect Blue Force vessels.

The AIS mode can also be changed from the *[AIS Settings]* menu: *[Menu > Targets > AIS Settings > AIS mode]* and from the Homescreen settings menu: *[Homescreen > Settings > Responder. [AIS mode]*

Note:

[AIS mode] replaces the *[Silent mode]* option available on non-STEDS First responder configurations.

AIS mode status icons

Status icons are displayed in the Homescreen status area which identify the current AIS mode in use.

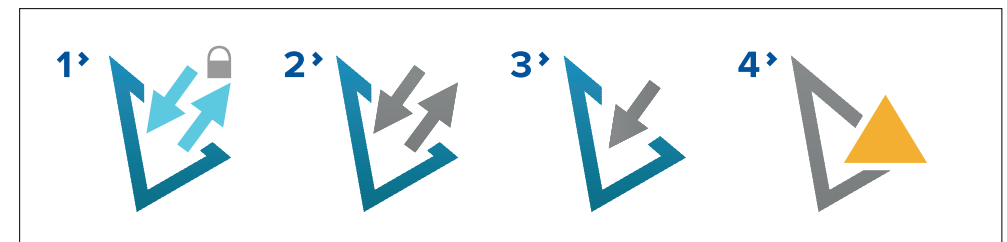



1. Restricted mode.

2. Normal mode.
3. Receive only mode.
4. Error.

Blue Force Tracking

Other vessels that are equipped with STEDS compatible AIS hardware, such as the AIS5000 are displayed onscreen using Blue Force AIS target icons.

The following icons are used:

	Blue Force vessel		Blue Force SAR
---	-------------------	---	----------------

The Blue Force icons are used as long as:

- your MFD has a matching First responder passphrase.
- you have received a SITREP from them within the last 6 minutes.
- their AIS mode is not set to Receive only.

If the above conditions are not met then the target icon will revert to using the standard, Green AIS target icon.

23.12 AIS high target alarm

When the MFD is configured using the 'First responder' activity, the AIS high target alarm is available which, when enabled, will trigger when the MFD approaches and also when it exceeds the maximum quantity of AIS targets that can be shown onscreen.

The AIS high target alarm is only triggered when either the Chart app or Radar app is open.

- When the AIS target count reaches 90, the alarm will warn that the MFD is approaching its maximum limit.
- When the AIS target count reaches 100, the alarm will warn that the MFD has exceeded its maximum limit.

When between 90 and 99 AIS targets are detected, *[High AIS]* is displayed in the bottom left corner of the Chart app and Radar app. When 100 or more AIS targets are detected, *[Max AIS]* is displayed.

The alarm can be enabled and disabled from the *[Alarms]* manager: *[Homescreen > Alarms > Settings > High/maximum AIS targets]*.

23.13 SITREP (Situation report)

SITREP status is transmitted and received over STEDS messaging so that other STEDS equipped vessels using the same STEDS passphrase can see your status and you can see their status.

The current SITREP status is displayed in the Status area of the Homescreen. The SITREP status can be changed by selecting *[Status:]* from the Status area Pop-over menu and then selecting a SITREP.

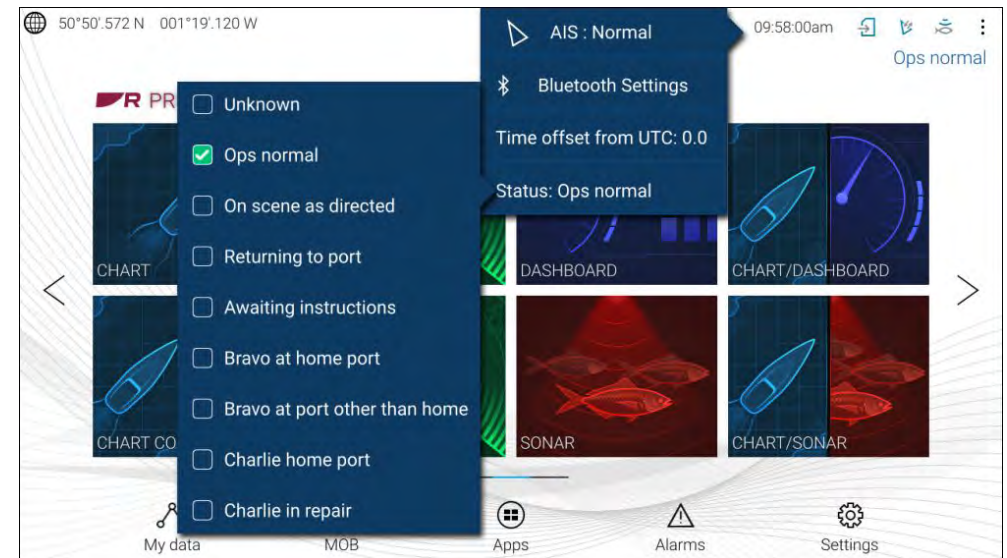

Note:

- SITREP status is transmitted every 15 seconds if a vessel is traveling at 3 knots or more.
- SITREP status is transmitted every 30 seconds if a vessel is traveling under 3 knots for more than 3 minutes.

The SITREP status of other vessels is displayed in the Blue Force Target's context menu in the Chart app and Radar app.

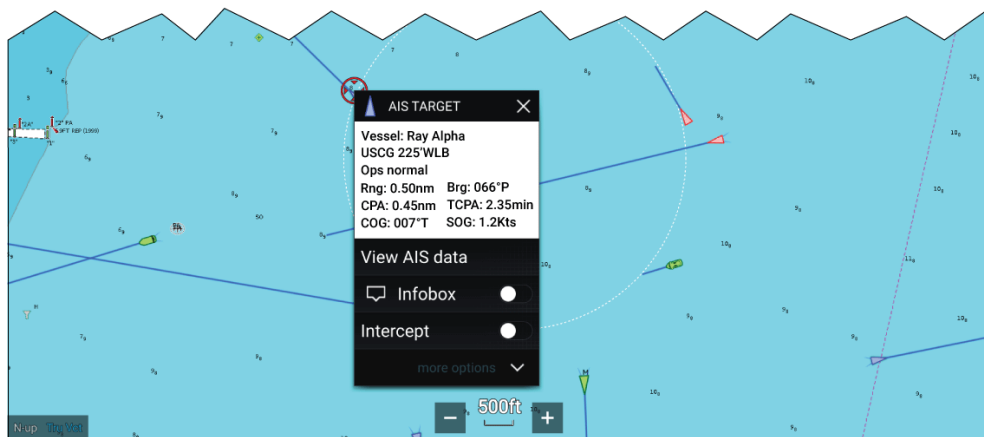

The MFD supports both current (FID 10) and legacy (FID 56) SITREPs.

Note:

- Blue Force targets using Legacy SITREP FID 56 are displayed using the Blue Force icons, however cannot be interacted with (i.e.: you cannot send or receive text messages, SAR patterns or TOIs).
- Blue Force targets using Legacy SITREP FID 56 can also be displayed when using an NMEA 0183 connection but cannot be interacted with.

23.14 First responder target context menus

When the display has been configured using the *[First responder]* activity extra data and options are available in AIS target and Radar target context menus.

The following additional data and options are provided for first responders:

Example AIS target context menu

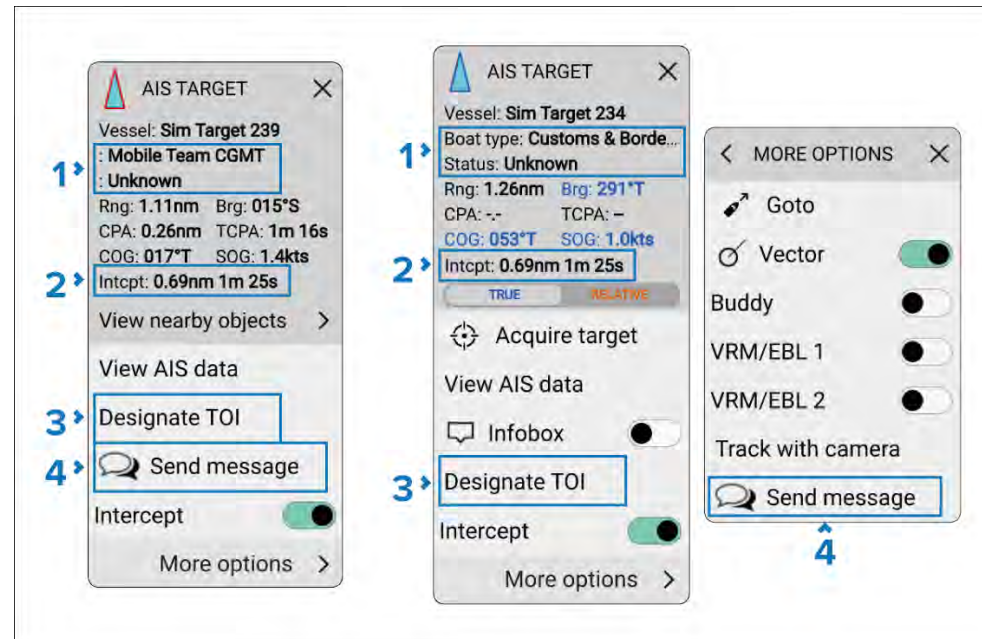

1. Boat type and status — Only available for AIS targets.
2. Intercept distance and time — Only available when *[Intercept]* is enabled.
3. *[Designate TOI]*
4. *[Send message]* — Only available for AIS targets.

23.15 Depth markers

Depth markers are visual indicators that can be placed in the sonar app at a specified depth. The marker will remain onscreen until removed.

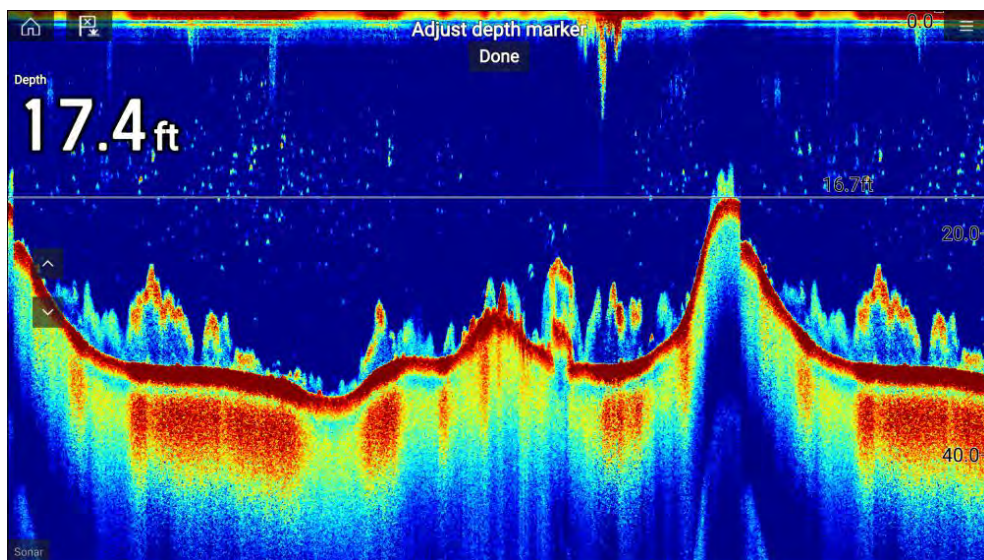

Placing a depth marker allows you to quickly identify objects in the water column at a certain depth.

Placing a depth marker

Follow the steps below to place a depth marker.

From the sonar app:

1. Select and hold an area onscreen.
2. Select *[Show depth marker]*.
3. Turn the uni-controller or use the uni-controller's joystick up and down to adjust the depth of the marker.
4. Select *[Done]* or press the *[OK]* button.

You can remove the depth marker by selecting anywhere onscreen and selecting *[Remove depth marker]* from the context menu or you can move the depth marker to a new location by selecting *[Move marker here]* from the context menu.

23.16 Import and export Waypoints and Routes over NMEA networks

Waypoints and Routes can be imported and exported over NMEA 0183 and NMEA 2000 (N2K) / SeaTalkng®

Note:

- Receiving waypoints and routes is subject to the waypoint and route capacity of your MFD. The transfer will fail if the MFD's capacity is reached during the transfer. For capacity limits refer to: [p.383 — Waypoint, routes and tracks capacity](#)
- It is recommended that importing and exporting waypoints over NMEA 0183 and NMEA 2000 is used for small batches of less than 150 waypoints. The preferred method for importing and exporting larger amounts of waypoint is via memory card transfer. Refer to: [p.106 — Import/export](#)

The import and export options are available from the Import/Export menu: *[Homescreen > My data > Import/Export > Import/export from network]*.

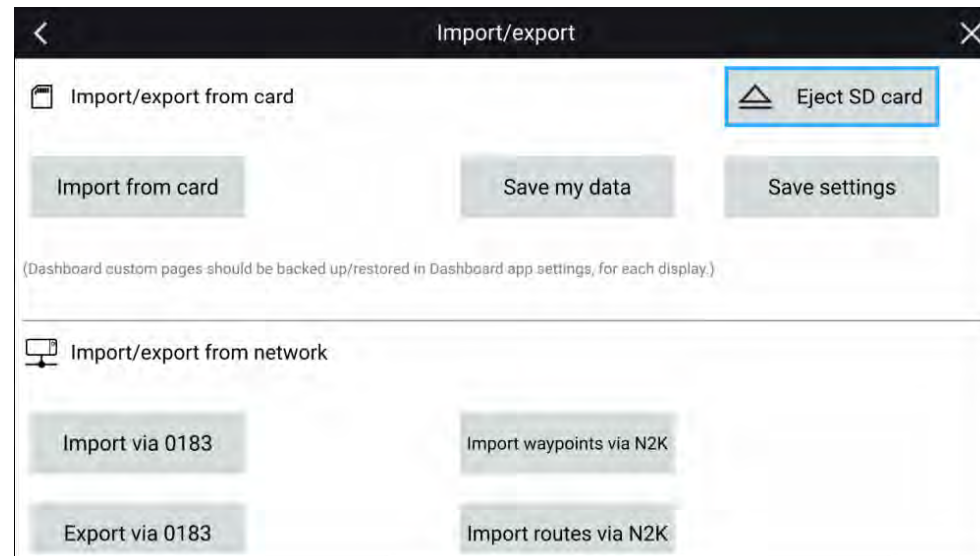

The *[Import waypoints via N2K]* and *[Import Routes via N2K]* options are only enabled when another compatible MFD is present on the NMEA 2000 / SeaTalkng® network.

The *[Import via 0183]* and *[Export via 0183]* options are always enabled and require interaction on the other MFD.

Importing Waypoints or Routes over NMEA 2000

Follow the steps below to Import Waypoints or Routes over an NMEA 2000 / SeaTalkng® network.

Note:

LightHouse 3 and LightHouse 4 MFDs allow more than 1 waypoint or route to have the same name. It is recommended that you check that the import will not create waypoints or routes with the same name and if necessary rename them before importing.

Example importing waypoints

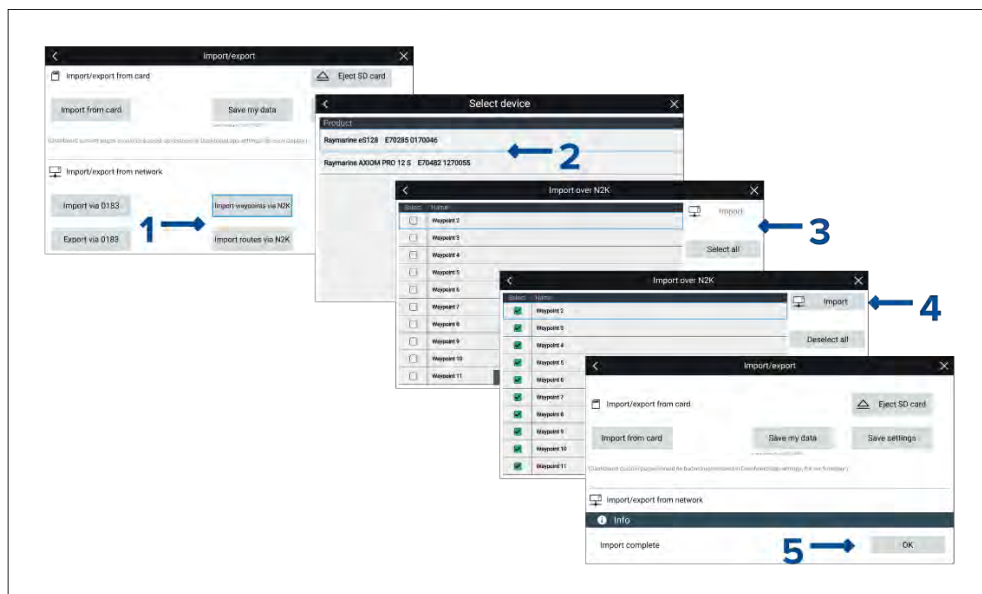

From the *[Import/export]* menu: *[Homescreen > My data > Import/export]*.

1. Select either *[Import waypoints via N2K]* or *[Import Routes via N2K]*.
2. Select the device from the list that has the waypoints or routes that you want to import.

Important:

If there is only 1 compatible device connected then this step will be skipped.

A list of Waypoints or Routes on the selected device will be displayed.

3. Select each waypoint or route that you want to import, or select *[Select all]*.
4. Select *[Import]*.
5. Select *[OK]* on the import confirmation dialog.

The selected waypoints or routes will now be available on the MFD.

Importing waypoints or routes over NMEA 0183

This procedure details importing waypoint or routes to an MFD running either the LightHouse 3 or LightHouse 4 operating system from an MFD running the First responder version of the LightHouse 2 operating system.

Note:

It may be possible to import waypoints and routes from other NMEA 0183 devices following a similar procedure, refer to the instructions that accompanied the NMEA 0183 device and use them in place of the LightHouse 2 steps below.

Note:

LightHouse 3 and LightHouse 4 MFDs allow more than 1 waypoint or route to have the same name. It is recommended that you check and rename waypoints or routes that have the same name as existing waypoints and routes before importing.

1. Ensure that an NMEA 0183 input port on the receiving MFD is correctly connected to an NMEA 0183 output port on the LightHouse 2 First responder MFD.

Example NMEA 0183 connection

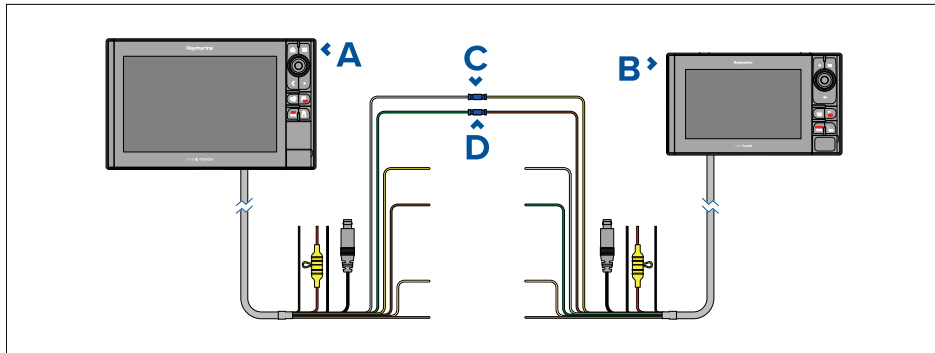

1. Receiving MFD (e.g.: Axiom Pro running LightHouse 3 / LightHouse 4)
2. LightHouse 2 MFD (e.g.: eS series)
3. Example connection Port 1, positive input (White) to Port 1, positive output (Yellow)
4. Example connection Port 1, negative input (Green) to Port 1, negative output (Brown)

Note:

If you require 2 way transfer of waypoint and routes also connect:

- Example connection Port 1, positive output (Yellow) to Port 1, positive input (White)
- Example connection Port 1, negative output (Brown) to Port 1, negative input (Green)

2. Select *[Import via 0183]* from the *[Import/Export]* menu: *[Homescreen > My data > Import/export]*.
The receiving MFD will be waiting to receive over NMEA 0183 connection.

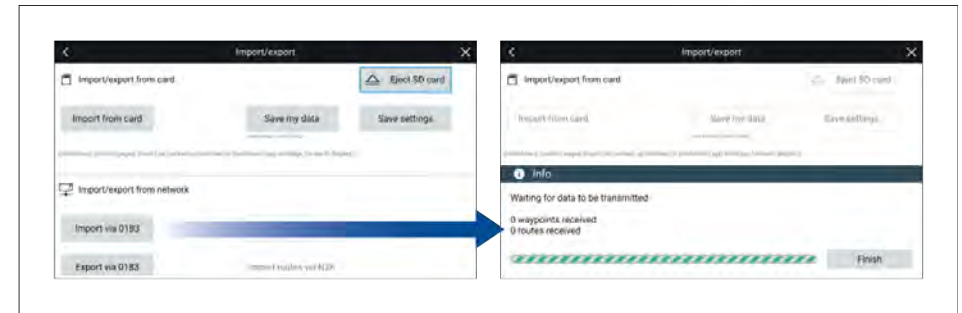

3. On the LightHouse 2 MFD:
 - i. Select *[My data]* from the Homescreen.
 - ii. Select either *[Waypoints]* or *[Routes]*.
 - iii. Select *[Import/Export]* from the top of the waypoint list / routes list.
 - iv. Select either *[Export Waypoints to Connected Device (0183)]* or *[Export Routes to Connected Device (0183)]*.
 - v. Select the Waypoints or the Routes you want to transfer.
 - vi. Select *[Send]*.

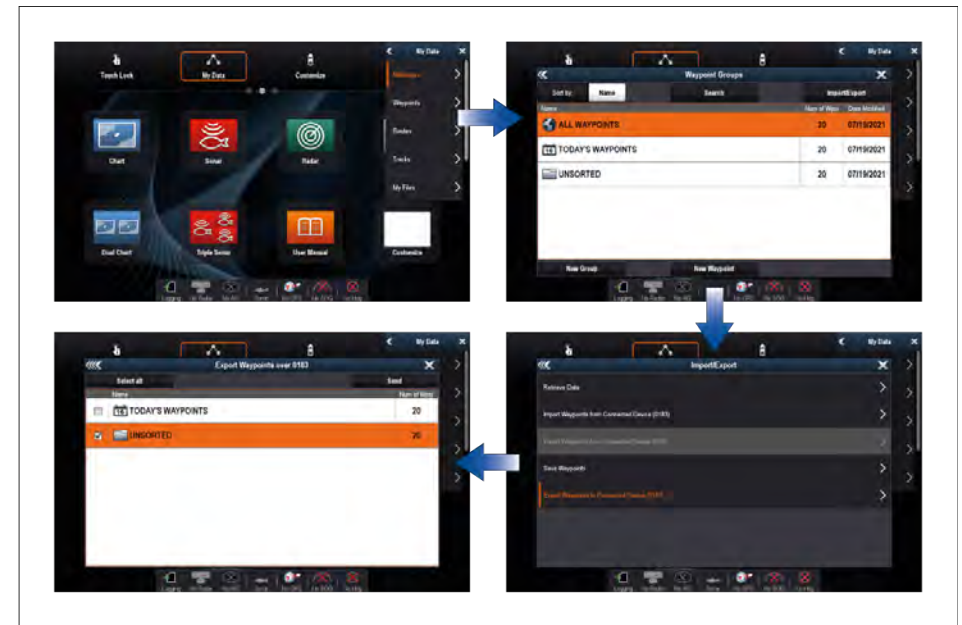

4. Back on the receiving MFD:
 - i. When all waypoints or routes have been received select *[Finish]*.

ii. Select *[OK]* on the Import complete dialog..

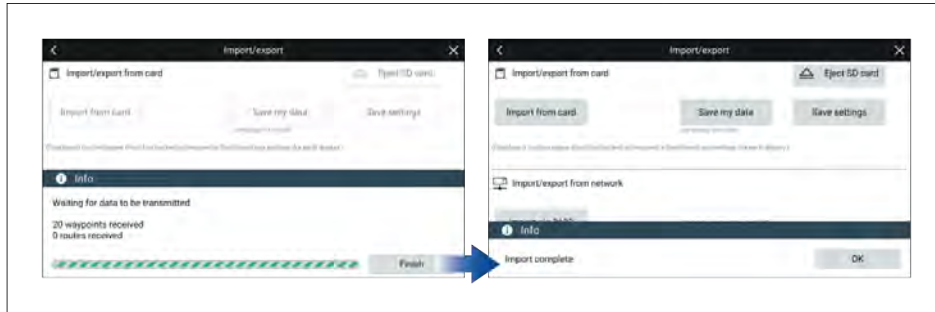

Exporting waypoints or routes over NMEA 0183

This procedure details exporting waypoints or routes from an MFD running the LightHouse 3 or LightHouse 4 operating system to an MFD running the First responder version of the LightHouse 2 operating system.

Note:

It may be possible to export waypoints and routes to other NMEA 0183 devices following a similar procedure, refer to the instructions that accompanied the NMEA 0183 device and use them in place of the LightHouse 2 steps below.

1. Ensure that an NMEA 0183 output port on the sending MFD is correctly connected to an NMEA 0183 input port on the LightHouse 2 First responder MFD.

Example NMEA 0183 connection

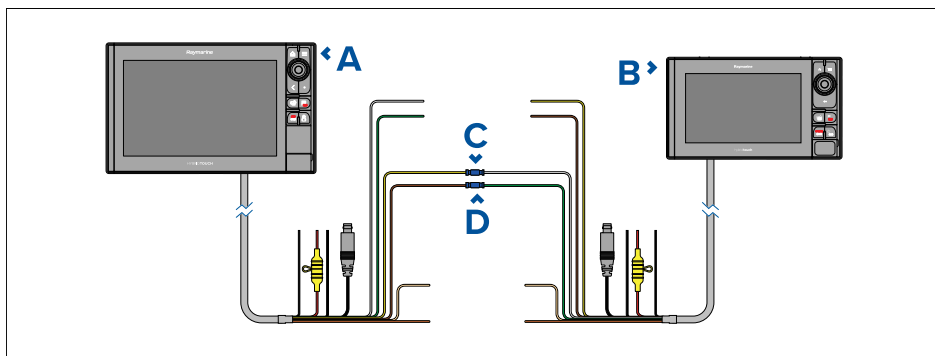

1. Sending MFD (e.g.: Axiom Pro running LightHouse 3 / LightHouse 4)
2. LightHouse 2 MFD (e.g.: eS series)
3. Example connection Port 1, positive output (Yellow) to Port 1, positive input (White)
4. Example connection Port 1, negative output (Brown) to Port 1, negative input (Green)

Note:

If you require 2 way transfer of waypoint and routes also connect:

- Example connection Port 1, positive input (White) to Port 1, positive output (Yellow)
- Example connection Port 1, negative input (Green) to Port 1, negative output (Brown)

2. Ensure the sending MFD's NMEA 0183 Transmission mode setting is set to *[Single-ended]*.

The Transmission mode settings is located on the NMEA set-up menu page: *[Homescreen > Settings > Network > NMEA set-up >]*

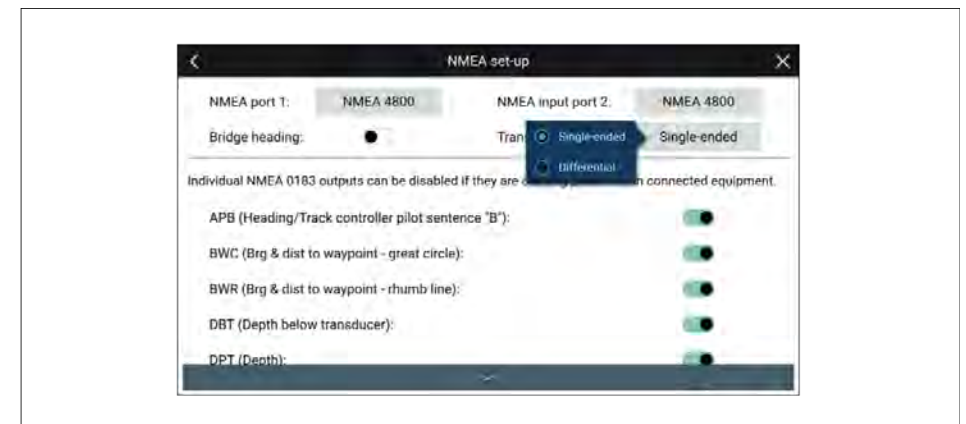

3. From the LightHouse 2 MFD:
 - i. Select *[My data]* from the *[Homescreen]*.
 - ii. Select either *[Waypoints]* or *[Routes]*.
 - iii. Select *[Import/Export]* from the top of the waypoint list / routes list.

- iv. Select either *[Import Waypoints from Connected Device (0183)]* or *[Import Routes from Connected Device (0183)]*.

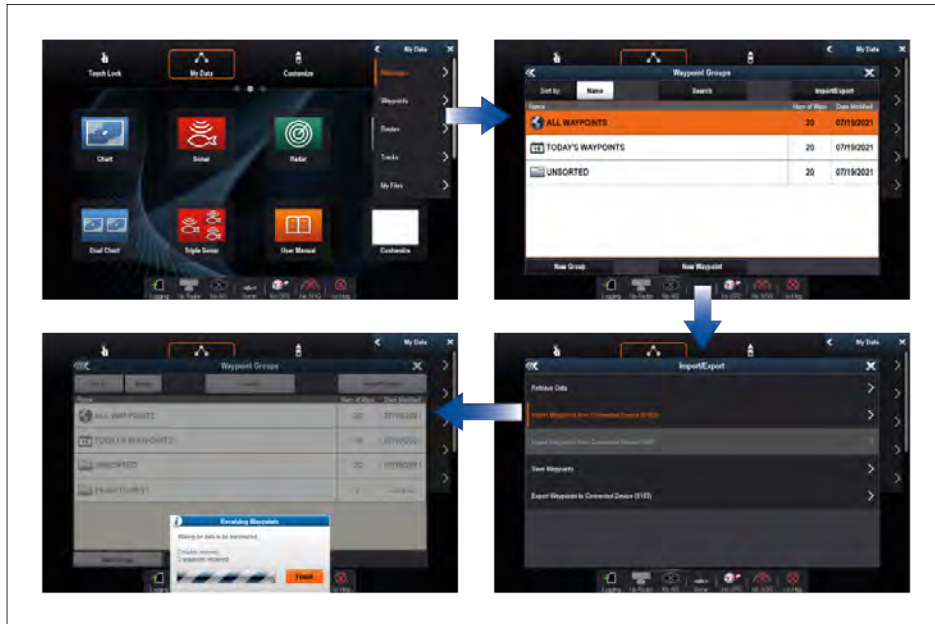

The LightHouse 2 MFD will be waiting to receive over NMEA 0183 connection.

4. From the sending MFD:
- i. Select *[Export via 0183]* from the Import/export menu: *[Homescreen > My data > Import/export]*.
 - ii. Select either *[Export waypoints]* or *[Export routes]*.
 - iii. Select the waypoints or the routes that you want to export.
 - iv. Select *[Export]*.

- v. Select *[OK]* on the export complete dialog.

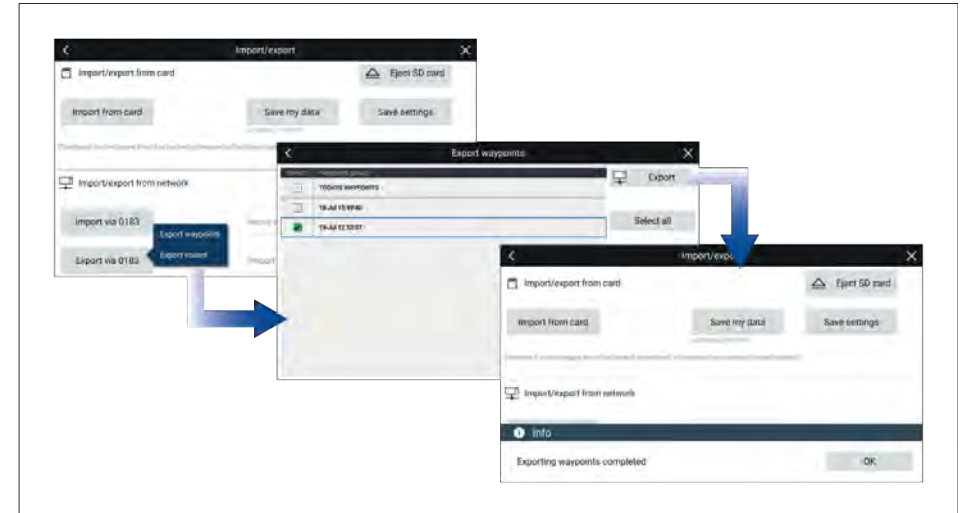

5. From the LightHouse 2 MFD:
- i. LightHouse 2 MFDs do not allow more than 1 waypoint or routes to have the same name. If the MFD detects a waypoint or route with a name that conflicts with a waypoint or route already in the system the following options are displayed:
 - *[Copy as new waypoint] / [Copy as new route]*— renames the waypoint / routes and imports it.
 - *[Copy & Replace]*— replaces the existing waypoint or route with the new one.
 - *[Don't copy]*— Keeps the existing waypoint or route and does not import the new one.
 - ii. When all waypoints or routes have been received select *[Finish]*.



Waypoint, routes and tracks capacity

Waypoints, routes and tracks are subject to capacity limits. The capacity limits for LightHouse™ 3 MFDs is shown below

- **Waypoints** — Your MFD can store up to 10,000 waypoints which can be sorted into up to 200 waypoint groups
- **Routes** — Your MFD can store up to 250 routes, each route consisting of up to 500 waypoints. The route capacity limit is subject to your MFD's 10,000 Waypoint limit (for example, your MFD could store 20 routes each containing 500 waypoints)
- **Tracks** — Your MFD can store up to 15 tracks, each track can contain up to 10,000 points.

CHAPTER 24: MESSAGING APP

CHAPTER CONTENTS

- [24.1 Messaging app](#) — page 385

24.1 Messaging app

MFDs configured with a STEDs-compliant AIS transceiver can send and receive information with other STEDs-equipped vessels using the messaging app.

The following types of information can be sent and received:

- Text messages
- Targets Of Interest TOIs)
- Search and Rescue (SAR) patterns
- Situation reports (SITREP)
- Static data

When a message is received a dialog is displayed onscreen.. The dialog will display the message and identify the sender and if applicable the link ID.

Example text message



The following options are available when a text message is received:

- *[Reply]*— Displays the onscreen keyboard so that a reply can be entered and sent.
- *[View inbox]*— Opens the messaging inbox so that you can view messages.
- *[Dismiss]*— Dismisses the dialog (the message will be saved in the messages inbox).

Sent and received messages are stored in the messages inbox.

The messages inbox can be accessed by creating a Messages app page on the Homescreen or from the *[My data]* menu: *[Homescreen > My data > Messages]*.

Transmission type

The messaging app uses various transmission types for different kinds of messages; these are: secure, non-secure, and safety related.

The available transmission types are dependent on AIS transceiver mode:

- *[Restricted]*— In restricted mode, only secure messages can be sent.
- *[Normal]*— In normal mode, the transmission type can be set to secure, non-secure or safety related.
- *[Receive only]*— In receive-only mode, messages cannot be sent but can still be received.

The transmission types are explained below:

- *[Secure]*— Secure messages can only be received by vessels that are using the same STEDs passphrase as the sender/broadcaster. Secure broadcast messages are limited to 79 characters in length. Secure direct messages are limited to 57 characters.
- *[Non-secure]*— Non-secure messages can be received by any vessel with a STEDs-compliant AIS transceiver, and does not require recipients to have the same STEDs passphrase as the sender/broadcaster. Non-secure broadcasts are limited to 86 characters in length. Non-secure direct messages are limited to 80 characters.
- *[Safety related]*— Safety-related messages can be received by any vessel with a STEDs-compliant AIS transceiver. This transmission type does not require recipients to have the same STEDs passphrase as the sender/broadcaster. Safety-related broadcasts are limited to 90 characters in length. Safety-related direct messages are limited to 85 characters.

Message inbox

The inbox stores all sent and received messages.

The transmission type is identified on the right side of the message. If a secure message has a Link ID then this will also appear on the right side of the message.

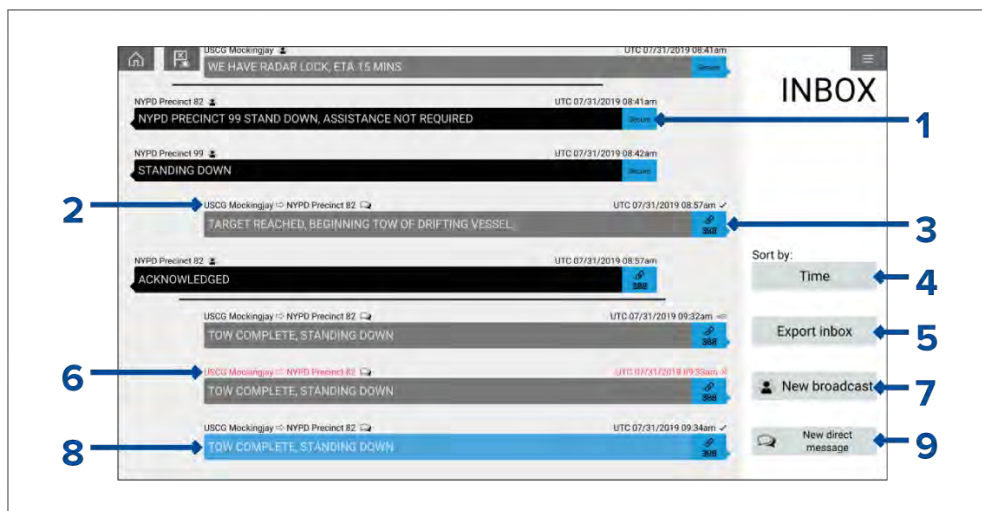

1. Received messages appear on the left side of the screen.
2. When a message is acknowledged, a tick is displayed after the date and time.
3. Sent messages appear on the right side of the screen.
4. *[Sort by]*— The inbox can be sorted by *time* or by *Link ID*. The sort by option is not available when the inbox is filtered.
5. *[Export inbox]*— Exports the current view / filter of messages to a .CSV (Comma Separated Values) spreadsheet file to a memory card inserted in the MFD's card reader. The Export inbox option is only available when a memory card is present in the MFD's card reader.
6. If a message has not been acknowledged, the text above the message will be displayed in red and an 'x' is displayed after the date and time.
7. *[New broadcast]*— Select to send a broadcast to all responder vessels.
8. Currently selected message is highlighted.
9. *[New direct message]*— Select to send a direct message to a specific responder vessel.

Note:

- The date and time provided for each inbox message is the last modified date, and may not be same as the date and time each message was originally created or received.
- Messages are removed from the inbox after a specified retention time.

Filtering

The inbox can be filtered to show only related messages or to show only messages from/to a specific sender. To filter the list of messages, select an inbox message and select either *[View messages from/to this sender]* or *[View related messages]*.

Inbox message retention

Inbox message retention can be set from 1 to 30 days. The inbox message retention can be set from the *[Responder][Advanced set-up]* menu: *[Homescreen > Settings > Responder > Advanced set-up > Configure > Message inbox > Retention days]*

Broadcasting a new message

Broadcast messages are sent over the AIS network and can be received by multiple vessels.

1. Select *[Broadcast message]* from the Chart app's *[New]* menu or select *[New broadcast]* from the Messages inbox.

The onscreen keyboard is displayed.

2. Enter your message.

Messages are subject to a character limit the amount of remaining character is shown on the onscreen keyboard. You can also select the speech bubble button to select a predefined message.

3. Select the TYPE button and select a transmission type.

If your AIS transceiver is in restricted mode only secure transmissions can be broadcast.

4. Select *[Send]*.
5. Select *[OK]*.

Sending a new direct message

A new direct message can be sent to specific vessel using its MMSI number or to an AIS vessel designated as a 'Buddy'.

1. Select *[Direct message]* from the chart app's *[New]* menu or select *[New direct message]* from the messages inbox.

The recent recipients list is displayed.

2. Select a recipient from either the recent list or from the Buddy list. Alternatively select *[Enter MMSI]* to enter a new recipient's MMSI number.
3. Select the transmission type for the message.

If your AIS transceiver is in restricted mode only secure transmissions can be broadcast.

4. Select *[Next]*.
5. Enter your message.

The onscreen keyboard is displayed. Messages are subject to a character limit the amount of remaining character is shown on the onscreen keyboard. You can also select the speech bubble button to select a predefined message.

6. Select *[Send]*.
7. If required, select the *[Request acknowledgement]* check box.
8. Select *[OK]*.

Direct message Blue Force targets

A direct message can be sent to Blue Force targets in the Chart app and Radar app.

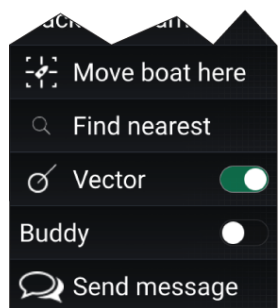

Open the Blue Force target's context menu and select *[Send message]* to display the onscreen keyboard, which can be used to enter your message. Once your message is complete, select *[Send]* to send it.

For more information on Blueforce AIS targets, refer to: [p.376 – Blue Force Tracking](#)

Replying to a message

You can reply to direct messages and broadcasts either from the message notification or from the inbox.

1. Select *[Reply]* from the message notification, or long hold on the inbox message and select either *[Reply]* or *[Broadcast reply]*.

The onscreen keyboard is displayed.

2. Enter your message.

Messages are subject to a character limit; the keyboard displays the number of remaining characters. You can also select the "speech bubble" icon to select a predefined message.

3. Select *[Send]*.
4. Select *[OK]*.

Onscreen keyboard

Use the messaging onscreen keyboard to type your messages.

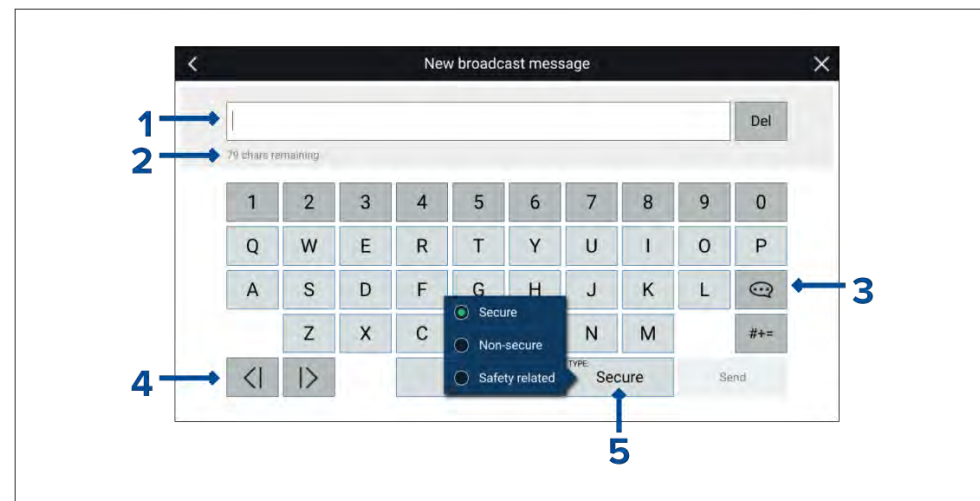







1. Text entry area.
2. Remaining characters.
3. Selecting the *[Template Text]* icon will change the onscreen keyboard to a list of template messages that can be used. Selecting *[My Position]* will enter your vessel's current coordinates into the message.

4. Move cursor.
5. Transmission type.

Message symbols

Symbols attached to messages in the *[Inbox]* indicate its type and status.

	<i>[Broadcast]</i> — A broadcast to all other responder vessels.
	<i>[Direct message]</i> — A direct message to a specific responder vessel.
	<i>[Sender]</i> — Indicates the sender (left of the arrow) and recipient (right of the arrow) of a direct message.
	<i>[Message sent]</i> — Direct message has been sent and acknowledged by the recipient's hardware.
	<p><i>[Message sending]</i>— Direct message is still waiting to be acknowledged as successfully received by the recipient's hardware.</p> <hr/> <p>Note:</p> <p>A maximum number of 4 attempts will be made to send the message by the sender's hardware, with 150 seconds of separation between each attempt.</p>

	<i>[Message failed to send]</i> — Direct message has failed to be acknowledged by the recipient's hardware.
	<hr/> <p>Note:</p> <p>The failed message will remain in the <i>[Inbox]</i>.</p>
	<i>[Link ID]</i> — A link ID generated and used by responder vessels.
	<hr/> <p>Note:</p> <p>Replying to a direct message or broadcast that has a link ID will send a reply that contains the same link ID.</p>

CHAPTER 25: DASHBOARD APP

CHAPTER CONTENTS

- 25.1 Dashboard app overview — page 390
- 25.2 Default data pages — page 391
- 25.3 Customizing a data item — page 391
- 25.4 Engine page — page 398
- 25.5 Sailing page — page 399
- 25.6 Race start page — page 400
- 25.7 Navigation page — page 401
- 25.8 Rolling road page — page 402
- 25.9 Fuel page — page 403
- 25.10 Tanks page — page 403
- 25.11 Bidata and single data pages — page 404
- 25.12 Generators page — page 404
- 25.13 CZone plug and play — page 406
- 25.14 App menu — page 407

25.1 Dashboard app overview

The Dashboard app enables you to view system data. System data may be generated by your MFD or by sensors and devices connected to your MFD via SeaTalk NG/NMEA 2000 and ethernet networks. The Dashboard app can also be configured to provide monitoring and control of compatible 3rd party digital control/switching systems.

Note:

For data to be available in the Dashboard app it must be transmitted to your MFD from compatible hardware using supported protocols and messages.

The Dashboard app can be displayed in Fullscreen and half screen portrait app pages.

For each instance of the Dashboard app you can select which pages you want to display, Page selection will persist over a power cycle.

Example Dashboard app pages

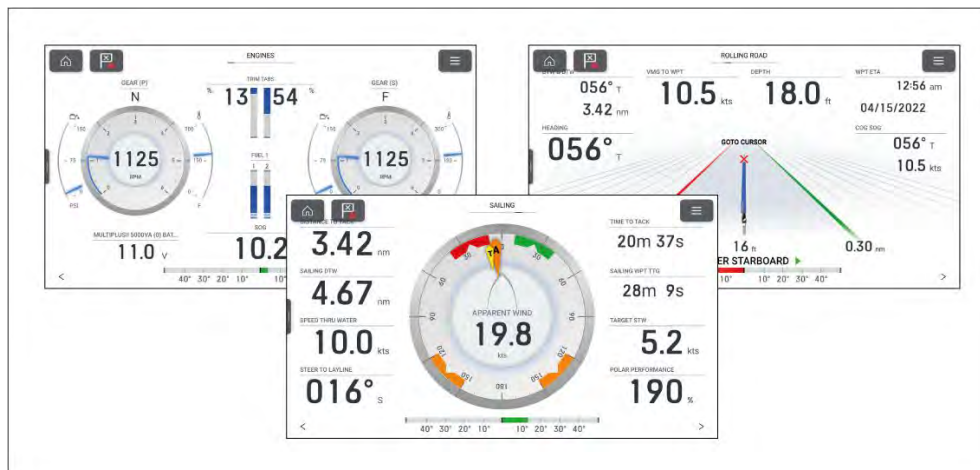

The Dashboard app is pre-configured with a number of customizable pages based on your chosen MFD profile and connected devices.

Dashboard app onscreen controls

MFD app use icons for controls which are permanently onscreen.

The following control icons are available in the Dashboard app:

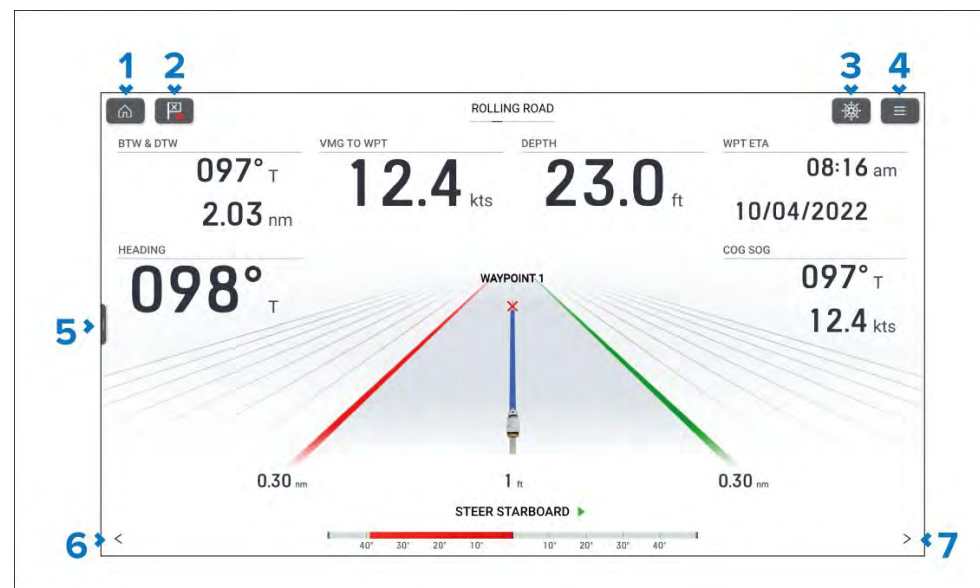

1. *[Home]*— Closes the app and displayed the homescreen.
2. *[Waypoint / MOB]*— Momentary press places a new waypoint at your vessel's current location. Long press activates the Man Over Board (MOB) alarm.
3. *[Pilot]*— Opens and closes the pilot sidebar.
4. *[Menu]*— Opens the app menu.
5. *[Sidebar]*— Press and slide right to open the sidebar.
6. *[<]*(Left arrow) — Displays the previous data page.
7. *[>]*(Right arrow) — Displays the next data page.

Switching data page

1. Use the *[<]*(Left arrow) and *[>]*(Right arrow) located at the bottom of the screen, to cycle through the available data pages.
2. Alternatively, you can select a specific data page from the app menu.

Selecting data pages to display

For each instance of the Dashboard app you can select which data pages you want to be available.

1. Select the *[Pages]* tab: *[Menu > Settings > Pages]*.

2. Select the relevant page from the list.
3. Select *[Hide page]* from the pop-over options to hide the page, or *[Show page]* so that the page will be available..

The selection will apply to the current instance of the Dashboard app.

25.2 Default data pages

The Dashboard app comes with a selection of default data pages. The defaults pages can be customized and hidden from view. New data pages can also be created, customized and deleted.

The following pages are available by default:

- Engines. For details refer to: [p.398 — Engines page](#)
- Sailing (only shown if boating activity is set to Sailing in startup wizard). For details refer to: [p.399 — Sailing page](#)
- Race start (only shown if boating activity is set to Sailing in startup wizard). For details refer to: [p.400 — Race start page](#)
- Navigation. For details refer to: [p.401 — Navigation page](#)
- Rolling road. For details refer to: [p.402 — Rolling road page](#)
- Fuel. For details refer to: [p.403 — Fuel page](#)
- Tanks. For details refer to: [p.403 — Tanks page](#)
- Bidata. For details refer to: [p.404 — Bidata and single data pages](#)
- Single data. For details refer to: [p.404 — Bidata and single data pages](#)

A list of all data pages is available on the *[Pages]* settings menu: *[Menu > Settings > Pages.]*

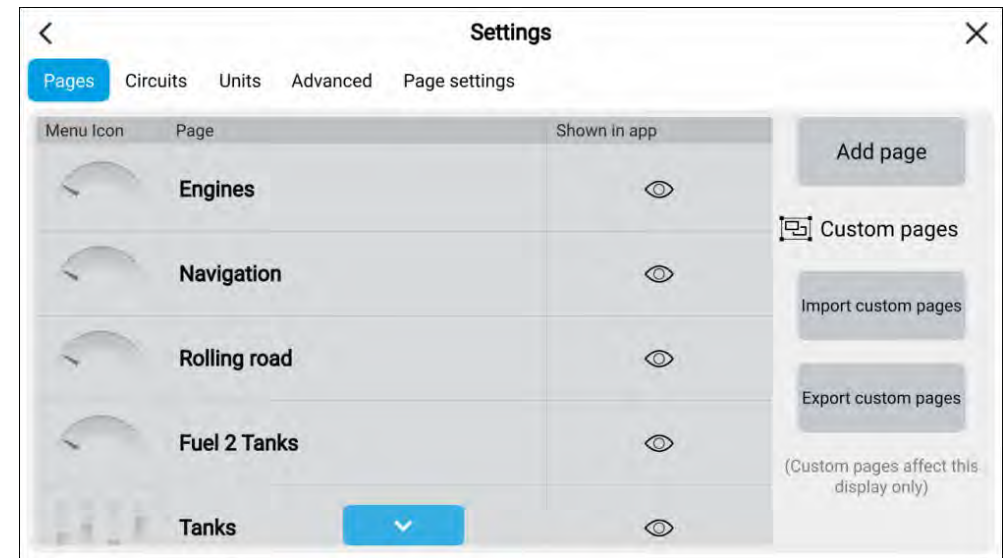

25.3 Customizing a data item

The data items displayed on each page can be changed.

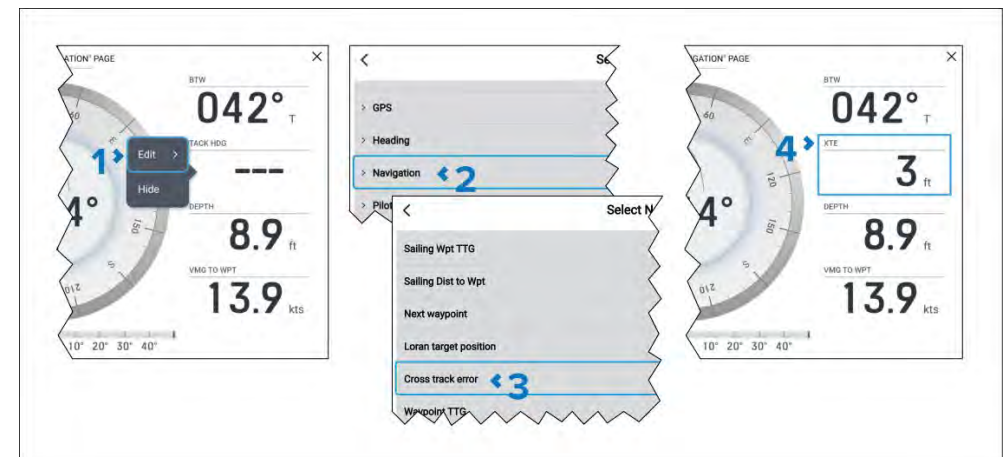

1. Select and hold on the data item you want to change and then Select *[Edit]* from the pop-over menu.
2. Select a data category from the list.
3. Select the new data item from the chosen category.

4. The new data item is displayed.

Alternatively, to use physical buttons instead of the touchscreen you can select *[Customize page]* from the app menu: *[Menu > Customize page]* and then follow the steps above.

Display data

Data transmitted by compatible devices connected to the same network as the display, as well as data generated by the display, can be shown as data items in the Dashboard app, the sidebar and as a data overlay.

Data items are organized into categories.

Note:

- Standard NMEA 2000 PGNs are listed next to the relevant data items.
- Supported Raymarine and third-party proprietary messages are not listed.
- NMEA 0183 sentences are not shown.

To view a list of all supported NMEA 2000 PGNs, refer to:

[p.540 — NMEA 2000 PGN support](#)

To view a list of all supported NMEA 0183 sentences, refer to:

[p.539 — NMEA 0183 sentence support](#)

To change or add a data item in the Dashboard app or sidebar, select and hold on the data cell and select *[Edit]* from the pop-over options to display the list of data categories.

To change or add a data item to a data overlay, use the *[Page settings]* menu from the relevant MFD app. For details, refer to: [p.49 — Data overlays](#)

Battery data

Batteries are detected automatically by the display.

If no compatible batteries are detected the *[Battery]* category will be hidden.

The following data items are available in the *[Battery]* category:

- *Battery voltage* (PGN 127508)
- *Battery current* (PGN 127508)
- *Time till zero charge* (PGN 127506)
- *Battery temperature* (PGN 127508)
- *State of charge* (PGN 127506)

The data items will be available for each detected battery.

Detected batteries are shown in the battery configuration page: *[Homescreen > Settings > Boat details > Num of batteries > Configure batteries]*.

Boat data

Boat data requires supported sensors to be connected.

The following data items are available in the *[Boat]* category:

- ⁽¹⁾ *Sail recommendation (Main)*
- ⁽¹⁾ *Sail recommendation (Headsail)*
- *Rudder angle* (PGN 127245)
- *Rate of turn* (PGN 127251)
- ⁽²⁾ *Roll* (PGN 127257)
- ⁽³⁾ *Steering angle*
- *Mast rotation*
- *Pitch* (PGN 127257)
- ⁽¹⁾⁽²⁾ *Sail recommendation*
- *Trim tabs*⁽¹⁾ (PGN 130576)

Note:

- (1) Requires Sailing activity and imported Sail plan.
- (2) Data item can only be displayed in the Dashboard app.
- (3) Requires Mercury engine integration.

Depth data

Depth data requires a compatible instruments or sonar transducer connected to the display.

The following data items are available in the *[Depth]* category:

- *Maximum depth*
- *Minimum depth*
- *Depth* (PGN 128267)

Display data

The display data category is used for voltage detected by the display.

The following data items are available in the *[Display]* category:

- *Supply voltage*
- *Supply voltage level*⁽¹⁾

Note:

- The display category and data items are not available in the Dashboard app.
- (1) Data item is only available in the sidebar.

Distance data

Distance data requires a compatible speed transducer and or GNSS receiver.

The following data items are available in the *[Distance]* category:

- *Distance to line*
- *Distance to tack*
- *Trip (manual)*
- *Trip (month)*
- *Trip (day)*
- *Trip (season)*
- *Ground log* (PGN 128275)
- *Trip* (PGN 128275)
- *Log* (PGN 128275)
- *Log Trip*⁽¹⁾ (PGN 128275)
- *Line bias*

Note:

- (1) Data item is only available in the Dashboard app

Engine data

Engine data requires the display to be connected to a supported engine management system. Depending on manufacturer a compatible engine interface or gateway may be required.

The following data items are available in the *[Engine]* category:

- *Exhaust Gas Temperature* (PGN 130316)
- *Engine*

[Dashboard app](#)

The following items will be available for each engine.

- *Jack plate position* (PGN 128780)
- *RPM* (PGN 127488)
- *Engine trip* (PGN 127497)
- *Trans oil temp* (PGN 127493)
- *Fuel flow (avg)* (PGN 127497)
- *Trans oil pressure* (PGN 127493)
- *Gear* (PGN 127493)
- *Oil temperature* (PGN 127489)
- *Alternator* (PGN 127489)
- *Boost pressure* (PGN 127488)
- *Oil pressure status* (PGN 127489)
- *Oil pressure* (PGN 127489)
- *Engine hours* (PGN 127489)
- *Coolant temperature* (PGN 127489)
- *Coolant pressure* (PGN 127489)
- *Fuel pressure* (PGN 127489)
- *Fuel flow (inst)* (PGN 127489)
- *Tilt position* (PGN 127488)
- *Engine load* (PGN 127489)
- *Fuel flow* (PGN 127489)

Engine configuration settings are available in the *[Boat details]* settings menu: *[Homescreen > Settings > Boat details > Num of engines]*.

Fuel data

The fuel data category include items related to fuel management. Fuel management is dependent on engine data being available on the SeaTalk NG[®] backbone.

The following data items are available in the *[Fuel]* category:

- *Total propulsive fuel (vol)*
- *Total fuel (vol)* (PGN 127505)
- *Total fuel (%)*
- *Fuel (vol)*⁽¹⁾

- *Fuel (%)*⁽¹⁾
- *Fuel used (trip)* (PGN 127497)
- *Est. fuel remaining* (PGN 127496)
- *Engine economy total* (PGN 127497)
- *Time to empty* (PGN 127496)
- *Distance to empty* (PGN 127496)
- *Fuel flow total* (PGN 127497 / PGN 127489)
- *Fuel used (season)* (PGN 127497)

The data items above will be available for each configured fuel tank. When more than 1 fuel tank is configured then the data items will be provided in the *[All Tanks]* category and will combine the fuel data items for all tanks.

Note:

(1) For systems with multiple fuel tanks these data items will remain available for each individual tank.

Environment data

Environmental data items require connection of compatible sensors and transducers.

The following data items are available in the *[Environment]* category:

- *True wind chill*
- *App wind chill* (PGN 130312 / 130316)
- *Max water temp*
- *Min water temp*
- *Water temp* (PGN 130310 / 130311 / 130312 / 130316)
- *Max air temp*
- *Min air temp*
- *Drift* (PGN 129291)
- *Dew point* (PGN 130312 / 130316)
- *Barometric pressure* (PGN 130310)
- *Air temp* (PGN 130310)
- *Set* (PGN 129291)
- *Humidity* (PGN 130310 / 130311 / 130313)

- *Sunset Sunrise*⁽¹⁾
- *Set Drift*⁽¹⁾ (PGN 129291)
- *Water & Supply*⁽¹⁾

Note:

- (1) Data items are only available in the Dashboard app

Inside environment data

Inside environmental data items require connection of compatible sensors. The following data items are available in the *[Inside environment]* category:

- *Inside humidity* (PGN 130313)
- *Inside temperature* (PGN 130316)

The data items above will be available for the number of interior environmental sensors specified in the *[Boat details]* settings menu: *[Homescreen > Settings > Boat details > Num of interior environment sensors]*.

GPS data

The GPS data category contains data items related to the GNSS receiver in use by your display.

The following data items are available in the *[GPS]* category:

- *Cursor position*
- *Loran cursor position*
- *Loran position*
- *Course over ground* (PGN 129026)
- *Average SOG*
- *Maximum SOG*
- *Speed over ground SOG* (PGN 129026)
- *Vessel position* (PGN 129025 / PGN 129029)
- *COG SOG* (Course Over Ground) (Speed Over ground)⁽¹⁾ (PGN 129026)
- *Opp. tack COG* (PGN 129026)
- *Maximum SOG (all time)* (PGN 129026)

Note:

- (1) Data item is only available in the Dashboard app

Heading data

Heading data requires a connected sensor providing vessel heading. The following data items are available in the *[Heading]* category:

- *Steer to layline*⁽¹⁾
- *Heading error*
- *Locked heading*
- *Heading* (PGN 127250)
- *Opp. tack COG*
- *Course over ground*
- *Opp. tack heading*
- *Locked heading & Error*⁽²⁾
- *Heading & Speed*⁽²⁾

Note:

- (1) *[Steer to layline]* data will only be populated when the boating activity has been set to sailing in the initial MFD start up wizard.
- (2) Data item is only available in the Dashboard app.

Navigation data

Navigation data requires a compatible sensor providing position related data. Active navigation is required for waypoint and route related data items.

The following data items are available in the *[Navigation]* category:

- *Sailing time to waypoint*
- *Sailing distance to waypoint*
- *Next waypoint*
- *Loran target position*
- *Cross tack error* (PGN 129283)
- *Time to waypoint*
- *Time to destination*
- *Target position*
- *ETA at waypoint (time & date)* (Estimated Time of Arrival) (PGN 129284)
- *ETA at destination (time & date)* (Estimated Time of Arrival) (PGN 129284)

[Dashboard app](#)

- *Course to steer*
- *Next track leg bearing*
- *Distance to waypoint*
- *Distance made good*
- *Course made good*
- *Bearing origin to waypoint*
- *Bearing to waypoint*
- *Active waypoint*
- *ETA at destination* (Estimated Time of Arrival)
- *ETA at waypoint* (Estimated Time of Arrival) (PGN 129284)
- *Distance to go*
- *CTS & DTW*⁽¹⁾ (Course To Steer & Distance To Waypoint)
- *CMG & VMG*⁽¹⁾ (Course Made Good & Velocity Made Good)
- *BTW & DTW*⁽¹⁾ (Bearing To Waypoint & Distance To Waypoint)
- *Waypoint info*⁽¹⁾
- *CMG & DMG*⁽¹⁾ (Course Made Good & Distance Made Good)

Note:

- (1) Data item is only available in the Dashboard app

Pilot data

A rudder reference transducer is required for pilot data items.

The following data items are available in the *[Pilot]* category:

- *Rudder angle* (PGN 127245)
- *Steering angle* (Requires Mercury engine integration.)

Speed data

Speed data includes data items related to vessel speed.

The following data items are available in the *[Speed]* category:

- *VMG to waypoint* (Velocity Made Good)
- *Speed thru water* (PGN 128259)
- *VMG to windward* (Velocity Made Good)

- *Avg speed*
- *Max speed*
- *Maximum SOG (all time)*
- *Target speed*
- *Polar performance*⁽¹⁾

Note:

(1) [*Polar performance*] data will only be populated when the boating activity is set to **Sailing** in the initial MFD start up wizard.

Time data

Time data requires a compatible device to be connected providing time data.

The display the following data items are available in the [*Time*] category:

- *Sunset time*
- *Sunrise time*
- *UTC date* (Universal Time Coordinated) (PGN 129033)
- *UTC time* (Universal Time Coordinated) (PGN 129033)
- *Race timer*
- *Date* (PGN 126992)
- *Time* (PGN 126992)
- *Time to tack*
- *Time to burn*

Wind data

Wind data requires a compatible wind transducer to be connected.

The following data items are available in the [*Wind*] category:

- *Next leg TWA* (PGN 128259 & 130306)
- *Target Apparent Wind Angle* (PGN 128259 & 130306)
- *Target True Wind Angle* (PGN 128259 & 130306)
- *Wind shift*
- *True wind angle* (PGN 128259 & 130306)
- *Cardinal*
- *Beaufort*

- *Ground wind direction* (Ground Wind Direction) (PGN 130306 / 129026)
- *Ground wind speed* (Ground Wind Direction) (PGN 130306 / 129026)
- *True wind direction* (PGN 128259 & 130306 & 127250)
- *Minimum true wind angle*
- *Maximum true wind angle*
- *Minimum true wind speed*
- *True wind speed* (PGN 128259 & 130306)
- *Maximum app wind speed*
- *App wind speed* (PGN 130306)
- *Minimum app wind angle*
- *App wind angle* (PGN 130306)
- *Maximum app wind angle*
- *Minimum app wind speed*
- *Minimum true wind speed*
- *GWD & Beaufort*⁽¹⁾ (Ground Wind Direction) (PGN 130306 / 129026)
- *GWS & GWD*⁽¹⁾ (Ground Wind Speed & Ground Wind Direction)
- *AWA & VMG*⁽¹⁾ (Apparent Wind Angle & Velocity Made Good)
- *AWA & AWS*⁽¹⁾ (Apparent Wind Angle & Apparent Wind Speed)
- *TWA & VMG wind*⁽¹⁾ (True Wind Angle & Velocity Made Good)
- *TWA & TWS*⁽¹⁾ (True Wind Angle & True Wind Speed)

Note:

(1) Data item is only available in the Dashboard app

Tank level data

Tank level data shows the percentage fill for each detected tank.

The following data categories are available for tanks:

- *Fuel (Gasoline)*
- *Fresh water* (PGN 127505)
- *Live well* (PGN 127505)
- *Grey water* (PGN 127505)
- *Black water* (PGN 127505)

Each tank type has its own data category and if more than 1 tank of each type is detected there will be subcategory for each tank.

Generator data

The generator data category is only available when a generator transmitting supported NMEA 2000 PGNs is detected by the display.

The following data items are available in the *[Generator]* category:

- *Engine load* (PGN 127489)
- *Engine RPM* (PGN 127488)
- *Fuel flow* (PGN 127489)
- *Coolant temperature* (PGN 127489)
- *Oil temperature* (PGN 127489)
- *Oil pressure* (PGN 127489)
- *Oil pressure (status)* (PGN 127489)
- *Generator battery voltage* (PGN 127508)
- *Engine hours* (PGN 127489)
- *Exhaust gas temperature* (PGN 130316)
- *Generator state* (PGN 127514)
- *Generator voltage* (PGN 127751)
- *Generator current* (PGN 127751)

The data items above will be available for each detected generator.

- *Generator line 1 power* (PGN 127744)
- *Generator line 1 current* (PGN 127744)
- *Generator line 1 to neutral voltage* (PGN 127747)
- *Generator line 1 to line 2 voltage* (PGN 127747)
- *Generator line 1 frequency* (PGN 127747)
- *Generator line 2 power* (PGN 127745)
- *Generator line 2 current* (PGN 127745)
- *Generator line 2 to neutral voltage* (PGN 127748)
- *Generator line 2 to line 3 voltage* (PGN 127748)

- *Generator line 2 frequency* (PGN 127748)
- *Generator line 3 power* (PGN 127746)
- *Generator line 3 current* (PGN 127746)
- *Generator line 3 to neutral voltage* (PGN 127749)
- *Generator line 3 to line 1 voltage* (PGN 127749)
- *Generator line 3 frequency* (PGN 127749)

The additional data items above will be available for each detected 3 phase generator.

Load cell data

Load cells are sensors used to measure the load bearings on key rigging components, such as forestay, sidestay, backstay, or any sheet, halyard, control line, vang, tack line, or runner.

A predefined list of *[Load cells]* is available.

For load cell data to be populated a supported load cell gateway is required.

Cyclops Marine load cells

Cyclops Marine is a third party company providing wireless load-sensing devices for use in sailing, and especially race sailing.

The Cyclops Marine sensors connect wirelessly to the below-deck Cyclops Marine Gateway, which interfaces with compatible Raymarine MFDs and displays key load bearings at identified stress points on a yacht's rigging.

In the MFD's Dashboard app, you can see at a glance the live, static and dynamic load data transmitted by the Cyclops Marine sensors, at up to 50 sensor placements.

25.4 Engine page

The engine page is always available. The number of engines displayed on the engine page is based on the number of engines selected during the initial MFD start up wizard. The engine page includes data relevant to engines and includes the graphical engine dial.

Example single engine data page

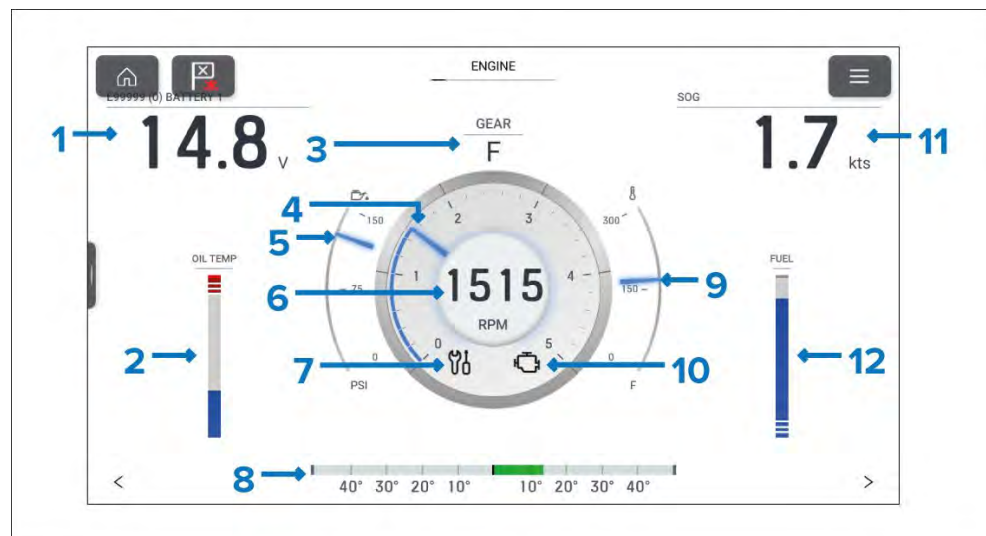

1. **BATTERY 1** — Engine battery voltage.
2. **OIL TEMP** — Engine oil temperature.
3. **GEAR** — Transmission gear.
4. **RPM indicator** — Graphical representation of engine RPM.
5. **Oil pressure indicator** — Current engine oil pressure indication.
6. **RPM** — Digital RPM value.
7. **Maintenance indicator** — Illuminates when engine maintenance is required.
8. **Rudder bar** — Provides an indication of rudder position.
9. **Coolant temperature** — Current engine coolant temperature indication.
10. **Check engine** — Illuminates when an engine fault is detected.
11. **SOG** — Speed Over Ground.

12. **FUEL** — Graphical representation of the percentage of fuel remaining.

The engine dial and its contents are unique to the engine page and cannot be reproduced on other data pages. The engine dial cannot be removed or hidden.

Data items 1,2, 9 and 10 can be customized. Data items 3 and 7 can be hidden if desired.

Multi engine page examples

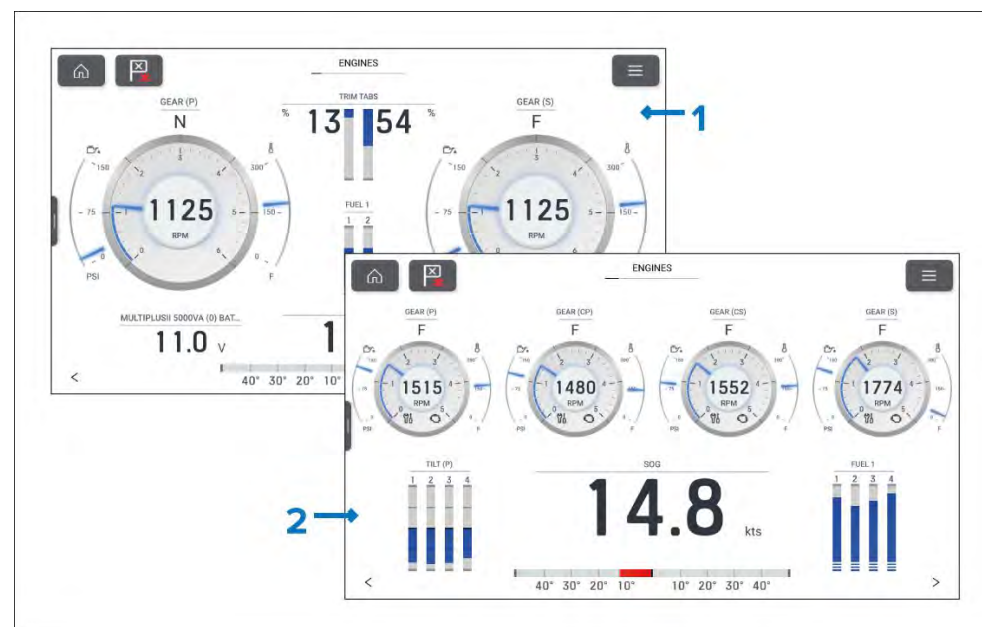

1. 2 engine page example.
2. 4 engine page example

When the MFD has been configured with more than 1 engine the page layout and data is changed appropriately for the number of engines up to 5.

Note:

The number of engines displayed on the engine page can only be changed by performing a factory reset and choosing a different number of engines at the start up wizard.

25.5 Sailing page

The sailing data page is available when the MFD has been configured to use the Sailing boating activity during the initial MFD start up wizard. The sailing page includes data relevant to sailing and includes a graphical sailing dial.

The apparent wind dial is the default dial displayed on the sailing page.

When the *[Sail performance]* setting has been configured dynamic wind angle targets will be displayed. The sail performance setting can be configured from the *[Boat details]* menu: *[Homescreen > Boat details > Sail performance]*.

If the *[Sail performance]* setting has not been configured then close hauled angle indicators are displayed instead of wind angle targets.

The sailing page can be used in combination with the Laylines feature available in the chart app to optimize your sailing performance. For details about the layline features refer to: [p.286 — Laylines](#)

Example — Sailing page with apparent wind sailing dial

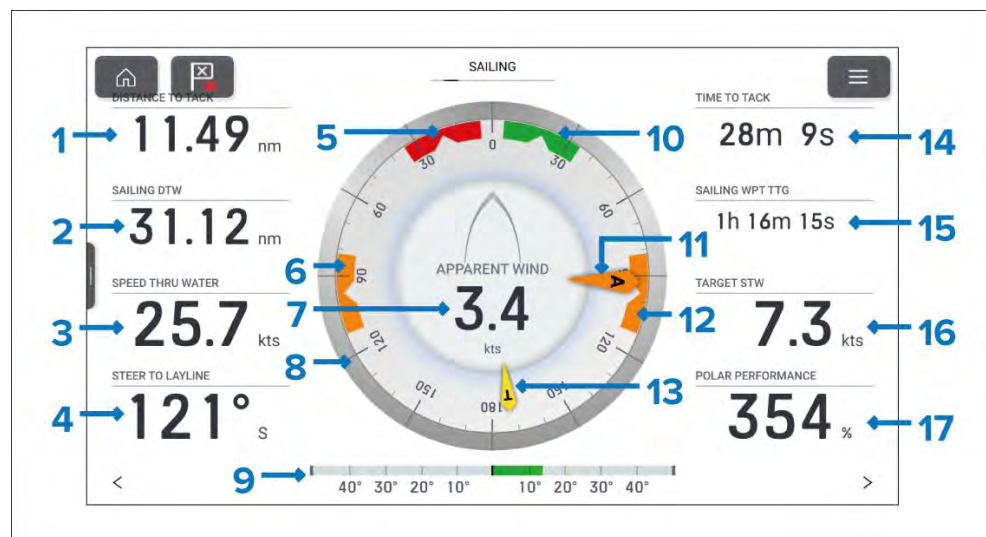

1. **DISTANCE TO TACK** — Distance to go before performing a tack.
2. **SAILING DTW** — Distance To Waypoint (current destination waypoint or goto location).
3. **SPEED THRU WATER** — Current vessel speed received from speed transducer.
4. **STEER TO LAYLINE** — Heading to steer to layline.

Dashboard app

5. **Port wind angle target** — Align the larger wind indicator (AWA or TWA) with the notch to optimize Velocity Made Good (VMG) when tacking to port upwind.
6. **Downwind angle target** — Align the larger wind indicator (AWA or TWA) with the notch to optimize Velocity Made Good (VMG) when gybing downwind
7. **Apparent wind speed**
8. **Compass dial** — The compass dial remains fixed and the indicators move around the dial to indicator direction/angle.
9. **Rudder bar** — Provides an indication of rudder position.
10. **Starboard wind angle target** — Align the larger wind indicator (AWA or TWA) with the notch to optimize Velocity Made Good (VMG) when tacking to starboard upwind.
11. **AWA indicator** — Apparent Wind Angle.
12. **Downwind angle target** — Align the larger wind indicator (AWA or TWA) with the notch to optimize Velocity Made Good (VMG) when gybing downwind
13. **TWA indicator** — True Wind Angle.
14. **TIME TO TACK** — Time left to tack.
15. **SAILING WPT TTG** — Waypoint Time To Go (current destination waypoint or goto location).
16. **TARGET STW** — Speed Through Water target.
17. **POLAR PERFORMANCE**

The apparent wind dial can be changed to one of the alternative sailing dials. For details refer to: [p.400 — Sailing dials](#)

The sailing dials are unique to default pages and cannot be reproduced on custom data pages.

Data items 1 to 4 and 14 to 17 can be customized. Data item 9 can be hidden if desired.

Sailing dials

There are several variations of the sailing dial that can be displayed in the Navigation, page, sailing page and race start page.

Examples — Dashboard app sailing dials

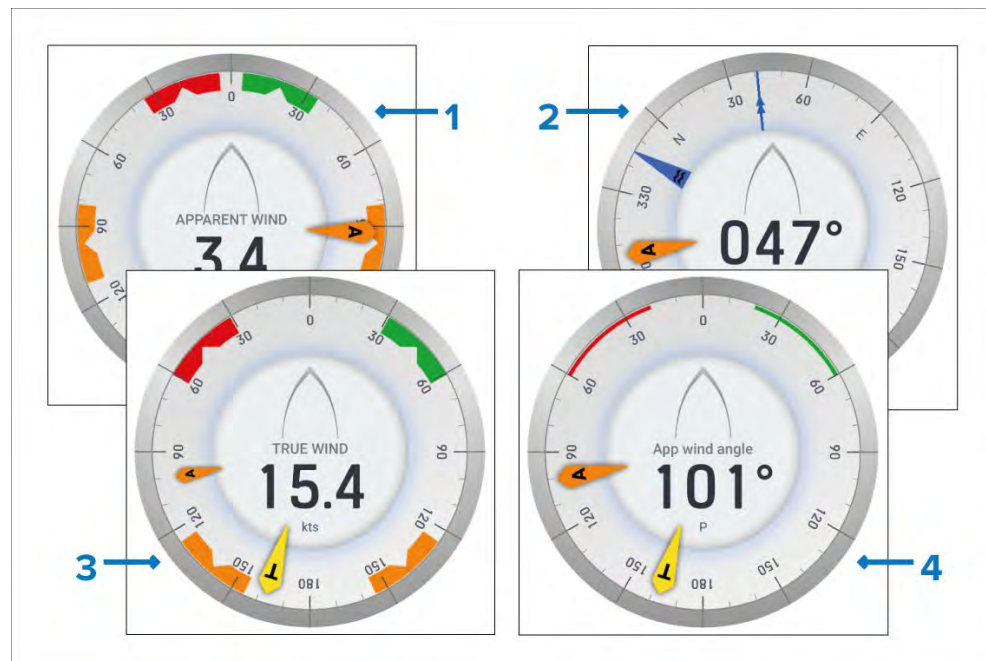

1. **Apparent wind dial** — For details refer to: [p.399 — Sailing page](#)
2. **Navigation dial** — For details refer to: [p.401 — Navigation page](#)
3. **True wind dial** — The true wind dial uses true wind values instead of apparent wind values.
4. **Sailing wind angle dial** — The sailing wind angle dial displays digital wind angle instead of apparent wind speed of true wind speed.

25.6 Race start page

The race start data page is available in the Dashboard app, when the MFD has been configured to use the Sailing boating activity during the initial MFD start up wizard. The race start page includes data relevant to race sailing and includes a graphical sailing dial.

The apparent wind dial is the default dial displayed on the race start page.

When the *[Sail performance]* setting has been configured dynamic wind angle targets will be displayed. The sail performance setting can be configured from the *[Boat details]* menu: *[Homescreen > Boat details > Sail performance]*.

If the *[Sail performance]* setting has not been configured then close hauled angle indicators are displayed instead of wind angle targets.

The race start page can be used in combination with the Laylines feature and race start line feature available in the chart app to optimize your sailing performance. For details about the layline features refer to:

- [p.286 — Laylines](#)
- [20.7 Race Start Line \(SmartStart\) and Race Timer](#)

Example — Race start page with apparent wind sailing dial

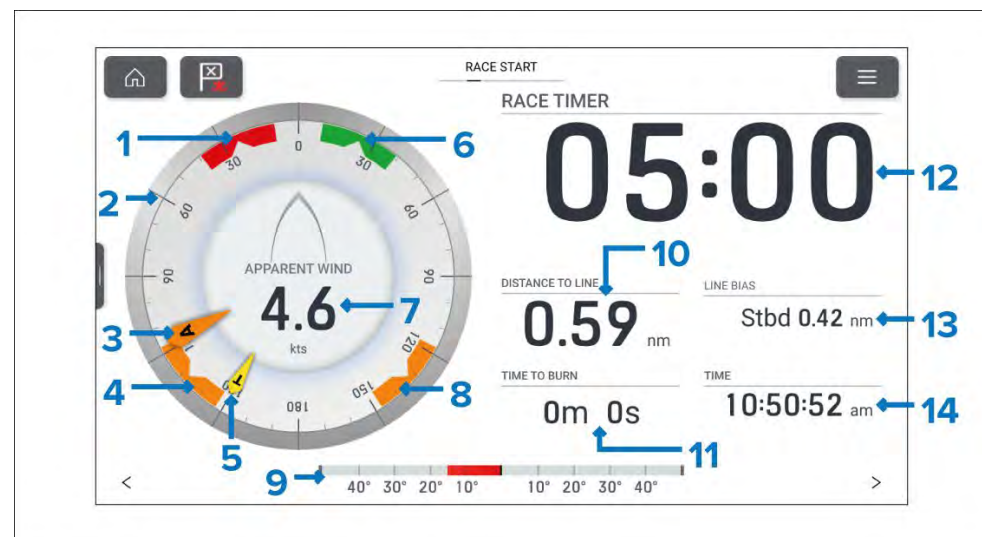

1. **Port wind angle target** — Align the larger wind indicator (AWA or TWA) with the notch to optimize Velocity Made Good (VMG) when tacking to port upwind.

2. **Compass dial** — The compass dial remains fixed and the indicators move around the dial to indicator direction/angle.
3. **AWA indicator** — Apparent Wind Angle.
4. **Downwind angle target** — Align the larger wind indicator (AWA or TWA) with the notch to optimize Velocity Made Good (VMG) when gybing downwind
5. **TWA indicator** — True Wind Angle.
6. **Starboard wind angle target** — Align the larger wind indicator (AWA or TWA) with the notch to optimize Velocity Made Good (VMG) when tacking to starboard upwind.
7. **Apparent wind speed**
8. **Downwind angle target** — Align the larger wind indicator (AWA or TWA) with the notch to optimize Velocity Made Good (VMG) when gybing downwind
9. **Rudder bar** — Provides an indication of rudder position.
10. **DISTANCE TO LINE** — Distance to your race start line.
11. **TIME TO BURN** — The time to wait to cross the start line at maximum speed.
12. **RACE TIMER** — Select the race timer to configure and start/stop the race timer.
13. **LINE BIAS** — Helps to determine the optimum point to cross the start line.
14. **TIME** — Current time.

The apparent wind dial can be changed to one of the alternative sailing dials. For details refer to:

The sailing dials are unique to default pages and cannot be reproduced on custom data pages.

Data items 10, 11, 13 and 14 can be customized. Data item 9 can be hidden if desired.

25.7 Navigation page

The navigation data page is always available. The navigation page includes data relevant to navigation and includes a graphical navigation compass dial.

Default Navigation page

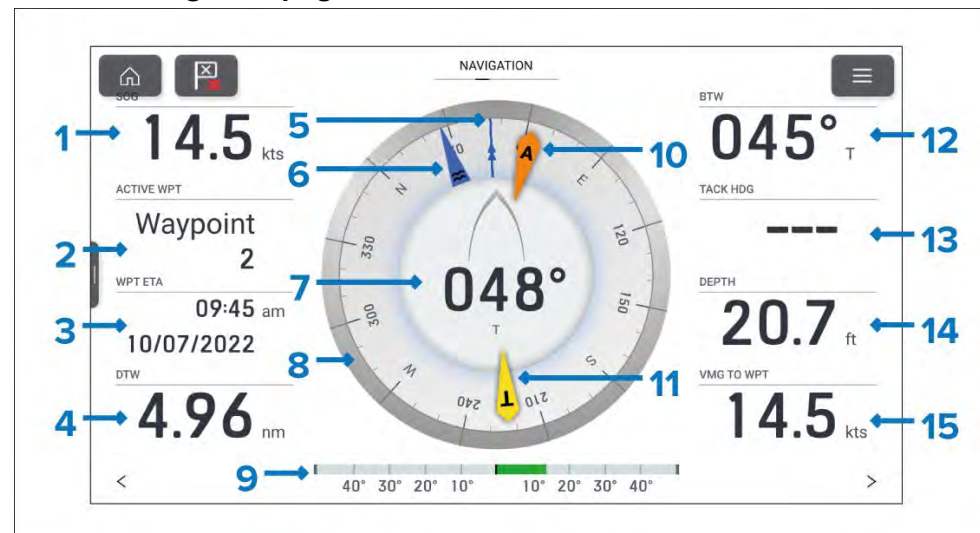

1. **SOG** — Speed Over Ground.
2. **ACTIVE WPT** — Active waypoint is the current destination (waypoint or goto location).
3. **WPT ETA** — Estimated time of arrival for the active waypoint location.
4. **DTW** — Distance to the active waypoint.
5. **COG indicator** — Course Over Ground.
6. **Tide indicator** — Tide direction.
7. **Heading** — Vessel heading.
8. **Compass dial** — The compass dial will rotate to provide indication of heading.
9. **Rudder bar** — Provides an indication of rudder position.
10. **AWA indicator** — Apparent Wind Angle.
11. **TWA indicator** — True Wind Angle.
12. **BTW** — Bearing to the active waypoint.
13. **Tack hdg** — Tack heading.

14. **Depth** — Water depth.

15. **VMG to WPT** — Velocity Made Good to Waypoint.

The navigation dial and its contents are unique to the navigation page and cannot be reproduced on other data pages. The navigation dial cannot be removed or hidden.

Data items 1 to 4 and 12 to 15 can be customized. Data item 9 can be hidden if desired.

Close hauled angle indicators

If the *[Sail performance]* setting has not been configured then sailing dials will display fixed port and starboard close hauled angle indicators instead of the dynamic port, starboard and downwind angle targets.

Example — Sailing dial with close hauled angle indicators

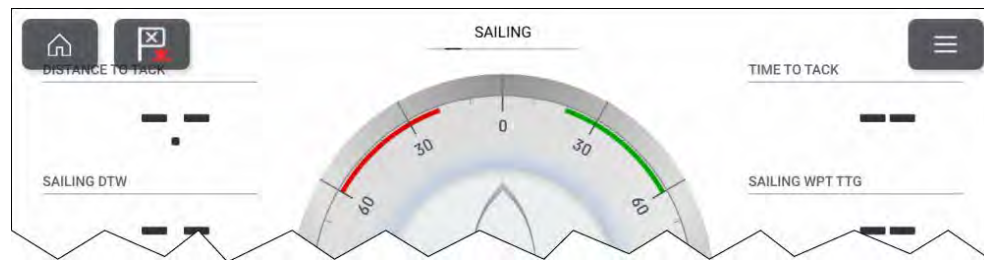

25.8 Rolling road page

The rolling road data page is always available. The rolling road page includes data relevant to navigation and includes a graphical rolling road.

Default Navigation page

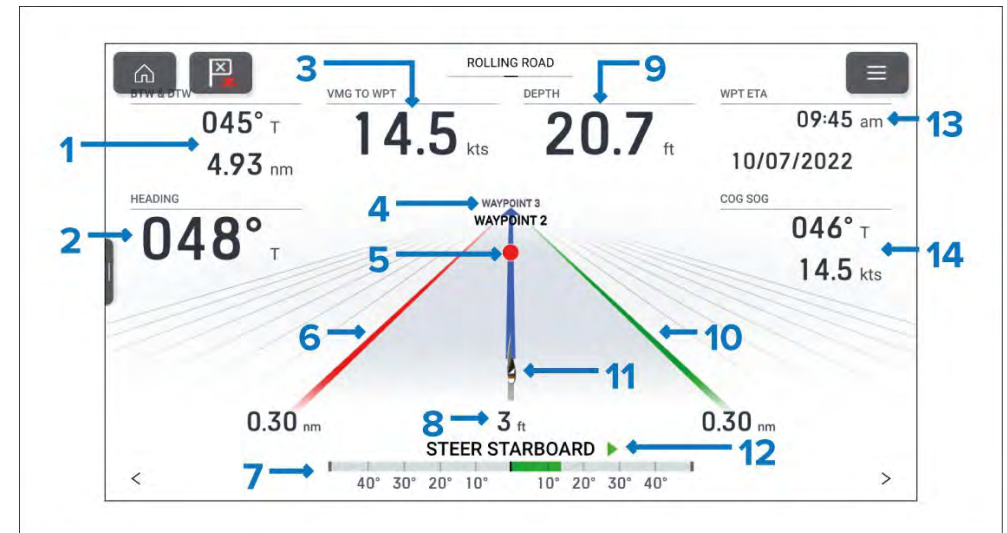

1. **BTW & DTW** — Bearing and distance to active waypoint or goto location.
2. **HEADING** — Current vessel heading.
3. **VMG TO WPT** — Velocity Made Good to the active waypoint or goto location.
4. **Next waypoint** — When following a route the next waypoint is displayed.
5. **Active waypoint symbol** — Active waypoint is the current destination (waypoint or goto location).
6. **Port boundary line**
7. **Rudder bar** — Provides an indication of rudder position.
8. **Cross Track Error (XTE)** — Distance from track line.
9. **Depth** — Current water depth.
10. **Starboard boundary line**
11. **Vessel icon** — Current vessel position.
12. **Steering indicator** — Provides steering instruction.
13. **WPT ETA** — Estimated time of arrival for the active waypoint location.

14. **COG SOG** — Course Over Ground & Speed Over Ground.

The rolling road graphic can be reproduced on custom pages using the *[Navigation > Rolling road data item]*. The rolling road graphic can be changed or hidden.

Data items 1 to 3, 9, 13 and 14 can be customized. Data item 7 and 12 can be hidden if desired.

25.9 Fuel page

The fuel data page is always available. The number of fuel tanks displayed on the fuel page is based on the number of fuel tanks selected during the initial MFD start up wizard. If more than 1 fuel tank is selected then the first 2 tanks will be displayed. The fuel page includes data relevant to fuel usage and includes a graphical fuel dial.

Example fuel page

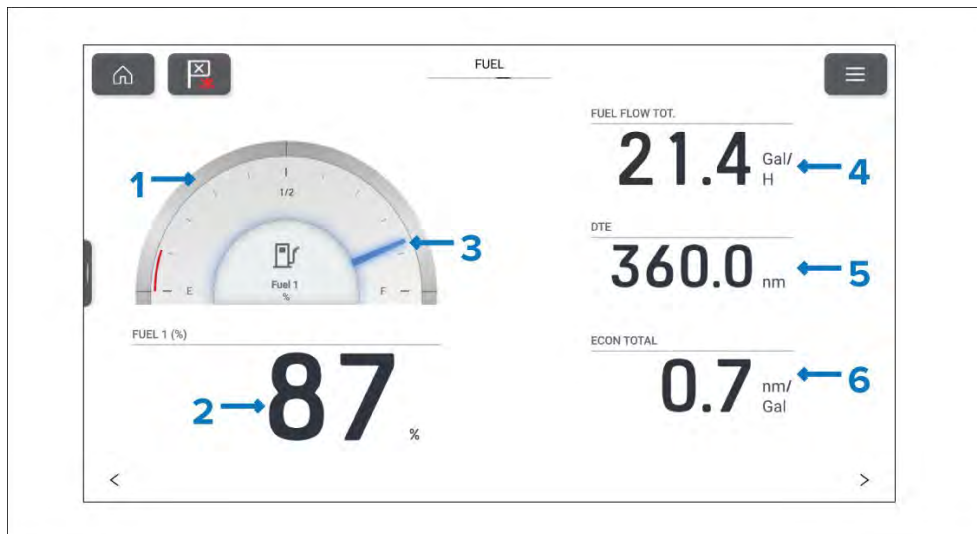

1. **Fuel graphic**
2. **Fuel (%)** — Indication of percentage fuel remaining.
3. **Fuel indicator** — Indication of percentage fuel remaining.
4. **FUEL FLOW TOT.** — Total fuel flow.
5. **DTE** — Distance To Empty.

Dashboard app

6. **ECON TOTAL** — Total fuel economy.

The fuel dial is unique to the fuel page and cannot be reproduced on other data pages. The fuel dial can be changed or hidden. All other data items on the fuel page can also be customized or hidden if desired.

Note:

The number of fuel tanks displayed on the fuel page can only be changed by performing a factory reset and choosing a different number of fuel tanks at the start up wizard.

25.10 Tanks page

The tanks data page is always available. The number of tanks displayed is based on the number of each type of tank selected during the initial MFD start up wizard. The tanks page shows the capacity remaining for each tank.

Example tanks page

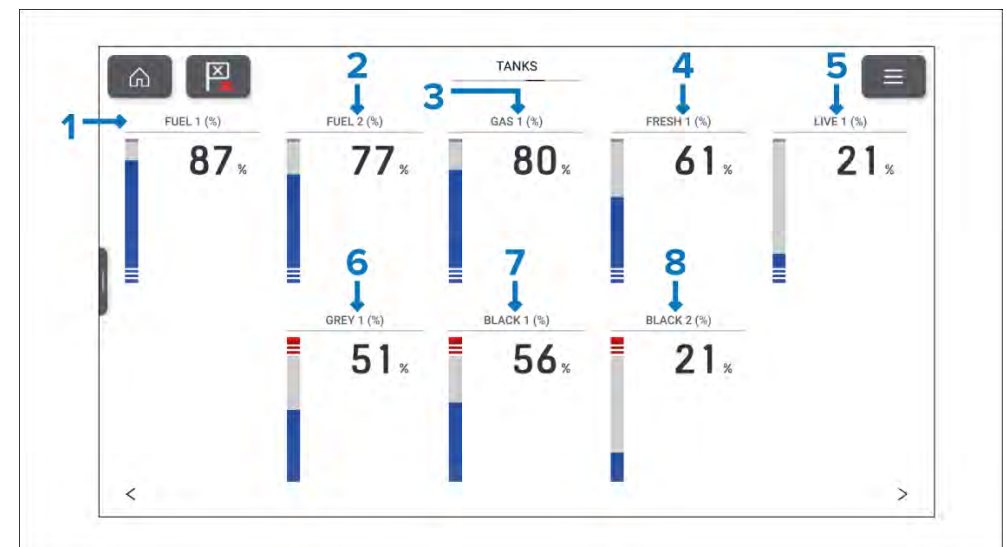

1. **FUEL 1 (%)** — Percentage of fuel remaining in Fuel tank 1.
2. **FUEL 2 (%)** — Percentage of fuel remaining in Fuel tank 2.
3. **GAS 1 (%)** — Percentage of fuel remaining in Gasoline tank 1.

4. **FRESH 1 (%)** — Percentage of fresh water remaining in fresh water tank 1.
5. **LIVE 1 (%)** — Percentage of used capacity of the live well 1.
6. **GREY 1 (%)** — Percentage of grey water in grey water tank 1.
7. **BLACK 1 (%)** — Percentage of black water in black water tank 1.
8. **BLACK 2(%)** — Percentage of black water in black water tank 2.

The combined graphical and digital percentage data item shown on the tanks page is unique to the tanks page and cannot be reproduced on other data pages. The tank data items can be changed or hidden.

Note:

The number of tanks displayed on the tanks page can only be changed by performing a factory reset and choosing a different number of tanks at the start up wizard.

25.11 Bidata and single data pages

The Bidata and single data pages are always available.



1. **Single data page** — By default the single data page displays the current time.
2. **Bidata page** — By default the bidata page displays SOG (Speed Over Ground) and depth.

The data items on the single data and bidata pages can be customized.

25.12 Generators page

When the display detects generators which transmit supported NMEA 2000 PGNs, a pre-configured generator page will be available in the Dashboard app.

Typically, a generator is connected to the display's SeaTalk NG / NMEA 2000 network, via the generator manufacturer's NMEA 2000 interface / gateway. If a gateway is used, ensure that it's running an appropriate software version — refer to the generator manufacturer.

The generator page displays data for the first 2 detected generators. **For the display of data for more than 2 generators, a Digital Control System (digital switching) solution is recommended.**

For information on compatible interfaces, refer to your generator's manufacturer.

Details of detected generators are available in the Generator configuration page. For details, refer to: [p.114 — Generator configuration](#)

Example page for single generator

The example provided below shows data provided by a Fischer Panda generator, connected to the display's SeaTalk NG / NMEA 2000 network via a Fischer Panda *Communication Interface FP-CAN to NMEA 2000*, (Part number: 0031409), running gateway software version 2v11 or later.

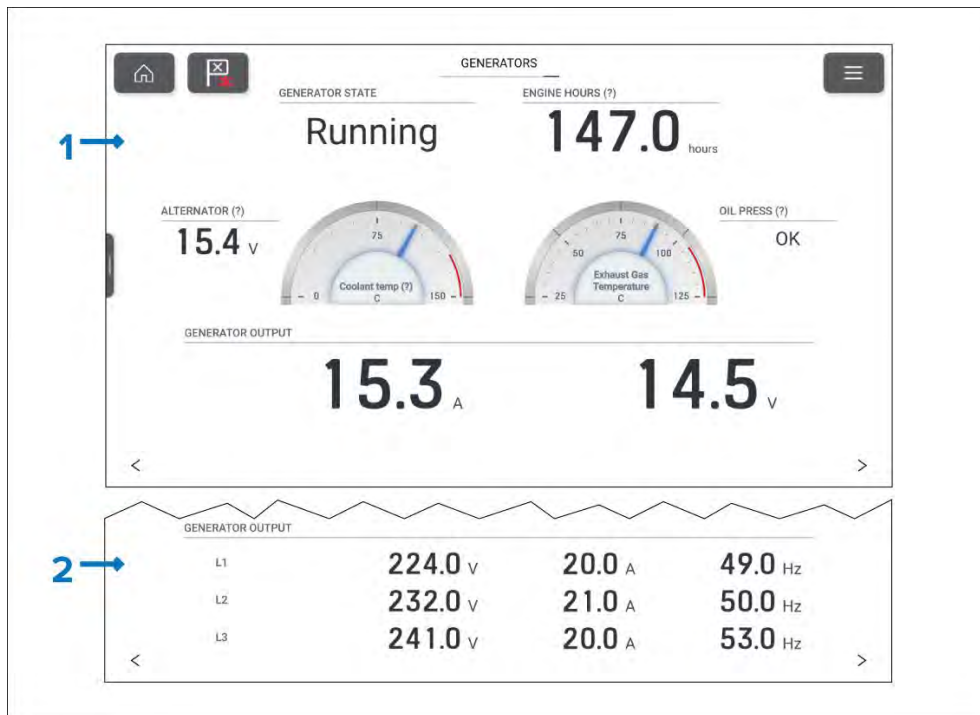

1. Example generator page for DC generator.
2. Example generator output data for a 3-phase AC generator.

The pre-configured generator page contains the following data items:

- Generator state (PGN 127514)
- Engine hours (PGN 127489)
- Alternator voltage (PGN 127489)
- Coolant temperature (PGN 127489)
- Exhaust gas temperature (PGN 130316)
- Oil pressure state (PGN 127489)

DC generators also include the following data items:

- Output voltage (PGN 127751)
- Output current (PGN 127751)

AC generators include the following data items for up to 3 phases:

- Output voltage (PGN 127747, PGN 127748, PGN 127749)
- Output current (PGN 127744, PGN 127745, PGN 127746)
- Output frequency (PGN 127747, PGN 127748, PGN 127749)

When more than one generator is detected, the generators page will show the data for the first 2 detected generators.

Example multiple generators

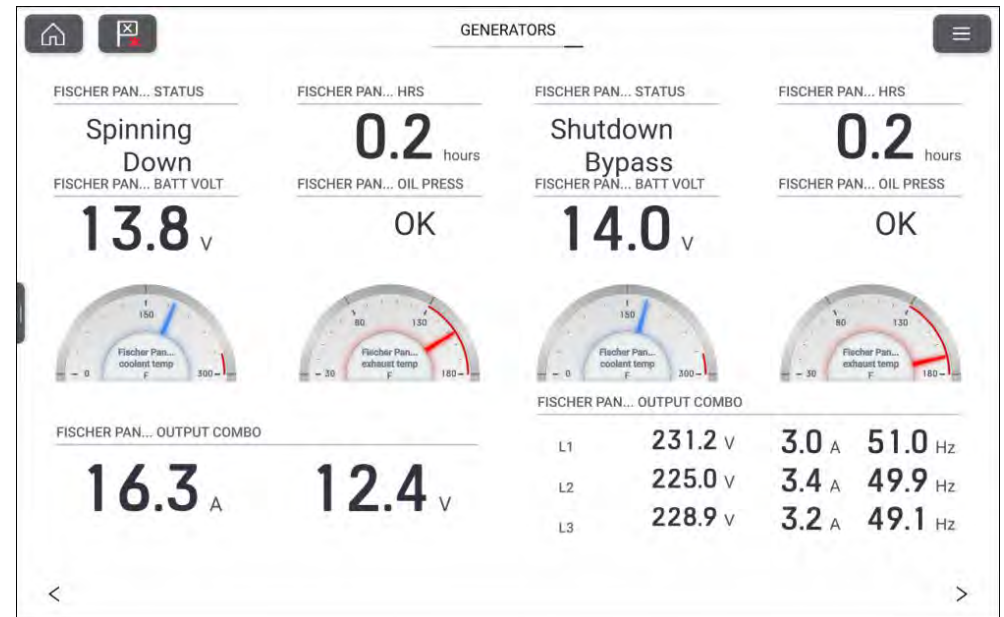

Generator data items can also be added to app data overlays, custom dashboard pages, and the sidebar. For a list of data items, refer to the Generator section of the data items list: [Generator data](#)

Generator start/stop

Generators that include a compatible remote controller can be started or stopped from the display.



When you select the *[Generator status]* data item from the Dashboard app or Sidebar, a pop-over option allows you to either *[Start]* or *[Stop]* the generator.

25.13 CZone plug and play

Digital switching pages for CZone® digital switching systems can be set up automatically in the Dashboard app using the CZone plug and play wizard.

Note:

- The Plug and play process requires a display interface to be present in the CZone configuration file for Raymarine MFDs.
- Only 1 display interface dipswitch number must be used to represent all Raymarine MFDs in the system.
- If the CZone configuration file contains only 1 display interface then the MFD will automatically select that assigned display interface dipswitch number.



Once the CZone plug and play wizard is completed successfully you will have access to all of the programmed circuits via the Dashboard app.

The wizard will create pages with up to 12 buttons per page (4 x 3), with a maximum number of 120 buttons. The buttons will be created in the circuit ID order from the configuration file.

Splitscreen page configurations are supported with 12 buttons per page (2 x 6).

Creating CZone digital switching pages automatically

When the Dashboard app detects CZone hardware and the system does not have an existing digital switching configuration installed, the CZone plug and play wizard is started.

Note:

The CZone plug and play wizard can be initiated at any time from the *[Pages]* settings menu *[Dashboard app > Menu > Settings > Pages]* by selecting *[Add page]* and then *[CZONE]* from the pop-over menu.

25.14 App menu

Settings for the Dashboard app are accessed by selecting the menu icon located on the top right of the app page.

From the main menu the following options are available:

- Data pages — You can switch to any page by selecting it from the main menu.
- *[Customize page]*— Select to customize the data items on the current page. For instructions refer to: [p.391 — Customizing a data item](#)
- *[Reset page]*— Select to reset the page's data items to default
- *[Reset min/max/ave]*— Select to reset minimum, maximum and average data items values (e.g.: minimum and maximum depth values).
- *[Settings]* icon — Select to open the Settings menu.

Settings menu

The Dashboard app settings menu is accessed by selecting the settings icon located at the bottom of the main menu. The settings menu is organized into full page menu's that are accessed by selecting the tabs at the top of the screen.

The following settings menus are available:

- *[Pages]*
- *[Circuits]*
- *[Units]*
- *[Advanced]*
- *[Page settings]*

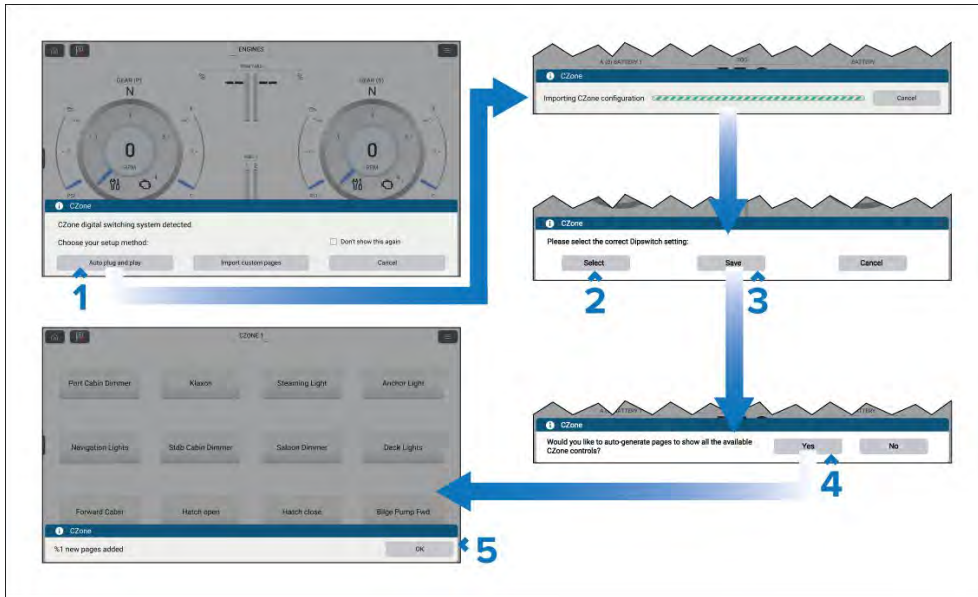

Note:

If you already have a CZone pages configured using the Raymarine graphics tool selecting *[Import custom pages]* will allow you to browse an inserted memory card for your custom pages file and import into the Dashboard app.

1. Select *[Auto plug and play]*.
The CZone configuration will be imported to the display.
2. Select the *[Select]* button and choose the dipswitch number as determined by your CZone configuration.
3. Select *[Save]*.
4. Select *[Yes]* to auto generate pages.
5. Select *[OK]*.

Pages settings menu

The *[Pages]* settings menu is used to customize the Dashboard app.

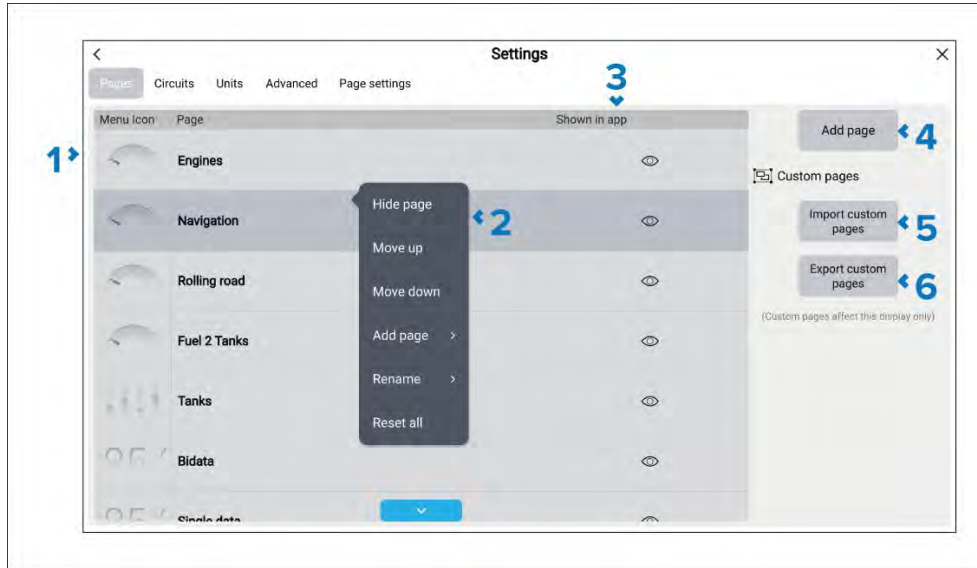

1. Pages list — A list of all pages that can be displayed in the Dashboard app.
2. Pop-over menu options — Selecting a page from the list opens the pop-over menu. The pop-over menu includes the following options:
 - *[Hide page]* / *[Show page]* — Select to show or hide the page.
 - *[Move up]* — Select to move the page up the list. The page order determines where the page will appear when cycling through pages using the arrows, and also determines the page's position in the main menu.
 - *[Move down]* — Select to move the page down the list. The page order determines where the page will appear when cycling through pages using the arrows, and also determines the page's position in the main menu.
 - *[Add page]* — Select to add a new custom page.
 - *[Delete page]* — Select to delete a custom page that you previously added.
 - *[Rename]* — Select to rename the page.
 - *[Reset all]* — Select to reset all data items on all pages to defaults.

3. Show in app — Identifies if the page is available in the Dashboard app. If the eye icon has a slash through it, the page is currently hidden.
4. *[Add page]* — Select to add a new custom page.
5. *[Import custom pages]* — Select to import a third-party digital switching page or configuration. For details, refer to: [Importing digital switching pages](#)
6. *[Export custom pages]* — Select to export a third-party digital switching page or configuration. For details, refer to: [Exporting digital switching pages](#)

Exporting digital switching pages

You can export third-party digital switching pages and configuration files so that they can be restored at a later date. Digital switching pages are not included in the standard “Import/export” process, which is used to backup user data and settings.

Important:

Each display may have a different digital switching configuration. You **MUST** perform the digital switching pages export on each display that has a digital switching configuration.

From the Dashboard app's *[Pages]* settings menu *[Menu > Settings > Pages]*:

1. Select *[Export custom pages]*.
2. Select the relevant card slot from the Info dialog.
3. Select *[Save]* to accept the default filename, or use the onscreen keyboard to enter your own filename and then select *[Save]*.

Important:

For systems with multiple displays that have different configurations, ensure that you name the export file appropriately so you can identify which display it came from.

4. Select *[OK]* to return to the Import/export page, or select *[Eject card]* to safely remove the memory card.

Importing digital switching pages

You can import third-party digital switching pages and configuration files from a memory card. Digital switching pages are not included in the standard “Import/export” process, which is used to restore user data and settings.

Important:

You should have a different configuration file for each display. You **MUST** import the correct configuration file for the display you’re currently using.

From the Dashboard app’s *[Pages]* settings menu *[Menu > Settings > Pages]*:

1. Select *[Import custom pages]*.
2. Select *[Yes]* to confirm import.
3. Browse your memory card for the correct configuration file for the display.
4. Select the configuration file.

The digital switching pages and configuration will be imported.

Circuits settings menu

The Circuits settings menu is used to view tripped circuits related to third-party digital switching configurations.

Units settings menu

The Units *[Menu]* is used to specify your preferred units of measure for data readings. The Units menu can be accessed from the Homescreen: *[Homescreen > Settings > Units]* or from the Dashboard app: *[Menu > Settings > Units]*.

Units

Measurement	Units
<i>[Distance units]</i>	<ul style="list-style-type: none">• <i>[NM & ft]</i>— Nautical miles & Feet• <i>[NM & m]</i>— Nautical miles & Meters• <i>[mi & ft]</i>— Miles & Feet• <i>[km & m]</i>— Kilometers and Meters• <i>[NM & yd]</i>— Nautical miles & Yards
<i>[Speed units]</i>	<ul style="list-style-type: none">• <i>[Kts]</i>— Knots• <i>[MPH]</i>— Mile per hour• <i>[KPH]</i>— Kilometers per hour
<i>[Depth units]</i>	<ul style="list-style-type: none">• <i>[Meters]</i>— m• <i>[Feet]</i>— ft• <i>[Fathoms]</i>— Fm
<i>[Temperature units]</i>	<ul style="list-style-type: none">• <i>[Celsius]</i>— C• <i>[Fahrenheit]</i>— F
<i>[Date format]</i>	<ul style="list-style-type: none">• MM : DD : YYYY• DD : MM : YYYY• MM : DD : YY• DD : MM : YY

Measurement	Units
<i>[Lat/Long format]</i>	<ul style="list-style-type: none"> • DD°MM'.MMM • DD:MM:SS • DD:MM:SS.S • DD:MM.MMM • DD°MM'SS • DD°MM.MMM'
<i>[Volume units]</i>	<ul style="list-style-type: none"> • <i>[US Gallons]</i>— Gsl • <i>[Imperial Gallons]</i>— Gal • <i>[Liters]</i>— Ltr
<i>[Economy units]</i>	<ul style="list-style-type: none"> • Distance per Volume • Volume per Distance • Liters per 100 km
<i>[Wind speed units]</i>	<ul style="list-style-type: none"> • <i>[Knots]</i>— kts • <i>[Meters per Second]</i>— m/s
<i>[Pressure units]</i>	<ul style="list-style-type: none"> • <i>[Bar]</i> • <i>[PSI]</i> • <i>[Kilopascals]</i>— KPa
<i>[Time format]</i>	<ul style="list-style-type: none"> • 12hr • 24hr

Bearing and variation

Menu item/description	Options
<i>[Bearing mode]</i> Determines how bearing and heading data is displayed.	<ul style="list-style-type: none"> • True • Magnetic
<i>[System Datum]</i> Determines the datum used by your display. This should be set to the same datum used by your paper charts.	List of available datums.
<i>[Variation]</i> When set to <i>[Auto]</i> the display will automatically compensate for the naturally-occurring offset of the Earth's magnetic field.	<ul style="list-style-type: none"> • Auto • Manual
<i>[Manual variation]</i> When <i>[Variation]</i> is set to <i>[Manual]</i> , you can specify an offset.	30° W to 30° E

Time differentials

Time differentials are used for Loran positioning.

Measurement	Units
<i>[Chain]</i>	List of available Loran 'master' chains.
<i>[Slave 1]</i> Cannot be set to the same as Slave 2	Filtered list of slave stations based on selected chain..
<i>[Slave 2]</i> Cannot be set to the same as Slave 1	Filtered list of slave stations based on selected chain..
<i>[ASF 1]</i> Additional Secondary Factors	-9.9 to +9.9
<i>[ASF 2]</i> Additional Secondary Factors	-9.9 to +9.9

Engine RPM settings

The advanced settings menu allows you to specify some advanced settings for engine RPM dials and data.

Engine RPM settings

The following engine RPM settings are available:

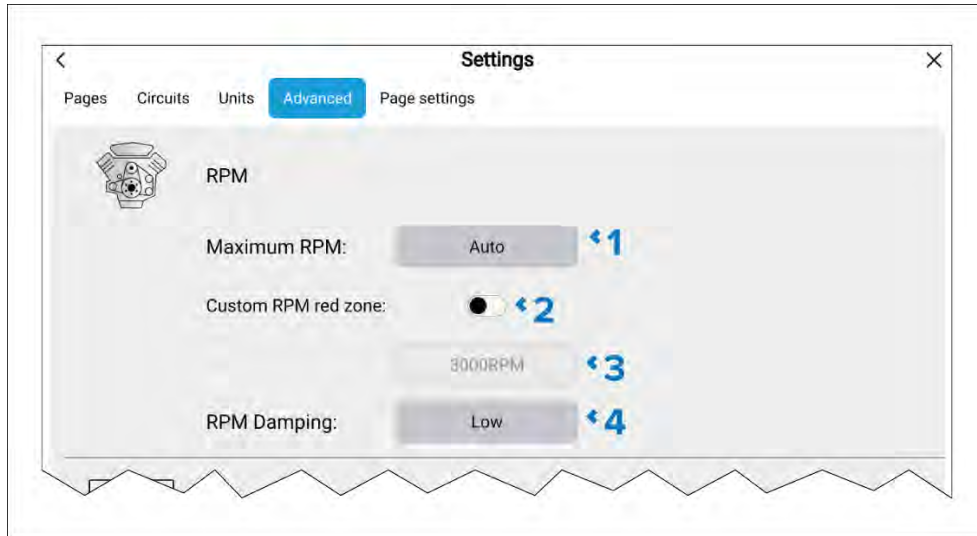

1. *[Maximum RPM]*— Select to specify a maximum RPM for your engine dials, or allow the system to automatically configure the Maximum RPM.
2. *[Custom RPM red zone]*— Enable toggle to allow selection of a custom red zone for engine RPM dials.
3. Custom RPM red zone field — With *[Custom RPM red zone]* enabled you can specify the RPM at which the red zone begins.
4. — You can specify how sensitive to change the engine RPM read out is. The RPM damping can be *[Off]*, *[Low]* or *[High]*.

Data response settings

The advanced settings menu allows you to specify how responsive certain data items are to change i.e.: the rate at which the data is updated.

The following data response (damping) settings are available:

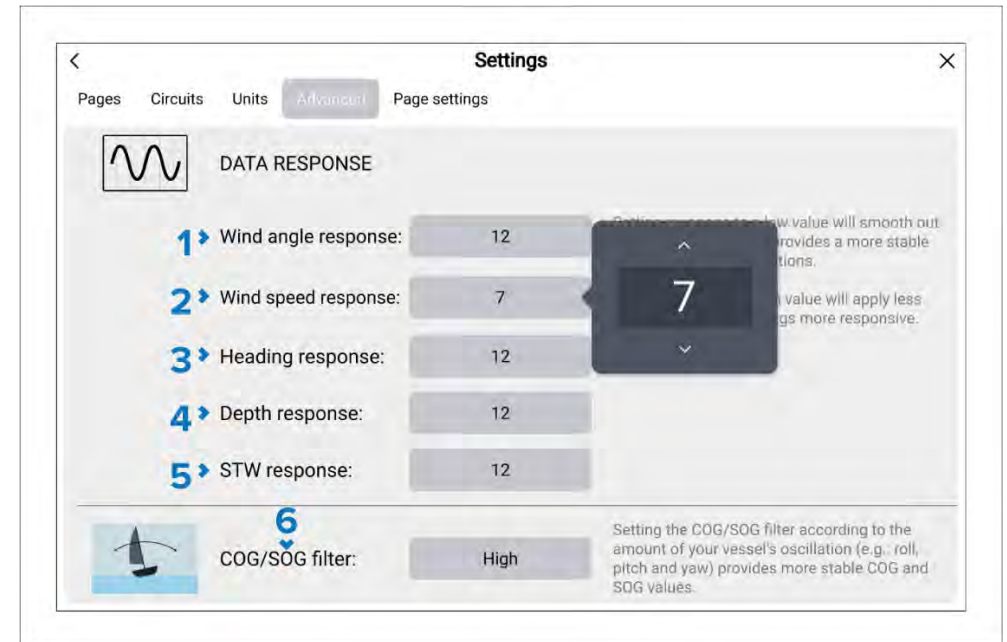

1. *[Wind angle response]*(applies to data received from a wind transducer).
2. *[Wind speed response]*(applies to data received from a wind transducer).
3. *[Heading response]*(applies to data received from a Heading sensor).
4. *[Depth response]*(applies to data received from a Depth transducer).
5. *[STW response]*(applies to speed data received from a Paddlewheel speed transducer).
6. *[COG/SOG filter]*(applies to COG and SOG data received from a GNSS (GPS) receiver).

The data response settings can be set from *1* to *15*, with *12* being the default. The higher the value, the faster the update rate. The data response settings will apply to the displayed data item in the Dashboard app, Sidebars and Data overlays.

The COG/SOG filter settings are: *Low*, *Medium* and *High*.

Page settings menu

The page settings menu allows you to configure data overlays and, when applicable, adjust the position of the split on pages containing multiple apps.

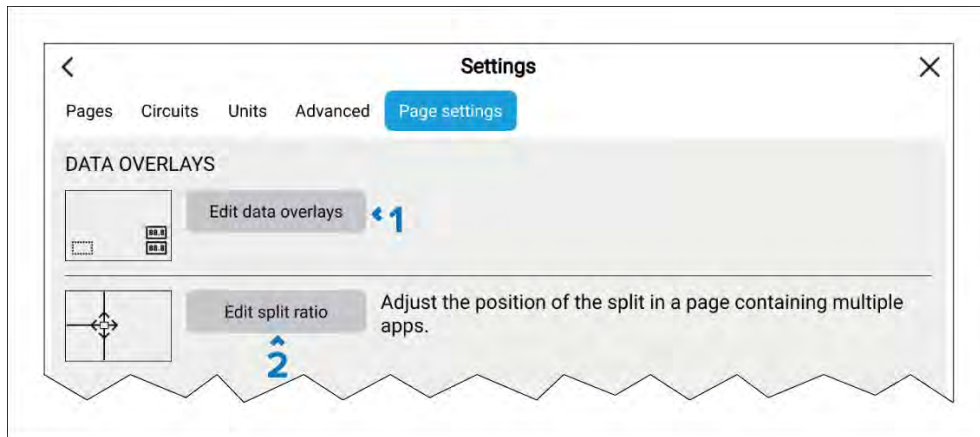

1. *[Edit data overlays]* Fore details refer to: [p.49 – Data overlays](#)
2. *[Edit split ratio]* Fore details refer to: [p.96 – Editing the splitscreen ratio](#)

CHAPTER 26: MERCURY APP

CHAPTER CONTENTS

- 26.1 Mercury app overview — page 414
- 26.2 Mercury sidebar overview — page 418
- 26.3 SkyHook mode — page 419
- 26.4 Autopilot control — page 420
- 26.5 Active Trim — page 423
- 26.6 Troll control — page 424
- 26.7 Cruise control — page 425
- 26.8 Sport exhaust — page 426
- 26.9 Steering angle indicator — page 426
- 26.10 Engine data page — page 426
- 26.11 Faults — page 427

26.1 Mercury app overview

Engine data from Mercury engines can be displayed in the Mercury app when the display is connected to the same SeaTalkng® / NMEA 2000 backbone as the Mercury engine gateway.

Note:

It is recommended that your Mercury Smartcraft connect gateway is upgraded to the latest version of software by a Mercury dealer.

Note:

- A Mercury app page icon will be available on the Homescreen when *[Mercury]* is selected as the Engine manufacturer during the display's initial start up wizard.
- The Mercury app can also be made available by changing the Engine manufacturer setting to *[Mercury]* and manually adding a Mercury app page icon to the Homescreen.
 - The Engine manufacturer setting is located in the display's Boat details settings: *[Homescreen > Settings > Boat details > Engine manufacturer:]*.
 - To create a Mercury app page icon manually, refer to: [p.95 — Creating an app page](#)

Engine data for up to 4 engines can be displayed. The number of engines that data is displayed for is determined by the number of engines specified in the display's boat details settings menu: *[Homescreen > Settings > Boat details > Num of engine:]*.

Data for port engine(s) is displayed on the left dial, and data for starboard engine(s) is displayed on the right dial. In 3 engine systems, the right dial is also used to display data for the Center engine.

In 3 and 4 engine configurations, the RPM dial and transmission graphics are dynamic and will switch between engines under different conditions.

Fullscreen app page

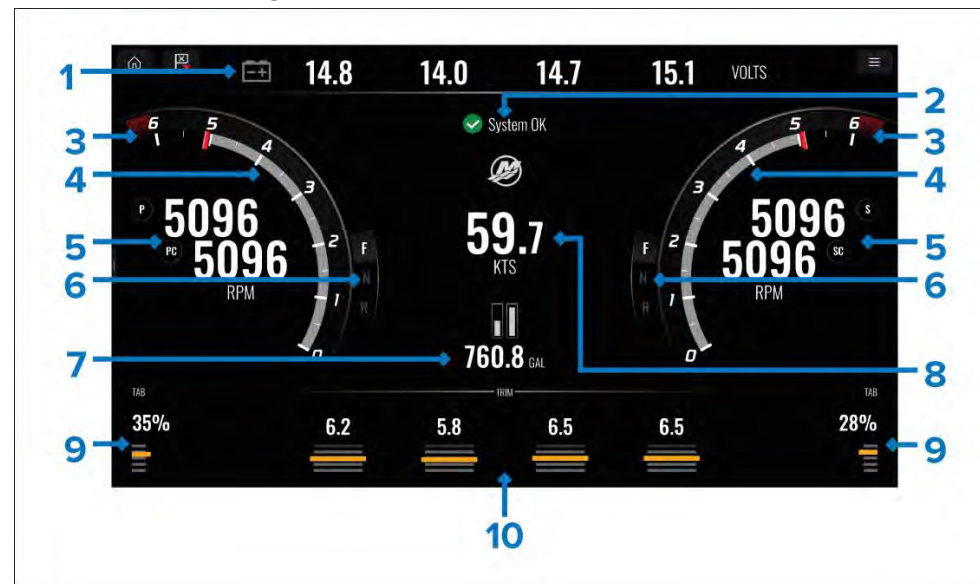

1. Engine alternator voltage — In the fullscreen app the engine alternator voltage data items can be changed to show steering angle indicator instead.
2. System status — Engine status and start up sequence is displayed.
3. Dynamic engine RPM red zone — The RPM red zone is determined automatically based on engine type. When an engine reaches the RPM red zone, the red zone color will change from dark red to bright red.
4. Dynamic engine RPM indicator— Indicates the engine's current RPM.
5. Engine RPM value — Displays current RPM values.
6. Dynamic transmission status — Indicates the current transmission gear.
7. Fuel tanks levels and total fuel — When a tank reaches 20% of its capacity, the level indicator will turn red. Up to 5 fuel tanks are supported.
8. Current vessel speed (Speed Through Water).
9. Tab position — Indicates vessel tab position as a percentage, with 0% being fully trimmed up (stored), and 100% fully trimmed down.
10. Engine trim — Indicates the engine trim position. Numeric values will be displayed between 1 and 10. Although the highest numeric value is 25, values above 10 are not displayed and are instead replaced by an icon, to indicate that the boat is being trailered.

The Mercury app can also be displayed in a splitscreen app page using either half screen portrait or landscape panes. When viewed in splitscreen app pages the page layout will be different.

Engine notifications

Engine notifications such as alarms and warnings will be shown on the display screen. Refer to: [p.416 — Engine warning messages](#)



Warning: Position holding/trolling features

A rotating propeller, moving vessel, or a device attached to a moving vessel can cause serious injury or death to people in the water. The MFD includes features which can control vessel engines and/or devices which can move the vessel. Stop the engines immediately whenever anyone is in the water near the vessel.

Mercury features

Raymarine's Mercury integration allows Raymarine displays running LightHouse™ version 4.1 or greater to replace the dedicated VesselView display, when it is connected to a SmartCraft connect gateway.

Supported features:

- Support for up to 4 engines
- Mercury app
- Engine data
- Fault code notifications
- Software update
- Bluetooth and Wi-Fi (SmartCraft Connect connection to SmartCraft Manager mobile app)
- Fuel tank level
- Skyhook (Activated using joystick)
- Engine fluid levels V12/V8/V6
- Steering angle
- Cruise control
- Troll control
- Autopilot control: Autoheading (LH4.3 or greater)

- Autopilot control: Active route (LH4.3 or greater)
- Active Trim control (LH4.3 or greater)
- Primary helm display selection (LH4.3 or greater)
- SkyHook, BowHook, DriftHook control (LH4.6 or greater)

Splitscreen app pages

The Mercury app can be viewed in a horizontal or vertical splitscreen app page.

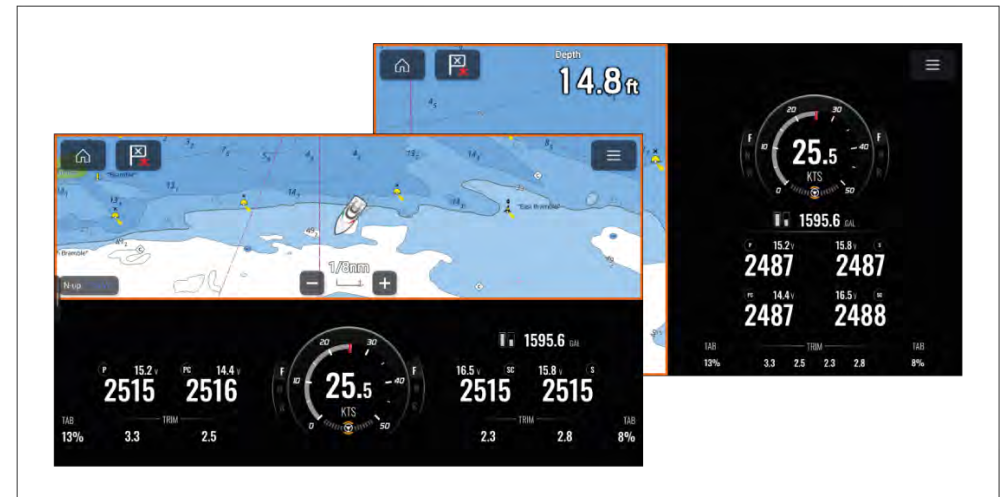

The layout of data on splitscreen pages differs from the fullscreen pages to accommodate the smaller page size.

Changing alternator voltage to steering angle indicator

By default, the fullscreen Mercury app page displays engine alternator voltage at the top of the page; this can be changed to display the steering angle indicator instead.

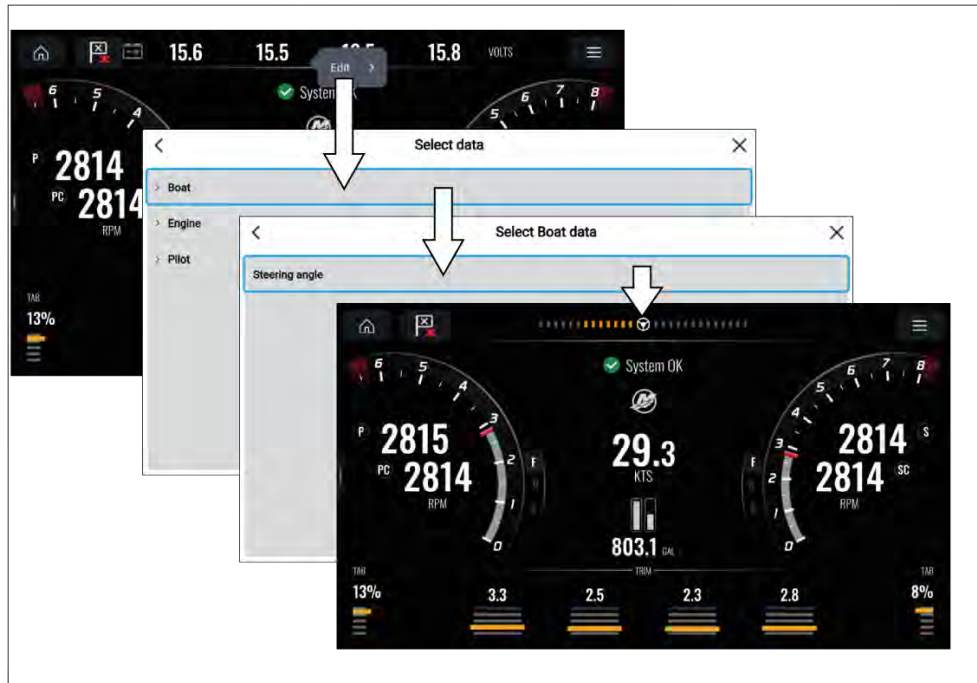

1. Select and hold the alternator voltage area located at the top of the screen.
2. Select *[Edit]* from the pop-over menu.
3. To display the steering angle indicator, select *[Boat > Steering angle]* or *[Pilot > Steering angle]*

You can change back to displaying engine alternator voltage by selecting: [Engine > All Engines > Alternator].

The data item can also be changed using the Mercury app menu: *[Menu > Customize page].*

System status

The System status is displayed in the center of the page.

When the system is started a scan is performed after which **System OK** is displayed.

No Communication is displayed if the engines are turned off or engine data cannot be detected.

If the system is restarted after a brief time the system scan is not performed.

Engine warning messages

Engine alarms, warnings and notifications will be shown on the display as they are triggered.

Engine warning messages are color-coded to signify their severity:

Alarms

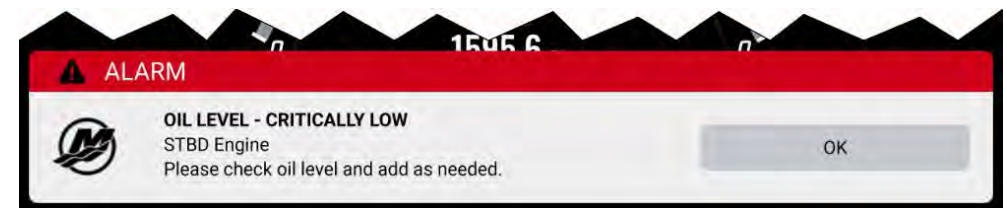

Alarms are **red** — Alarms are used to signify that immediate action is required due to a potential or immediate danger or damage. Alarms are accompanied by an audible tone. The alarm message continues to be displayed and the audible tone will continue to sound until the message is acknowledged, or the conditions that triggered the alarm are no longer present. Acknowledged alarms may remain active whilst the alarm condition persists, but will not trigger further onscreen or audible notifications.

Alarms are listed in the Fault code history which can be viewed from the app menu: *[Menu > Settings > Fault code history].*

Warnings

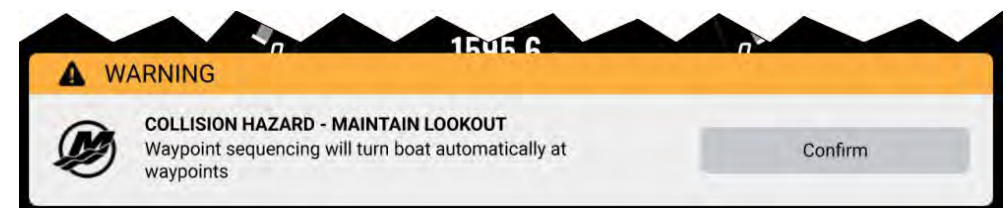

Warnings are **Orange** — Warnings are used to signify that there has been a change in situation requiring your attention. Warnings are accompanied by an audible tone. The alarm message continues to be displayed and the audible tone will continue to sound until the message is acknowledged, or the conditions that triggered the warning are no longer present. Acknowledged warnings may remain active whilst the warning condition persists, but will not trigger further onscreen or audible messages.

Notices



Notices are **Blue** — Notices are used to provide information requiring user acknowledgement. Notices are not accompanied by an audible tone.

Mercury SmartCraft helm grouping

Mercury SmartCraft integration is only available on displays assigned to display groups *Helm 1*, *Helm 2*, *Helm 3* and *Helm 4*.

Helm grouping should be configured during installation. If required the helm grouping can be changed from the *[This display]* menu: *[Homescreen > Settings > This Display > Display group:]*.

Helm grouping

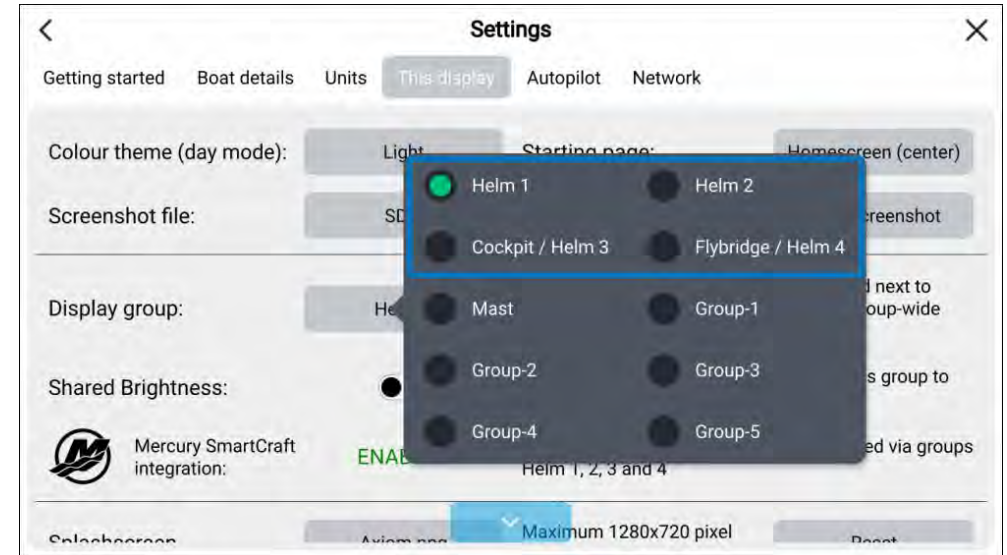

Displays that are in the same area should be in the same group.

Primary display selection

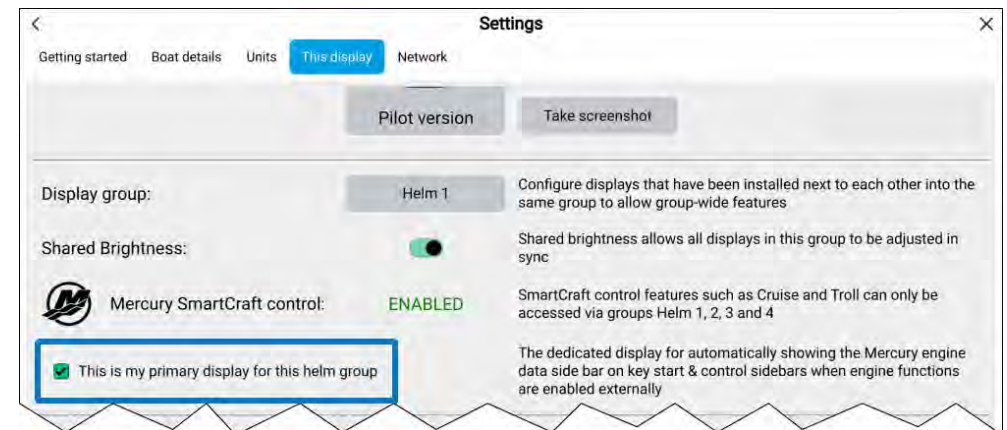

When more than 1 display is in a group then a primary display must be selected. On the selected primary display the relevant Mercury sidebar will automatically be displayed on engine start and when a Mercury feature is activated.

To assign the primary display, select the *[This is my primary display for this helm group]* from the *[This display]* settings menu: *[Homescreen > Settings > This Display]*.

Information messages

When integrated with a Mercury SmartCraft system the display supports standard information messages transmitted by the SmartCraft system.

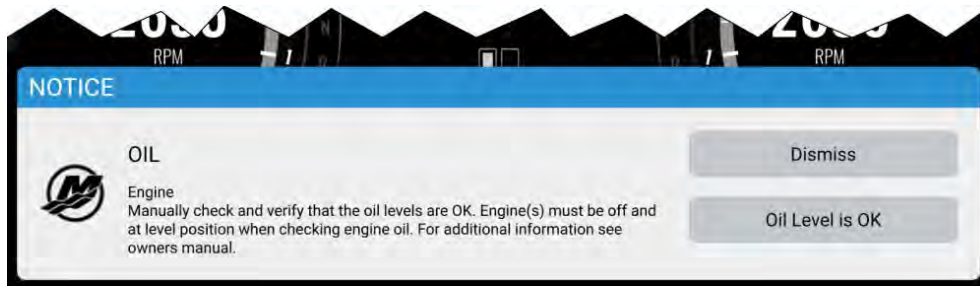

26.2 Mercury sidebar overview

The Mercury sidebar is available in all MFD apps, and provides quick access to Mercury features and engine data.

Selecting the Mercury icon displays additional icons representing the various Mercury sidebars available. Selecting a Mercury sidebar icon will display the relevant sidebar.

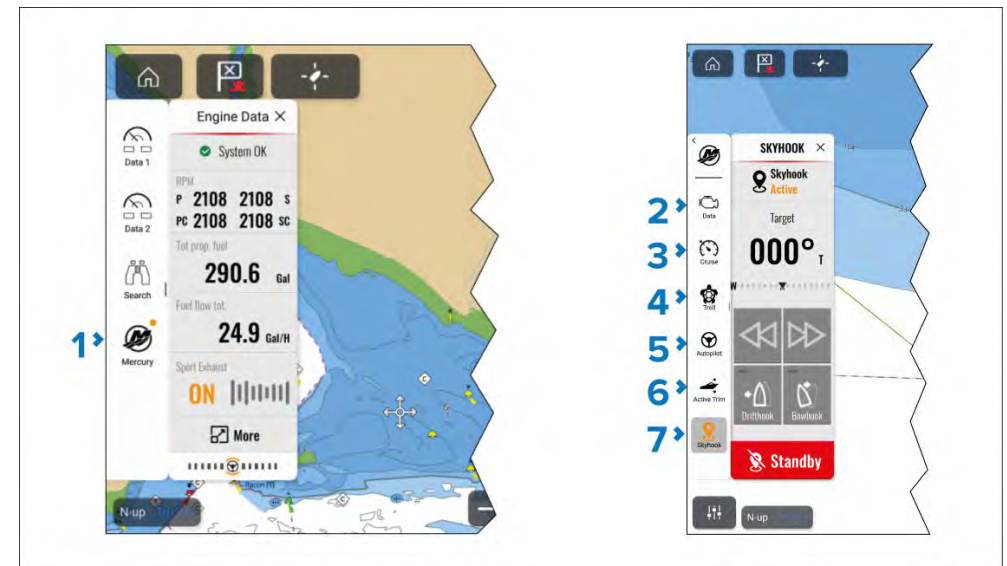

1. *[Mercury]* sidebar.
2. *[Data]* sidebar.
3. *[Cruise control]* sidebar.
4. *[Troll control]* sidebar.
5. *[Autopilot]* sidebar.
6. *[Active Trim]* sidebar.
7. *[SkyHook]* sidebar

An amber circle in the top right of the Mercury icon (as shown in (1) in the screenshot shown above) indicates an active control feature, such as *[Cruise control]* or *[Troll control]*. The relevant sidebar icon will also be colored amber, as shown in (3), (5) and (6) in the screenshot shown above.

26.3 SkyHook mode

SkyHook is a virtual digital anchor which uses GNSS (GPS) data to maintain a boat's position. SkyHook engages the engines or drives in a number of directions and speeds to compensate for the effects of wind and current on the vessel.

The SkyHook feature can be controlled from the [SkyHook] Mercury sidebar, which also allows you to switch between the [SkyHook], [BowHook] and [DriftHook] features.

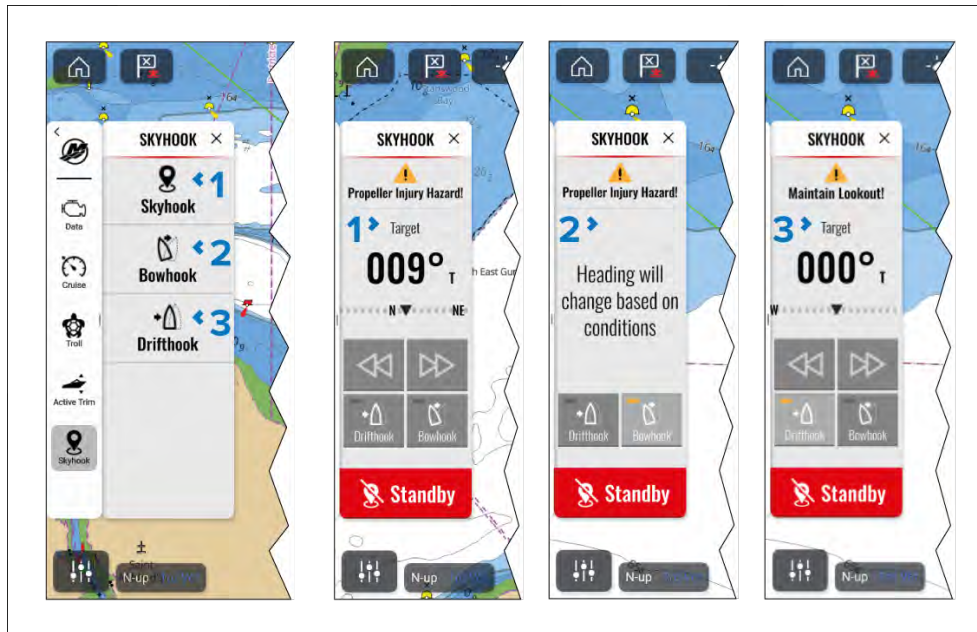

1. [SkyHook] sidebar.
2. [BowHook] sidebar.
3. [DriftHook] sidebar.

When [SkyHook] is selected, a warning is triggered alerting the operator to ensure that there are no swimmers in the vicinity of the vessel.

Important:

- Before [SkyHook] is engaged you must inform passengers how the feature works, and that they must stay out of the water.
- After [SkyHook] is engaged you must remain at the helm and maintain a vigilant watch, so that [SkyHook] can be quickly deactivated if someone goes in the water.

Once engaged, [SkyHook] remains active until it is disengaged

The [SkyHook] sidebar includes the following information and controls:

SkyHook mode

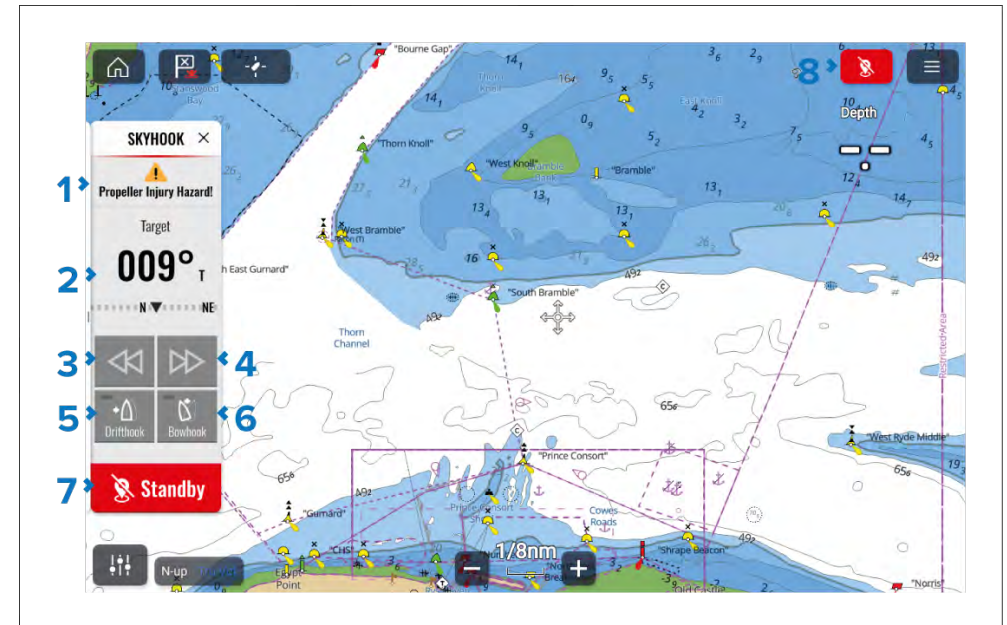

1. Whilst engaged, the status switches between “SkyHook active” and “Propeller injury hazard”.
2. The target heading is displayed.
3. [Left arrow] button — Selecting the [Left arrow] decreases the locked heading in 1° increments.
4. [Right arrow] button — Selecting the [Right arrow] increases the locked heading in 1° increments.

5. *[Drifthook]* button — Selecting *[Drifthook]* engages *[DriftHook]* mode.
6. *[Bowhook]* button — Selecting *[Bowhook]* engages *[BowHook]* mode.
7. *[Standby]* button — Selecting *[Standby]* disengages *[Skyhook]* mode.
8. *[Skyhook]* icon — Selecting the *[Standby]* icon located in the top right of the Chart app will also disengage *[SkyHook]* mode.

BowHook mode

In BowHook mode, the vessel's reported heading will change based on the prevailing wind and tide conditions, even while the vessel maintains its current position.



DriftHook mode

In DriftHook mode, the vessel's reported heading will change based on the prevailing wind and tide conditions, even while the vessel maintains its current position. However, unlike the similar BowHook mode, DriftHook mode additionally allows you to adjust the heading manually in increments.



26.4 Autopilot control

Compatible Mercury® autopilots connected to the SmartCraft® connect gateways via the SmartCraft® bus can be integrated with the display so that the autopilot can be controlled from the display. On these systems the autopilot control will be available.

Autopilot controls can be accessed from the Autopilot sidebar. Performing a *[Goto]* or *[Follow route]* in the Chart app will also provide options to engage your autopilot.

Autopilot sidebar selection

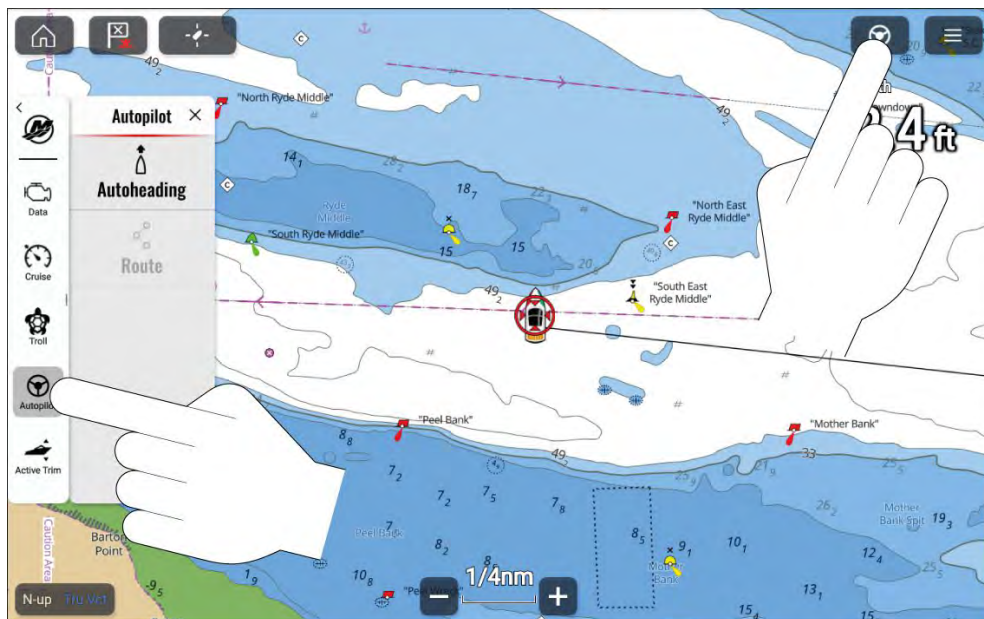

When the autopilot is engaged, the Autopilot sidebar is displayed automatically. With the autopilot disengaged (i.e.: in Standby mode), you can display the Autopilot sidebar by selecting the Autopilot icon located on the top right of the screen, or by manually selecting the Autopilot sidebar icon from the Mercury sidebar options.

Autopilot sidebar states



1. With the autopilot in standby, the Autopilot sidebar has *[Autoheading]* or *[Route]* options. You can select *[Autoheading]* to engage the autopilot and maintain the current heading.. If you are already following a route, you can select *[Route]* to engage the autopilot in Route mode. In Route mode, the boat will follow the route and when a waypoint is reached the boat will automatically proceed to the next waypoint in the route.
2. **Autoheading** — When Autoheading is engaged, the sidebar displays the current target heading and provide controls to increase and decrease the heading angle in 1° or 10° increments.
3. **Route mode** — In Route mode, the sidebar displays navigation data and provides controls to switch to *[Autoheading]*, advance to the next waypoint (*[Advance wpt.]*), or restart the “route follow” command (*[Restart here]*).

Enabling and disabling Mercury® autopilot integration

Integration with Mercury® autopilots can be enabled and disable from the Autopilot settings menu.

From the *[Homescreen]*:

1. Select *[Settings]*.

2. Select *[Autopilot]*.
3. Select the *[Control pilot from chartplotter(s):]* toggle switch.

When disabled the autopilot control of Mercury® engines will not be available.



Warning: Maintain a permanent watch

Always maintain a permanent watch, this will allow you to respond to situations as they develop. Failure to maintain a permanent watch puts yourself, your vessel and others at serious risk of harm.



Warning: Autopilot usage

Autopilots navigate a preset course and do NOT respond to hazards automatically. The operator must remain at the helm at all times and be ready to avoid hazards and warn passengers of course changes.

Engaging Autoheading

Autoheading allows the boat to automatically maintain a heading while underway.

Important:

- The operator **must** remain at the helm **at all times**. Autoheading is NOT designed to allow unattended operation of the boat.
- It is the responsibility of the operator to ensure that the passage is safe to navigate **before** engaging the autopilot.

1. Ensure that the engines are running.
2. Place at least one running engine in forward gear.

Important:

Autoheading does not function with Electronic Remote Control (ERC) levers in neutral or reverse.

3. Steer the boat to the desired heading.
4. Engage Autoheading by:

- Selecting the *[Autoheading]* button on the autopilot sidebar and then selecting *[Engage Autopilot]*.
- Pressing the physical *[Pilot]* button on an Axiom® 2 Pro display or pressing and holding the physical *[STBY (Auto)]* button on an Axiom® Pro display or RMK remote.

5. Adjustments to the heading can be made in 1° and 10° increments using the controls on the Autopilot sidebar.

Engaging Route mode

Route mode allows you to automatically navigate a preset route saved on your display.

Important:

- When following a route, Route mode will automatically turn the boat upon waypoint arrival to the next waypoint in the route.
- The operator **must** remain at the helm **at all times**. Route mode is NOT designed to allow unattended operation of the boat.
- It is the responsibility of the operator to ensure that the route is safe to follow **before** engaging the autopilot.
- It is also the responsibility of the operator to ensure that, when a waypoint arrival circle is reached, the next turn is safe to perform.

1. Ensure that the engines are running.
2. Place at least one running engine in forward gear.

Important:

Route mode does not function with Electronic Remote Control (ERC) levers in neutral or reverse.

3. Steer the boat in the direction of the first waypoint.
4. Engage Route mode by:
 - Selecting *[Follow route]* from the Route context menu and then selecting *[Engage Autopilot]* from the notification dialog.

- Selecting the desired location or waypoint in the Chart app, selecting *[Goto]* from the Chart context menu, and then selecting *[Engage Autopilot]* from the notification dialog.
5. When the final destination waypoint or the last waypoint in a route has been reached, a warning is displayed giving you the following options:
- Select *[Maintain Heading]* to enter Autoheading mode.
 - Select *[Standby]* to disengage the autopilot.

Disengage the autopilot (Standby)

The autopilot can be disengaged i.e.: put into Standby mode at any time.

Sidebar and app screen

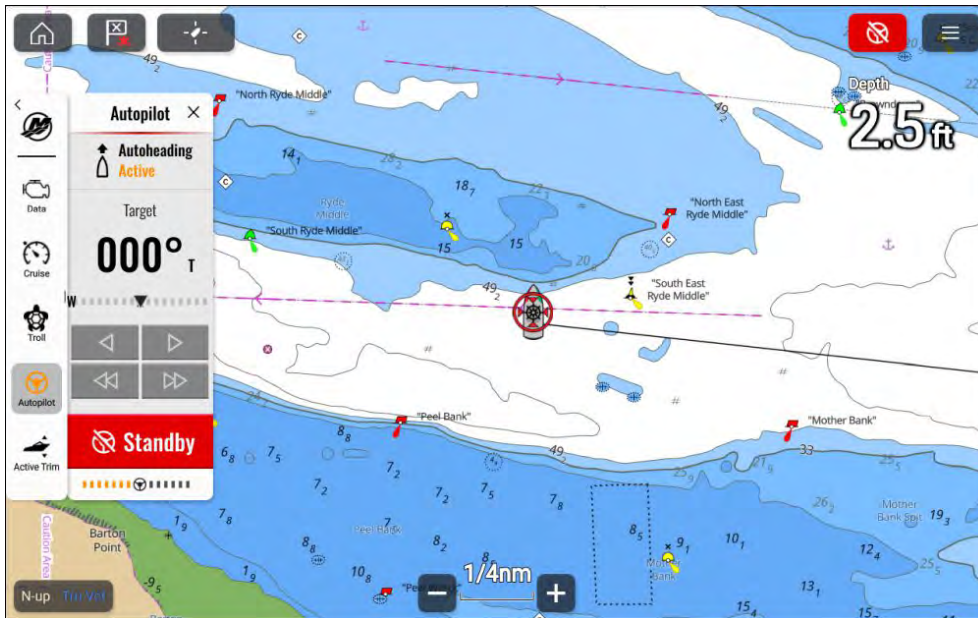

Shortcuts menu

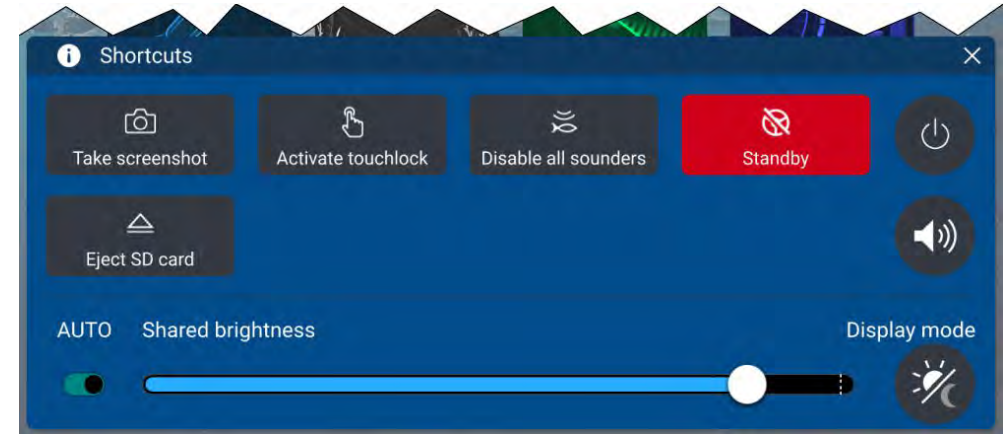

The autopilot can be placed in Standby by:

- selecting the red Autopilot icon located on the top right of the screen and then selecting *[Standby]*.
- selecting the *[Standby]* button from the Autopilot sidebar and then selecting *[Standby]*.
- selecting the *[Standby]* icon from the Shortcuts menu.
- pressing the physical *[Standby]* on an Axiom® 2 Pro display or pressing the physical *[STBY (Auto)]* button on an Axiom® Pro display or RMK remote.

26.5 Active Trim

If your Mercury system supports it, Active Trim can be set up and controlled from the display. Active Trim is Mercury Marine's patented GPS-based automatic trim system. This intuitive, hands-free system continually adjusts engine or drive trim for changes in operating conditions to improve performance, fuel economy, and ease of operation.

Active Trim responds to boat maneuvers with precision, and delivers a better overall driving experience. For further details on Active Trim, refer to your Mercury operator's guide.

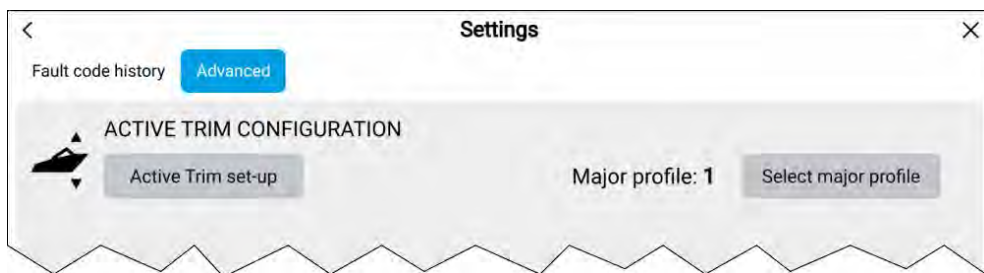

Active Trim can be configured from the Mercury app's *[Advanced]* settings menu: *[Menu > Settings > Advanced]*. From this menu, Active Trim can also be configured by selecting *[Configure]* from the Active Trim sidebar.

The Active Trim sidebar is accessed from the Mercury sidebar options.

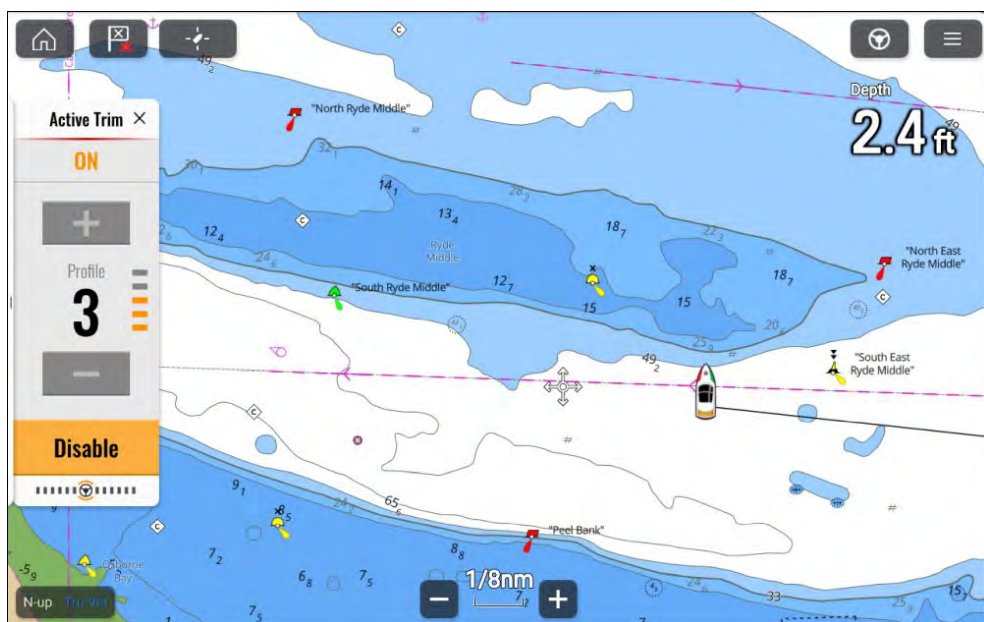

Once configured, Active Trim can be enabled and disabled from the Active Trim sidebar. You can also switch the Running profiles from this sidebar.

Setting up Active Trim

To configure Active Trim from the display, follow the steps below:

Whilst Active Trim is being configured, any other displays in the same helm group will show the progress in the Active Trim sidebar.

Note:

If Active Trim has previously been configured, ensure that the Running profile in the Active Trim sidebar is set to **3** before you begin.

1. Start the engines and place in neutral gear.
2. Select *[Active Trim set-up]* from the Mercury app's *[Advanced]* settings menu: *[Menu > Settings > Advanced]*, or select *[Configure]* from the Active Trim sidebar.
3. Trim all engines to the fully up position.
4. Select *[Next]*.
5. Trim all engines to the fully down position.
6. Select *[Next]*.
7. Select *[Next]*.
8. Increase the boat speed to cruising speed.
9. Increase the major profile until the boat begins to porpoise, then decrease by one profile.

Once configured, you can adjust Active Trim performance by increasing or decreasing the Running profile from the Active Trim sidebar.

If required, the major profile can be changed at any time, by selecting the *[Select major profile]* button from the *[Advanced]* menu.

26.6 Troll control

On supported engines and outboards the troll control feature will be available on the Mercury sidebar.

Controls for the troll feature are available in the Mercury Troll sidebar. The troll feature enables you to select a specific low value RPM that your engines will maintain until troll is disabled. The RPM speed can be adjusted in 10 RPM increments using the *[+]*(plus) and *[-]*(minus) buttons on the sidebar.

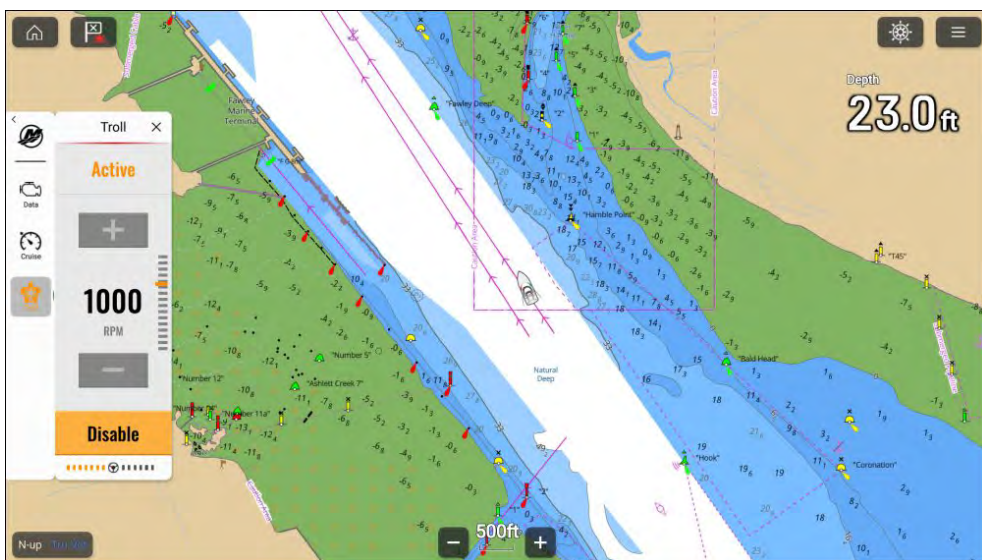

Enabling troll control

Troll control is enabled from the troll sidebar. For the troll controls to be available the engines must be in forward gear and idle.

1. Place the engines in forward gear and ensure they are idle.
2. If no sidebar is displayed, swipe your finger from the left edge of the screen to the middle.
3. Select the Mercury icon.
4. Select the Troll icon.
5. Use the **[+]**(Plus) and **[-]**(Minus) buttons to adjust your desired engine RPM.

*The **[+]** (Plus) and **[-]** (Minus) buttons will be deactivated if the minimum or maximum value has been selected.*

6. Select **[Enable]**.

Your engine RPM will now increase to the set level.

If troll is active the troll sidebar icon will be colored amber. Hiding the sidebar will not affect troll operation.

When enabled you can adjust the engines RPM using the **[+]**(Plus) and **[-]**(Minus) buttons.

Cancelling troll control

To regain manual throttle control troll mode must be cancelled.

Troll control mode can be cancelled by:

- Placing handles in neutral position, or
- Selecting **[Disable]** from the troll sidebar.

26.7 Cruise control

On supported engines and outboards the cruise feature will be available on the Mercury sidebar.

Controls for the cruise feature are available in the Mercury Cruise sidebar. The cruise feature enables you to select a specific RPM that your engines will maintain until cruise is disabled. The RPM speed can be adjusted in 50 RPM increments using the **[+]**(plus) and **[-]**(minus) buttons on the sidebar.

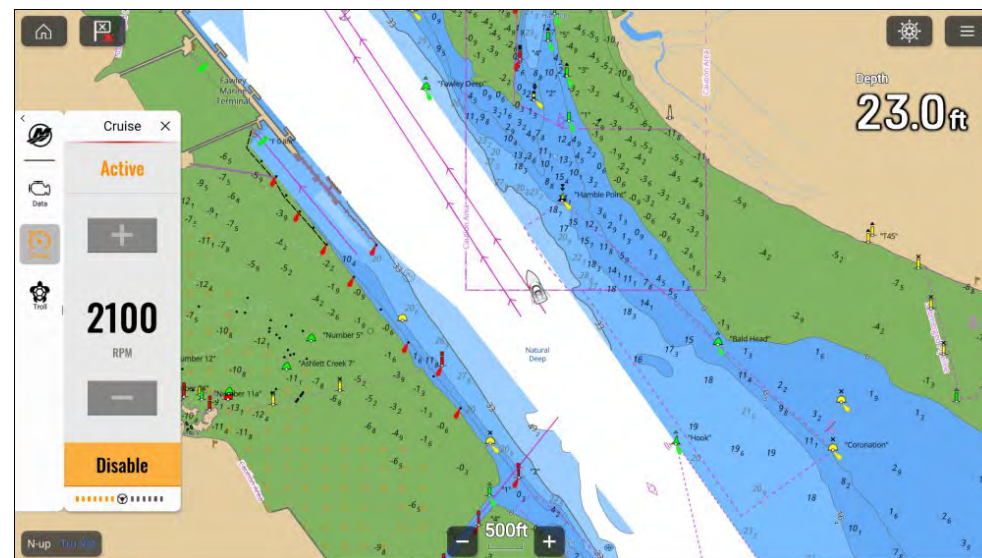

Enabling cruise control

Cruise control is enabled from the cruise sidebar.

1. If no sidebar is displayed, swipe your finger from the left edge of the screen to the middle.
2. Select the Mercury icon.

3. Select the Cruise icon.
4. Use the *[+]*(Plus) and *[-]*(Minus) buttons to adjust your desired engine RPM.
5. Select *[Enable]*.
6. Place the remote control handles in the forward gear position, and place the handles in the wide-open throttle position.

Your engine RPM will now increase to the set level.

If cruise is active the cruise sidebar icon will be colored amber. Hiding the sidebar will not affect cruise operation.

In cruise mode you can adjust the desired RPM using the *[+]*(Plus) and *[-]*(Minus) buttons.

Cancelling cruise control

To regain manual throttle control cruise mode must be cancelled.

Cruise control mode can be cancelled by selecting *[Disable]* from the cruise sidebar.

26.8 Sport exhaust

On supported outboards the option to switch the sport exhaust feature on and off will be available on the Mercury engine data sidebar.

The sport exhaust feature allows you to change the sound of the outboard idle relief exhaust volume. Enabling the sport exhaust feature opens an exhaust passage, allowing a more deep exhaust sound.

Note:

Mercury Smartcraft Connect Gateway software release 3 or greater is required.

26.9 Steering angle indicator

The steering angle indicator provides an onscreen indication of the steering position.

The Steering angle indicator is available in the Mercury app and the Mercury sidebar.

Steering angle indicator locations



1. Location in fullscreen app page.
2. Location in Mercury sidebar.
3. Location in splitscreen app page.

The Steering angle indicator is non-linear and is more sensitive at lower steering angles.

Note:

The steering angle indicator is disabled when a Mercury joystick is active.

26.10 Engine data page

The Mercury engine data page displays various engine related data for your Mercury engines.

The Engine data page can be accessed from the Mercury app: *[Menu > Engine data]* or from the Mercury sidebar by selecting *[More]*.

	Port	Starboard
RPM	4188	4188
Oil level	Good	Good
Transmission Fluid Level	Good	Good
Engine Hours	0.3 hours	0.3 hours
Battery	12.5 v	12.1 v
Trim	20 %	11 %

The following is the full list of data that is available for each configured engine.

- RPM
- *Oil level
- *Transmission fluid level
- Engine hours
- Battery voltage
- Trim position
- Coolant pressure
- Coolant temperature
- Oil pressure
- Oil temperature
- Fuel flow
- Gear pressure
- Gear temperature
- Load %
- Boost pressure
- Steering angle

Note:

*Only available on supported engines.

On compatible engines the engine data page also provides options to initiate automatic engine oil level and transmission fluid level check procedures.

26.11 Faults

Fault code history

The fault codes tab displays live and historical detected engine faults.

Code	Description	Date & Time	Filter:
711 - 127	Oil level sensor - Security_Setup PORT engine	05/20/2022 10:11am	All
711 - 127	Oil level sensor - Critical - Oil Level PORT engine	05/20/2022 10:11am	Clear history
711 - 18	Oil level sensor - Critical - Oil Level PORT engine	05/20/2022 10:11am	
711 - 17	Oil level sensor - Transmission PORT engine	05/20/2022 10:08am	
711 - 17	Oil level sensor - Critical - Transmission PORT engine	05/20/2022 10:08am	

By default the Fault codes history tab displays fault codes for all engines. You can use the *[Filter]* option to display fault codes for a specific engine.

Active and historical engine fault codes can also be viewed from the display's Alarm manager: *[Homescreen > Alarms]* and selecting either *[Active]* or *[History]* tab.

On Board Diagnostics (OBD)

Displays that are configured for use with Mercury engines can display OBD faults. When an OBD fault occurs an alarm will be triggered on the display.

An OBD icon will be displayed on the splashscreen during boot up to signify that the display supports OBD.

Notifications and icons will be shown when an OBD fault occurs or is active.

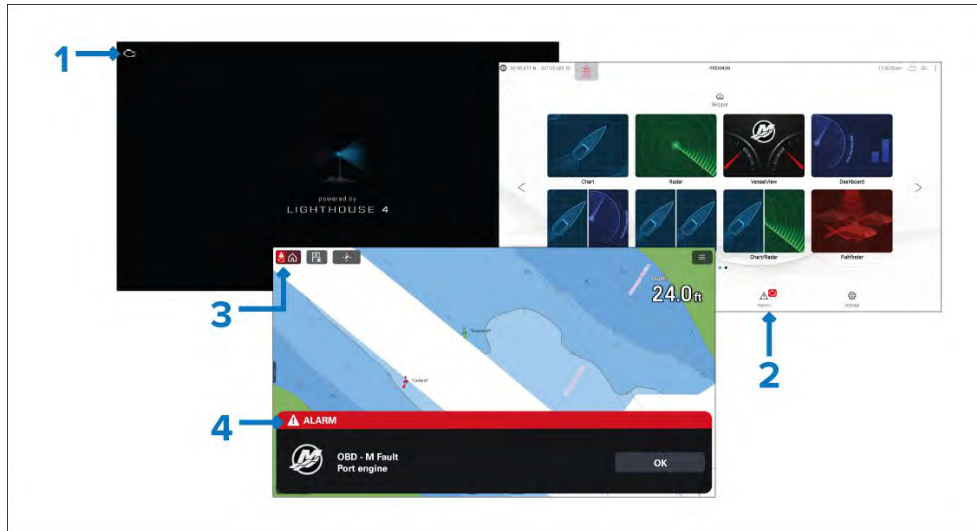

1. Splashscreen icon signifying that OBD is supported.
2. The Alarms icon on the homescreen will display an OBD icon when a fault is active.
3. The home icon in MFD apps will display an OBD icon when a fault is active.
4. When an OBD fault is triggered an alarm notification will be triggered.

OBD fault information will be available in the Alarm manager and in the Mercury app settings menu.

CHAPTER 27: YAMAHA APP

CHAPTER CONTENTS

- [27.1 Yamaha engine gateway selection — page 430](#)
- [27.2 Yamaha HDMI overview — page 430](#)
- [27.3 Yamaha app overview — page 430](#)
- [27.4 Customizing Data pages — page 431](#)
- [27.5 Engine page — page 435](#)
- [27.6 Settings — page 438](#)

27.1 Yamaha engine gateway selection

When the MFD is connected to Yamaha engines via a compatible gateway / interface, engine related data can be displayed in the dedicated Yamaha app.

Engine gateway selection is performed as part of the Boat details settings in the initial MFD start up wizard. The selection can also be changed in the Boat details settings tab: [*Homescreen > Settings > Boat details > Engine manufacturer*].

- If you have a compatible gateway interface, select [*Yamaha*] from the Engine manufacturer options.
- If you have a compatible gateway that includes the Yamaha MFD HDMI interface, select [*Yamaha HDMI*] from the Engine manufacturer options.

Compatible Yamaha gateways

The following gateways are compatible:

- The **Yamaha app** is compatible with Yamaha Command Link and Command Link Pro when connected to the MFD via a Yamaha NMEA 2000 gateway or CL7 gauge.
- The **Yamaha HDMI** app is compatible with Yamaha Command Link and Command Link Pro when connected to the MFD via a Yamaha Helm Master EX 6YG gateway and MFD interface (MFDI).

27.2 Yamaha HDMI overview

The MFD will display the HDMI video input feed from the Yamaha MFDI. Control is achieved using the Yamaha supplied handheld controller.

Please refer to the documentation that was supplied with your Yamaha engine system.

27.3 Yamaha app overview

The [*Yamaha app*] enables you to view engine system data from a connected Yamaha Command Link or Command Link Pro network.

Note:

- The Yamaha app will only display data when a compatible Yamaha Command Link or Command Link Pro network is connected to the MFD via a Yamaha NMEA 2000 gateway or CL7 gauge.
- The Yamaha app can only be displayed as a Fullscreen app page.
- The Yamaha app is pre-configured with a number of customizable data pages.
- For each instance of the Yamaha app you can select which Data pages you want to use; the Data page selection will persist over a power cycle.

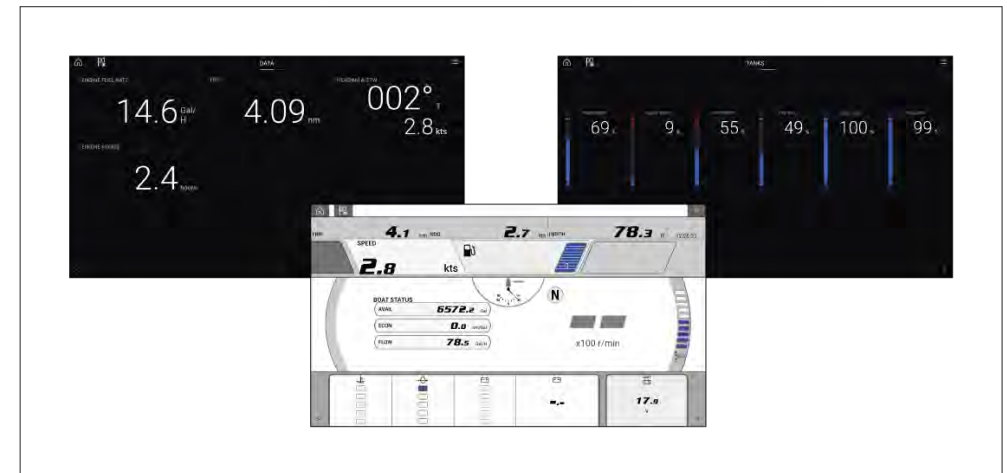







Requirements

The Yamaha app is available when a compatible Yamaha Command Link or Command Link Pro network is connected to the MFD via a Yamaha NMEA 2000 gateway (6YG-8A2D0-00-00) or CL7 display.

Note:

Do not use the Gateway module (6YG-8A2D0-00-00) and CL7 display together on the same network.

Yamaha app controls

Icon	Description	Function
	Home icon	Takes you to the Homescreen.
	Waypoint / MOB	Place waypoint / activate Man overboard (MOB) alarm.
	Pilot icon	Opens and closes the Pilot Sidebar
	Menu icon	Opens the app menu.
	Left arrow	Displays the previous data page.
	Right arrow	Displays the next data page.

Switching data page

1. Use the *[Left arrow]* and *[Right arrow]* buttons, located at the bottom of the screen, to cycle through the available data pages.
2. Alternatively, you can select a specific data page from the Yamaha app menu.

27.4 Customizing Data pages

The Yamaha App contains 3 default data pages: *[Engines]*, *[Data]* and *[Tanks]*. The data items displayed on each page can be changed, hidden or reset.

To customize each page:

1. Select and hold the relevant Data item.
 - i. Alternatively you can select *[Customize page]* from the app menu: *[Menu > Customize page]*.
2. Select *[Edit]*, *[Hide]* or *[Reset]* from the Data item pop-over menu.
 - i. *[Edit]*— you can select the new data item you want to add to the page.
 - ii. *[Hide]*— removes the data item from the page.
 - iii. *[Reset]*— reset the value of the selected data item (only available for certain data items).

Available data items

Engine page

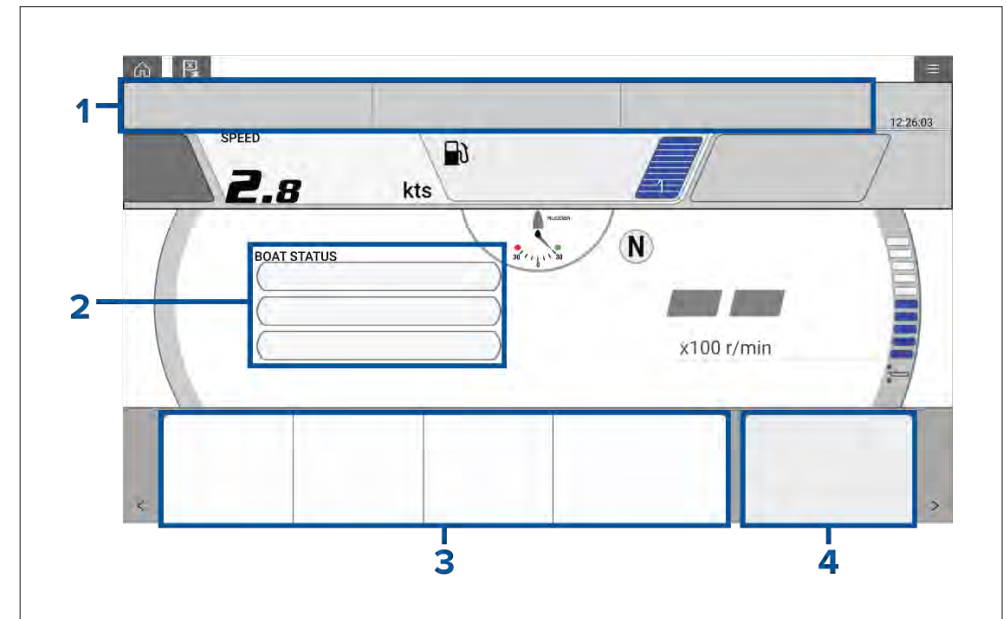

<i>[Cell 1 and Cell 2]</i>			
<i>[Data type]</i>	<i>[Data item]</i>	<i>[Data type]</i>	<i>[Data item]</i>

<i>[Depth]</i>	<ul style="list-style-type: none"> • Depth 	<i>[Environment]</i>	<ul style="list-style-type: none"> • Water Temp
<i>[Distance]</i>	<ul style="list-style-type: none"> • Trip 	<i>[GPS]</i>	<ul style="list-style-type: none"> • SOG
<i>[Engine]</i>	<ul style="list-style-type: none"> • Engine Trip Hours • Engine Hours 	<i>[Pilot]</i>	<ul style="list-style-type: none"> • Rudder
<i>[Fuel]</i>	<ul style="list-style-type: none"> • Engine economy total • Fuel flow total • Fuel used (trip) • Est. fuel remaining 	<i>[Speed]</i>	<ul style="list-style-type: none"> • STW
<i>[Cell 3]</i>		<i>[Cell 4]</i>	
<i>[Data type]</i>	<i>[Data item]</i>	<i>[Data type]</i>	<i>[Data item]</i>
<i>[Engine]</i>	<ul style="list-style-type: none"> • Coolant Temp • Coolant Pres • Alternator Level • Alternator • Oil Pres 	<i>[Boat]</i>	<ul style="list-style-type: none"> • Accessory voltage level • Accessory voltage • Supply voltage level • Supply voltage

Data Page



<i>[Data type]</i>	<i>[Data item]</i>	<i>[Data type]</i>	<i>[Data item]</i>
<i>[Battery]</i>	<ul style="list-style-type: none"> • TTZ • SOC 	<i>[GPS]</i>	<ul style="list-style-type: none"> • COG • Avg SOG • Max SOG • SOG • Loran Position • Position • COG SOG
<i>[Boat]</i>	<ul style="list-style-type: none"> • Mast Rot • Roll • ROT 	<i>[Heading]</i>	<ul style="list-style-type: none"> • Lock Hdg Err • Tack Heading • Lock Hdg • Heading • Heading & STW

<i>[Depth]</i>	<ul style="list-style-type: none"> • Max Depth • Min Depth • Depth 	<i>[Navigation]</i>	<ul style="list-style-type: none"> • VMG to Wpt • BTW & DTW • CMG & VMG to WPT • Compass • BTW • XTE • DTW • CMG • DMG • Wpt ETA • TTP • Target Pos • Loran Target Pos • Wpt TTG • Wpt • Rte ETA • Next turn angle • Origin target distance • Next waypoint name • BOTW
<i>[Distance]</i>	<ul style="list-style-type: none"> • Trip season • Trip month • Trip day • Trip manual • Ground Log • Trip • Log 	<i>[Pilot]</i>	<ul style="list-style-type: none"> • Rudder

<i>[Engine]</i>	<ul style="list-style-type: none"> • RPM • Engine Trip Hours • Fuel Rate (Avg) • Inst Fuel Economy • Engine Fuel Rate • Engine Hours 	<i>[Speed]</i>	<ul style="list-style-type: none"> • VMG to Wind • Avg STW • Max STW • STW
-----------------	--	----------------	--

<i>[Fuel]</i>	<ul style="list-style-type: none"> • Engine economy total • Fuel flow total • Time to empty • Distance to empty • Fuel used (season) • Total Trip Fuel • Fuel used (trip) • Est. fuel remaining 	<i>[Time]</i>	<ul style="list-style-type: none"> • Timer • Sunset Time • Sunrise Time • UTC Time • Local Time • UTC Date • Local Date • Time and Timer
<i>[Environment]</i>	<ul style="list-style-type: none"> • Drift from ps • Wind Chill (App) • Wind Chill (True) • Dew Point • Max Air Temp • Min Water Temp • Water Temp • Set • Drift • Sunrise/Sunset • Set Drift 	<i>[Wind]</i>	<ul style="list-style-type: none"> • Max AWA • GWD + Beaufort • TWA & TWS • TWA (CH) & TWS • TWA & VMG to Wind • AWA & AWS • AWA (CH) & AWS • AWA & VMG to Wind • GWS & GWD • AWS • Max AWS • Min AWS • AWA • AWA (CH) • Cardinal Wind • Min AWA • TWS

			<ul style="list-style-type: none"> • Min TWS • Max TWS • TWA • TWA (CH) • Max TWA • Min TWA • TWD • GWS • GWD • Beaufort (wind force scale)
--	--	--	---

Tanks Page

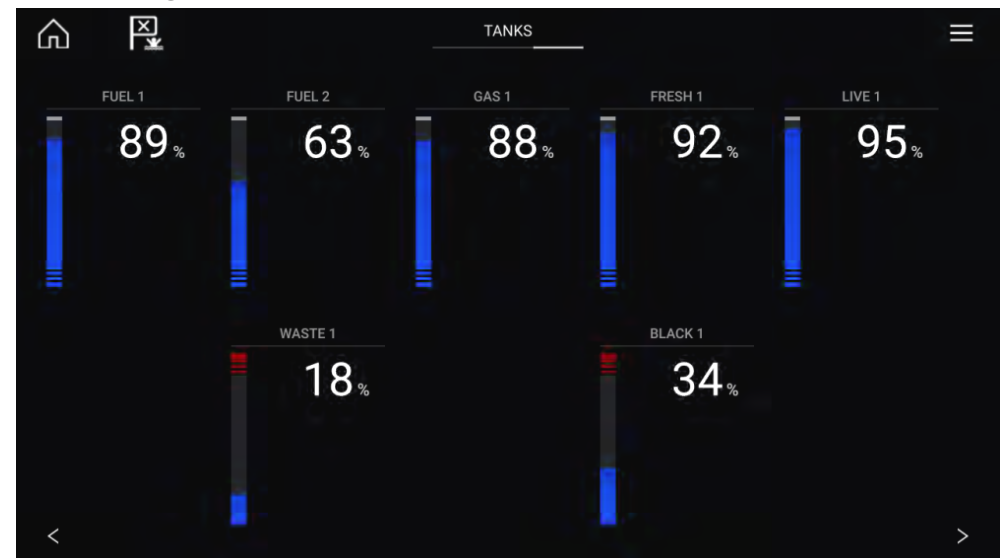

<i>[Data type]</i>	<i>[Data item]</i>	<i>[Data type]</i>	<i>[Data item]</i>
<i>[Boat]</i>	<ul style="list-style-type: none"> • Fresh Water • Live Well • Gray Water 	<i>[Fuel]</i>	<ul style="list-style-type: none"> • Total Fuel (vol) • Total Fuel

	• Black Water		• Fuel level
--	---------------	--	--------------

27.5 Engine page

In addition to the customizable data cells available, the Engine page also displays the following engine and tank data for your vessel:

- Rudder position (single engine only)
- Transmission
- Speed
- Revolutions Per Minute (r/min)
- Engine trim
- Number of fuel tanks and fill level

Troll mode can also be enabled from this page.

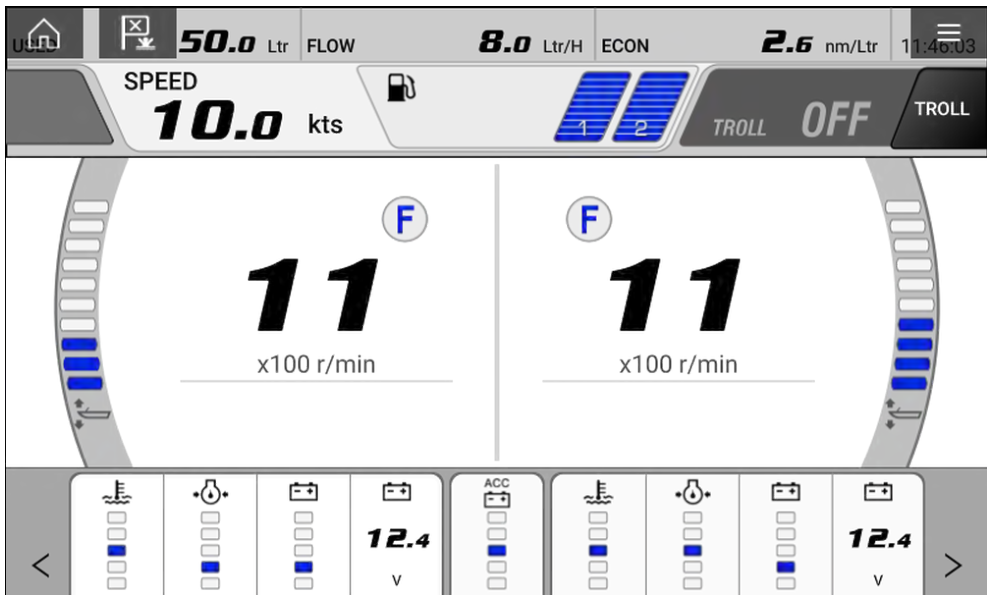

Engines

The number of Yamaha engines connected to your MFD's network determines how the engine page is displayed.

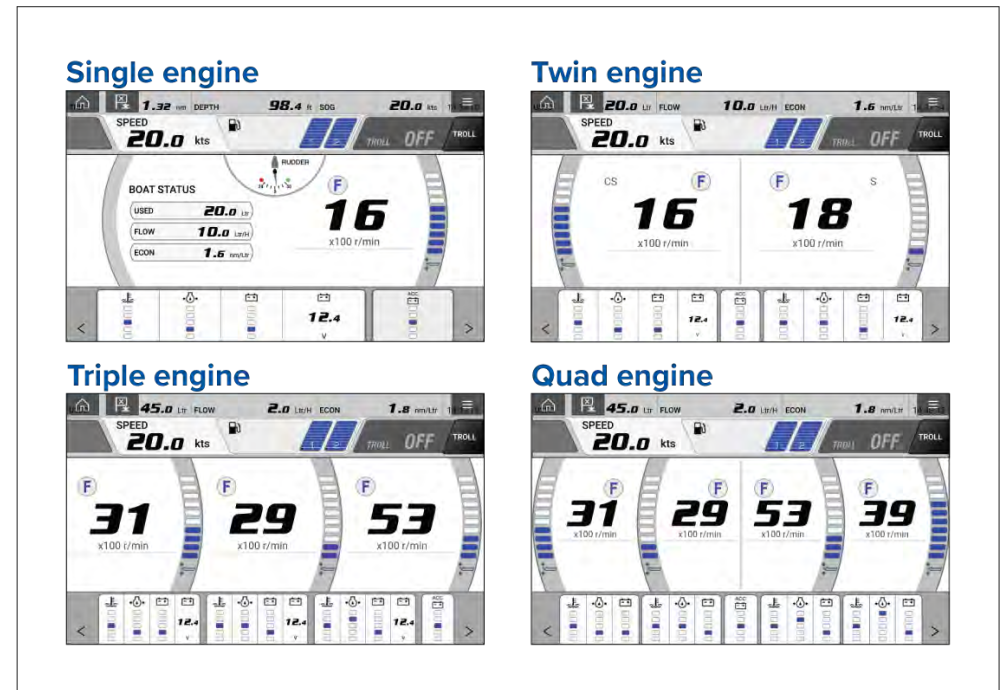

The number of engines and their manufacturer can be set on the *[Boat details]* page.

[Homescreen > Settings > Boat details]

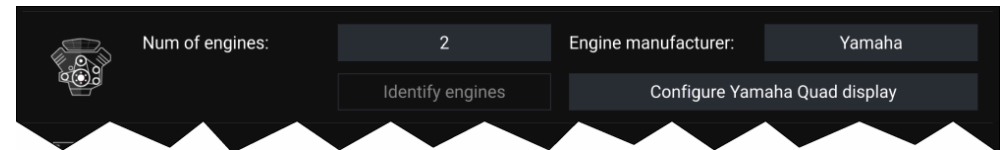

If your vessel is setup using the old quad engine system (2 MFDs for Port and Starboard Engines), you can select which engines are displayed per MFD by selecting *[Configure Yamaha Quad display]* and choosing *[Port side]* or *[Starboard side]*.

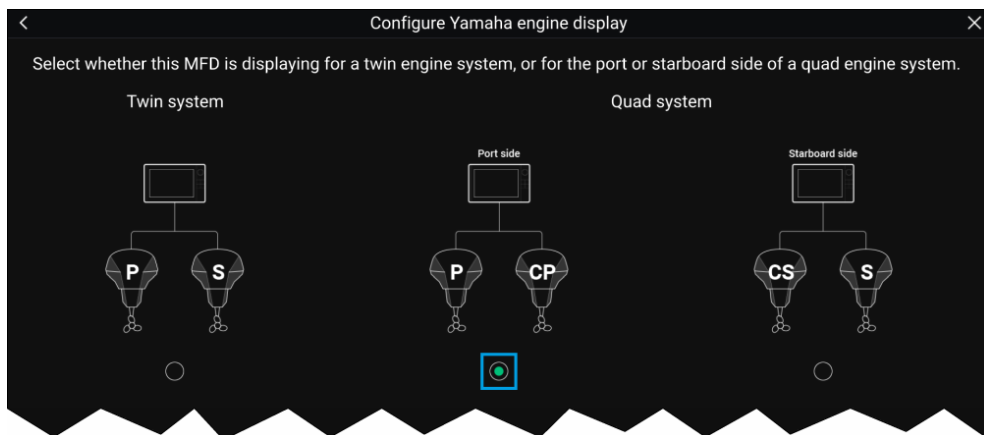

The engine page will update to reflect which engines your MFD is networked to, with Port and Central Port symbols or Starboard and Central Starboard symbols.

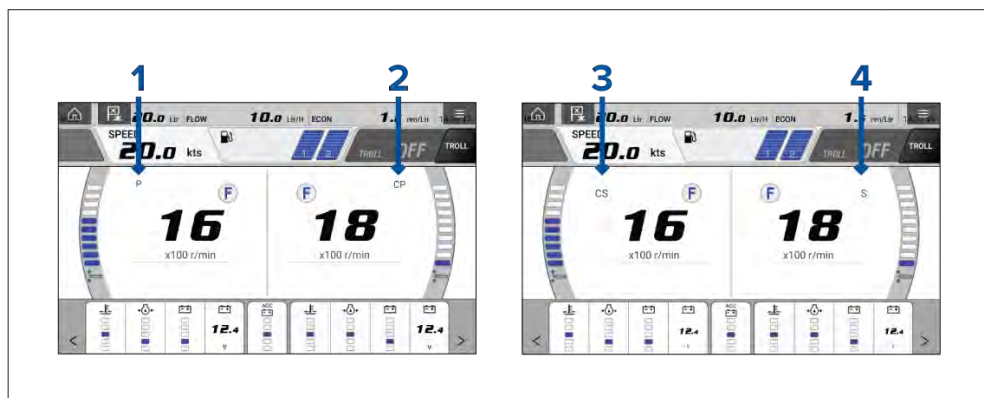

1. Port engine
2. Central Port engine
3. Central Starboard engine
4. Starboard engine

Transmission

The transmission icons indicate which transmission mode your vessel's engine is currently in:

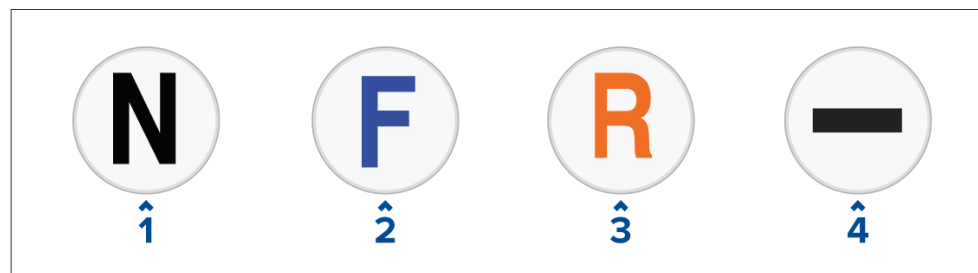

1. Neutral
2. Forward
3. Reverse
4. No transmission data detected

Note:

If no transmission information is detected from the CAN bus after 3 seconds, it will timeout. Ensure that your engine(s) are compatible and have been connected to your MFD network correctly.

Status and warning indicators

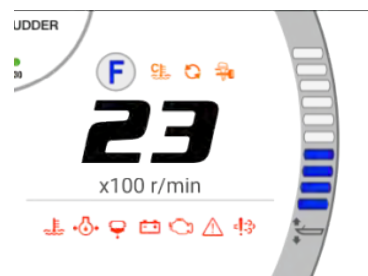

The engine page will display indicators for engine status and warnings.

These status and warning symbols are described below:



1. [Engine warming up status]

2. [Synchronization status]
3. [Immobilizer lock status]

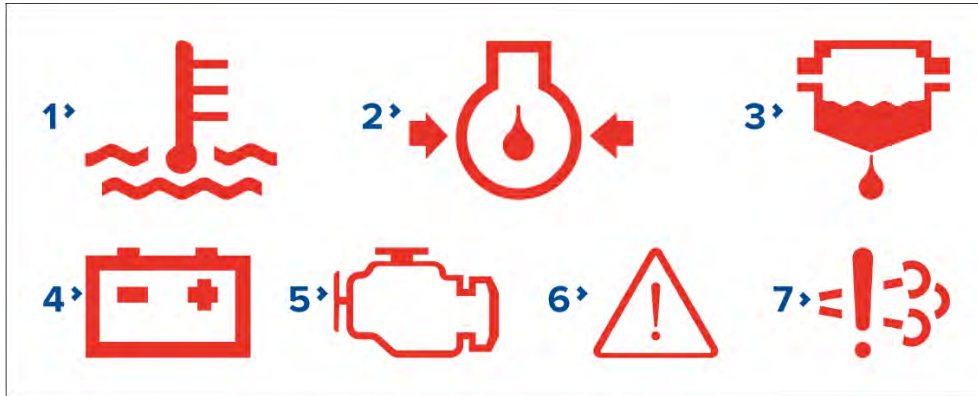

1. [Overheat warning]
2. [Low oil pressure warning]
3. [Water in fuel warning]
4. [Low voltage warning]
5. [Check engine warning]
6. [Steering system warning]
7. [Catalyst warning]

Tanks



The engine page displays the number of tanks aboard your vessel, their type, instance number and fill level.

Note:

- The number of tanks and their type is determined during the installation wizard.
- Tanks require calibration, for more information refer to [7.7 Calibrating tanks](#)
- No more than 6 tanks can be displayed on the engine page.
- If there are more than 6 tanks detected on your vessel's network the engine page will display them using the following hierarchy: fuel, fresh water, waste water, gasoline, followed by prioritizing the lowest instance numbers first.

Engine trim



The trim bar displays the trim level of your engine(s), a higher blue bar equates to a higher trim percent. The trim bar will begin to flash if you attempt to set the engine trim beyond 100%.

Troll mode



If your engine supports Troll mode it can be enabled from the engine page. Troll mode is enabled by pressing the Troll mode toggle or by selecting it from the menu.

Note:

- Lower engine RPM and go into idle mode before attempting to activate Troll mode.
- When Troll mode is enabled your RPM gauge will change from x100 r/min to r/min, allowing for more precise control.

27.6 Settings

The settings page can be used to view fault codes, schedule maintenance, and calibrate your engine(s).

Fault codes

The fault codes tab displays all live engine faults detected on the network.

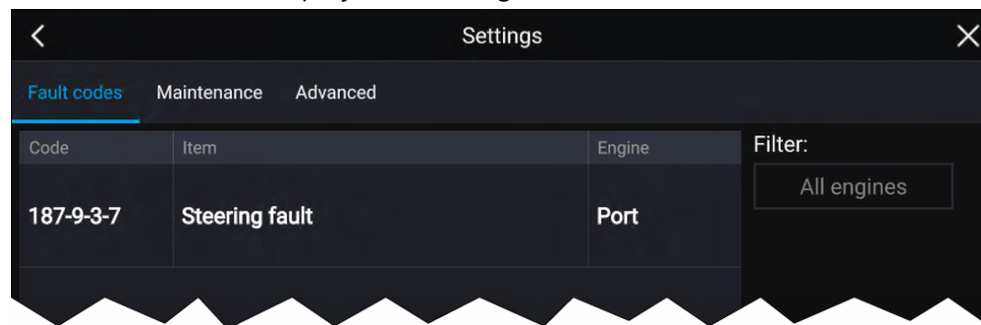

Note:

- The fault codes tab default setting is to display fault codes from all engines.
- You can use the filter option to display fault codes for a specific engine and hide codes for all other engines.

Maintenance

The Maintenance tab displays the amount of time since your Yamaha engine(s) have been serviced.

The amount of hours since last service will automatically accumulate when your Yamaha engine(s) are running. When your engine(s) have been serviced you can long hold the row and select *[Reset]* from the pop up to return the amount of hours back to 0.

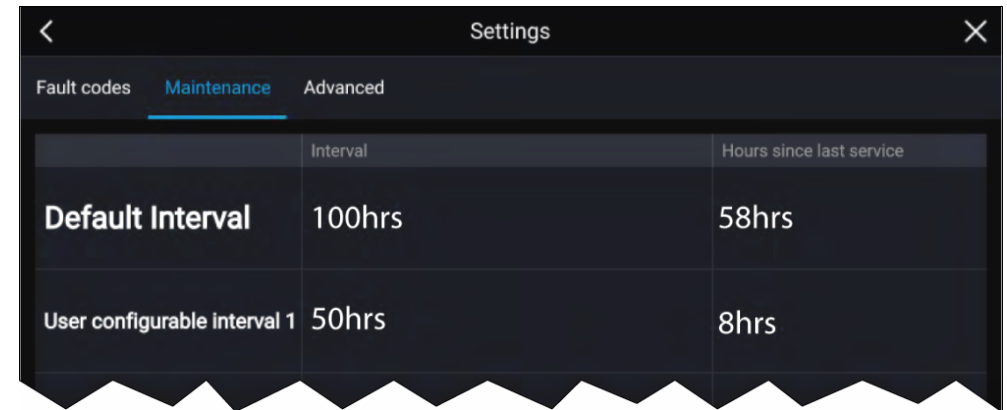

Note:

- A default interval of 100 hours is displayed at the top, this is the recommended maximum amount of time you can use your engine(s) before a service is required.
- Additional user configurable intervals can be customized by long holding each row and choosing the interval length.

Advanced

The Advanced tab is used during the installation and calibration of your Yamaha engine(s). For more information on how to install and calibrate your Yamaha engine(s) refer to Yamaha engine installation manual or Yamaha dealer.

[Options:]

[Gateway reset]— System protocol information reset.

[Engine instances reset]— Engine instances reset. Engine(s) will be reordered based on engine position:

Engine	Port	Central or Central Port	Central Star- board	Star- board
Single Engine	0	-	-	-
Twin Engine	0	-	-	1
Triple Engine	0	1	-	2
Quad Engine	0	1	2	3

[All pages reset]— All data items on each data page are reset to default.

[Fuel flow offset]— Set the Fuel flow offset value in accordance with your Fuel flow gauge reading.

[Trim Calibration]— Calibrate your engine trim by pressing *[Set to zero]* if any number other than 0 is showing on the Trim Position when engine(s) have stopped.

CHAPTER 28: VIDEO APP

CHAPTER CONTENTS

- [28.1 Video app overview — page 441](#)
- [28.2 Thermal camera screen overview — page 444](#)
- [28.3 Opening the Video app — page 444](#)
- [28.4 Video app settings — page 447](#)
- [28.5 Maritime \(M-Series\) camera compatibility — page 450](#)

28.1 Video app overview

Analog video feeds and IP (Internet Protocol) digital video feeds can be viewed, recorded and played back on the display using the Video app. Examples of video feeds include: CCTV cameras and Thermal imaging cameras, Blu-Ray player etc. It may also be possible to view analog video feeds from other sources using a suitable third party analog-to-IP video converter.

Up to 4 video feeds can be displayed simultaneously when using a splitscreen app page.

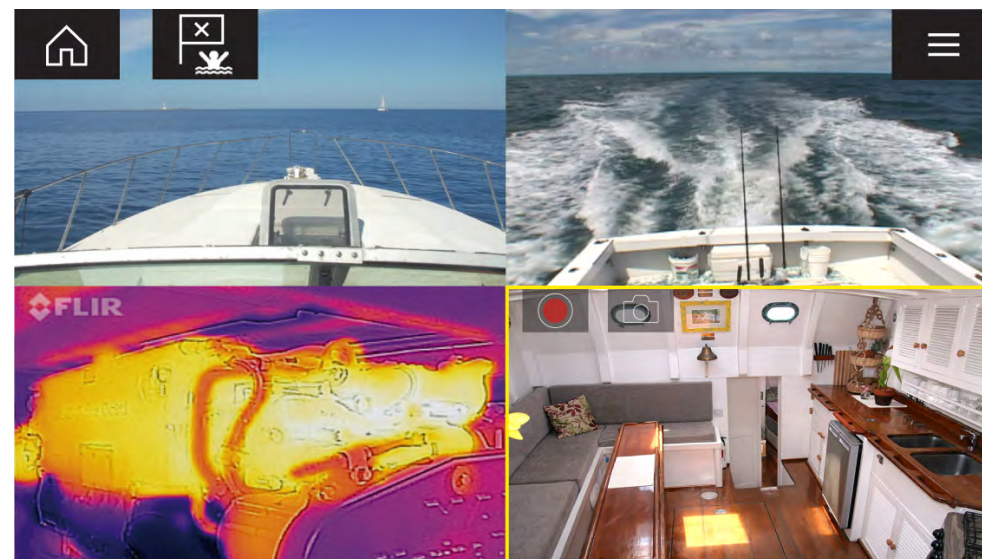

Warning: Distraction disclaimer

- The MFD/Chartplotter includes various entertainment apps. Whilst navigating do NOT let these apps distract your attention from safe navigation.
- Any distraction while navigating causes a lapse in concentration which increases the risk of collision. To avoid hazards you must give navigation your full attention at all times.

Video app pages

Each Video app instance is unique, this means that once you have selected a feed to display in a Video app page then your feed selection is saved and the same feed will be displayed whenever that app page icon is opened from the Homescreen. If you open the same Video app page from a networked MFD, the same feed will be displayed on each MFD.

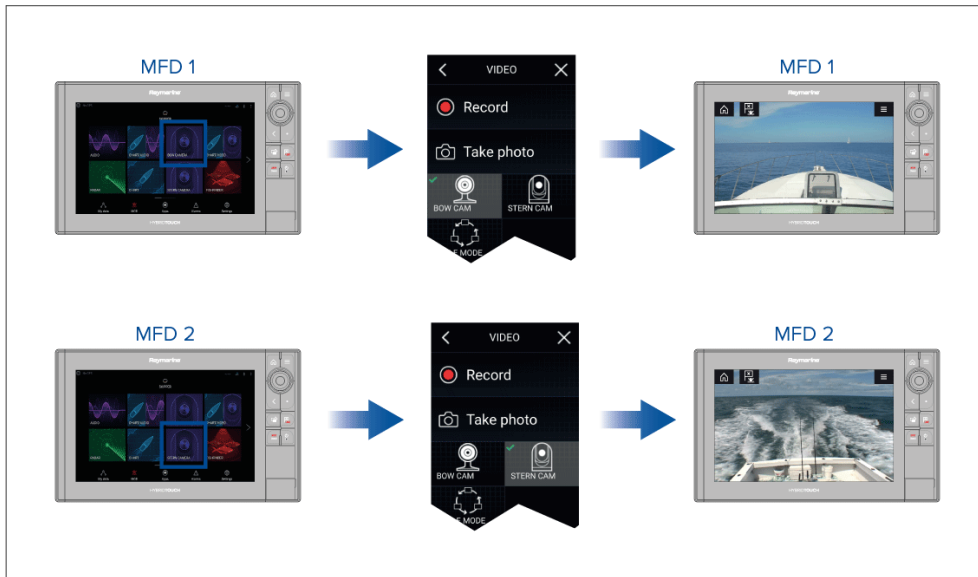

You can create additional Video app pages and assign a different feed to each. This will allow you to view multiple feeds on multiple networked MFDs simultaneously.

For example, if you want to display a different video feed on different networked MFDs, you must first create additional Video app pages.

Note:

When you have multiple Video app page icons on your Homescreen, you may wish to rename each icon to help you easily identify the feeds(s) assigned to each app page. For information on how to rename Homescreen icons, refer to:

[p.95 – Customizing an existing app page](#)

Renaming video feeds

In multi camera installations you can rename your feed from within the Video app.

From the Video app menu:

1. Select the icon for the camera you want to rename so that its feed is displayed.
2. Goto the Video app's *[Settings]* menu: *[Menu > Settings]*.

3. Select the *[Camera setup]* tab.
4. Select the Camera name field.
5. Use the onscreen keyboard to rename your feed and then select *[Save]*.

Repeat the above steps for each video feed you want to rename. You can also associate a different icon to your video feed by selecting the *[Icon]* field.

Video app controls

Icon	Description
	<i>[Home icon]</i> Takes you to the Homescreen
	<i>[Waypoint / MOB]</i> Place waypoint / activate Man overboard (MOB) alarm
	<i>[Pilot icon]</i> Opens and closes the Pilot Sidebar
	<i>[Menu icon]</i> Opens the app menu
	<i>[Record]</i> Start recording (Replaced by Stop icon whilst recording.)
	<i>[Stop]</i> Stop recording (Replaced Record icon when not recording.)
	<i>[Take photo]</i> Take a photo of what is currently displayed in the active feed.

Pan, Tilt, Zoom (PTZ) camera controls

Extra controls are available for cameras that can pan, tilt or zoom.

- Using the touchscreen, swipe your finger across the screen to pan or tilt the camera.
- Using the touchscreen, use a “Pinch-to-Zoom” action with your thumb and forefinger to zoom in and out of the video image.

- When not in use, place the camera in the Parked position by selecting *[Park camera]* from the menu: *[Menu > Park camera]*
- To move the camera to its Home position, select *[Home]* from the menu: *[Menu > Home]*

Image flip and mirroring

Depending on the specific type of camera connected, the video feed can be flipped upside down and reversed.

Flipping the camera image is required when the camera has been installed upside-down (ball-down configuration). In this scenario, flipping the image will correct the image's orientation onscreen.

Reversing the image is useful for installations where the camera is rear-facing and you are viewing the image on a forward-facing display, as it provides an effect similar to looking through a rear view mirror.

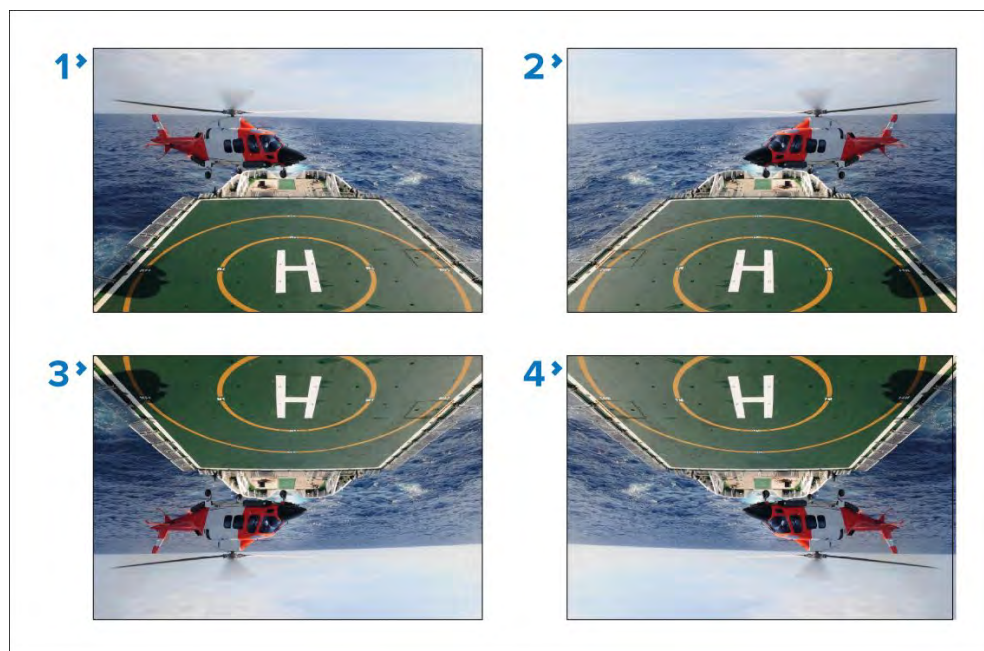

1. **Standard view** — For forward-facing cameras.
2. **Mirrored/reverse view** — For cameras facing aft.
3. **Image flipped view** — For forward-facing cameras, where the camera image appears upside down.

Video app

4. **Image flipped and mirrored / reverse view** — For cameras facing aft, where the camera image appears upside-down.

On supported cameras, the video feed can be flipped and reversed directly from the Video app's *[Camera setup]* menu. *[Menu > Settings > Camera setup]*.

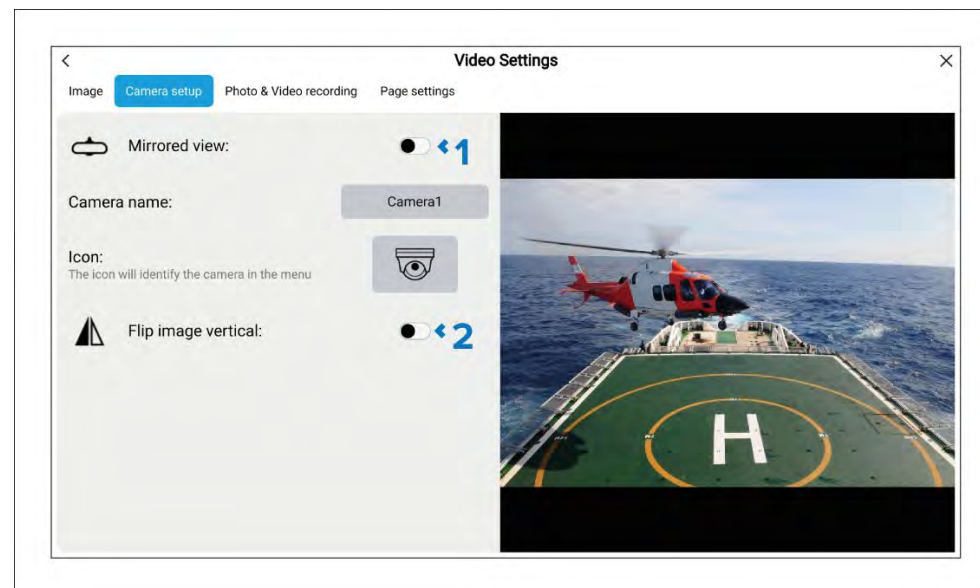

1. *[Mirrored view]* — When enabled, mirrors / reverses the image.
2. *[Flip image vertical]* — When enabled, image is flipped upside-down.

If the camera supports image flip and reversing but the controls are not available in the Camera setup menu, you may be able to access the camera's built-in web interface to change these settings. Refer to the documentation for your camera for details.

Note:

Augmented reality — If your camera supports Augmented Reality (AR), flipping the image and / or reversing the image will prevent Augmented Reality (AR) objects appearing correctly onscreen.

28.2 Thermal camera screen overview

When viewing the thermal or visible light video feed of a compatible thermal camera, additional controls are available.

Note:

The status icons are embedded in the video stream from the camera. Only the focus and zoom controls can be interacted with.

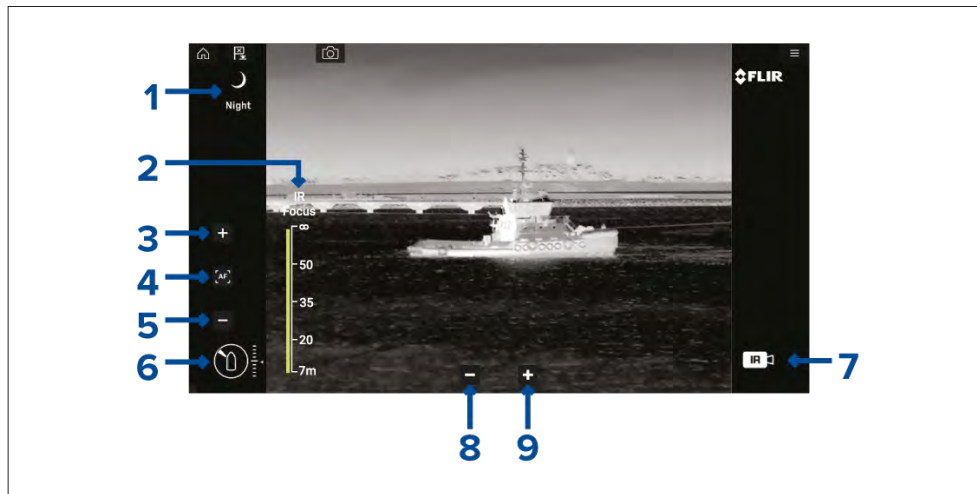

1. **Scene** Automatic Gain Control (AGC) settings — the icon for the currently selected scene is displayed. The following scenes are available:

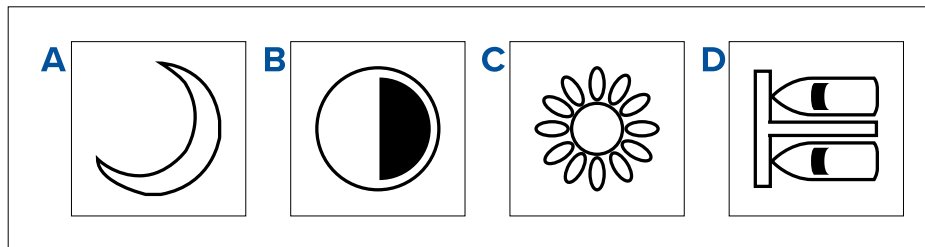

- a. *[Night scene]*— optimized for use on the open water at night.
- b. *[Contrast scene]*— optimized for good visibility of small moving objects.
- c. *[Day scene]*— optimized for use on the open water during the day.

- d. *[Docking scene]*— optimized for use when the boat is docking at night.
2. *[IR Focus]*— shown when autofocus is activated, to indicate the progress of the operation.
 3. ⁽¹⁾*[Increase focus]*— manually increases camera focus.
 4. ⁽¹⁾*[Autofocus]*— enable/disable autofocus.
 5. ⁽¹⁾*[Decrease focus]*— manually decrease focus.

Note: (1) For cameras that support manual focus, the controls are displayed temporarily when you tap the touchscreen.

6. **Azimuth (Position) and Elevation (Tilt) indicator** — Shows the azimuth (or direction) of the camera relative to the vessel, as well as the vertical tilt of the camera. The triangle shows the approximate camera field of view (FOV). The diamond shows the approximate camera position.
7. **Payload** — Identifies the type of video feed being displayed, e.g. thermal or visible light.

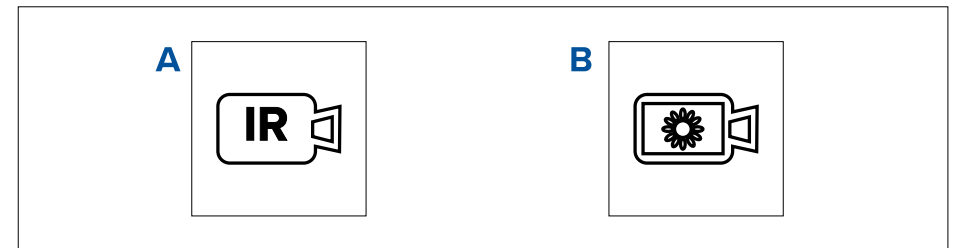

- a. *[Thermal video feed]*
 - b. *[Daylight / visible light video feed]*
8. *[Zoom out]*
 9. *[Zoom in]*

28.3 Opening the Video app

The Video app is opened by selecting an app page icon from the Homescreen which includes the Video app.

Pre-requisites:

1. Ensure your video feed is compatible by checking the latest details available on the Raymarine website against your device's specification. If in doubt please contact an authorized Raymarine dealer for advice.
2. Ensure you have installed your video device in accordance with the documentation that was supplied with your device.

The Video app will open in 1 of 3 states:

Note:

If the Video app is opened soon after powering on your system, you may have to wait for the device(s) to finish booting before the video feed is displayed.

Video feed displayed

If your device is powered up and operational then the Device's video feed is displayed.



Camera not yet available

The '**Camera not yet available**' message is displayed if:

- a Video app page is opened before the camera has finished booting up.
- connection to the camera is lost.

[Video app](#)

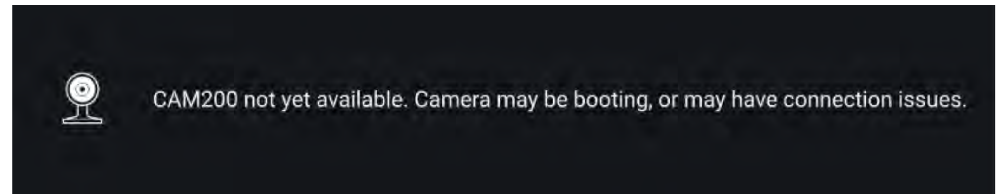

If the '**Camera not yet available**' message is displayed for more than 2 minutes, then your MFD cannot connect to your camera. Ensure network and power connections to your camera and MFD are correct and free from damage and then power cycle your system. If the camera feed is still not displayed, refer to your equipment's installation documentation for further troubleshooting information.

No camera detected

The '**No camera detected**' message is displayed if:

- a Video app page is opened for the first time and no compatible camera is connected.
- a Video app page is opened for the first time before the camera has finished booting up.

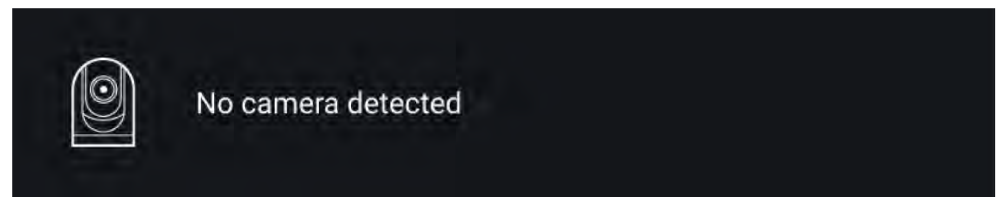

If the '**No camera detected**' message is displayed for more than 2 minutes, then your MFD cannot connect to your camera. Ensure network and power connections to your camera and MFD are correct and free from damage and then power cycle your system. If the camera feed is still not displayed, refer to your equipment's installation documentation for further troubleshooting information.

Selecting a video feed

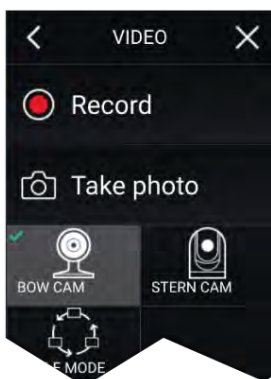

You can change the feed that is displayed in the Video app. From the Video app main menu, select the icon for the camera that you want to display.

Dual streaming

M-Series cameras with dual payloads (visible and thermal camera lens) can stream a visible feed and thermal feed simultaneously.

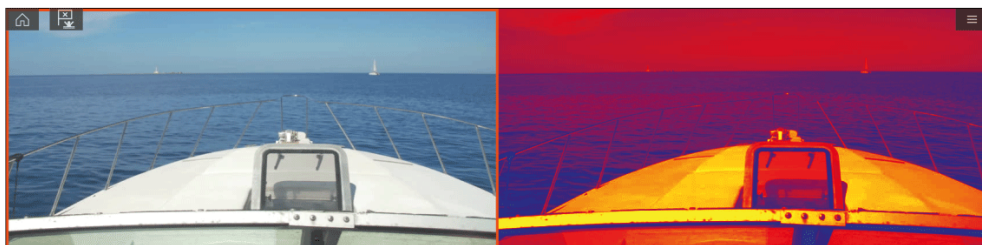

Note:

Dual streaming requires:

- A dual payload M-Series camera: M300, M400 and M500.

Single MFD

Activate dual video streaming on a single MFD.

1. From the *[Homescreen]*, create a custom combo app that comprises of at least 2 *[Video apps]*. For more information on creating and customizing LightHouse apps, refer to: [p.95 – Creating an app page](#)
2. Open the combo app and select one of the Video app instances.
3. Select the dual payload camera and select the stream you want to display (visible or thermal):

[Combo app > Menu > Settings > Image Tab > Active feed > Visible / Thermal]

4. Repeat steps 2 and 3 for the other app instance and video stream.

Dual MFDs

Activate dual video streaming on at least 2 MFDs connected on the same network.

Note:

Make sure your MFDs are both correctly connected on the same network as the dual payload camera.

1. Open the *[Video app]* on one of the MFDs.
2. Select the dual payload camera and select the stream you want to display (visible or thermal):

[Video app > Menu > Settings > Image Tab > Active feed > Visible / Thermal]

3. Repeat steps 1 and 2 for the other MFD and video stream.

28.4 Video app settings

The Settings menu provides access to the Video app's features and functions. The options available in the Settings menu are dependent on your system configuration and connected devices.

Image tab

Settings	Options
<p><i>[Active feed]</i></p> <p>On cameras with more than 1 payload you can select which feed to display in the Video app.</p>	<ul style="list-style-type: none"> • Thermal • Visible
<p><i>[Blending Mode]</i></p> <p>On cameras with more than 1 payload you can blend the two feeds together, displaying an overlap of daylight stream on top of thermal image, providing enhanced detail.</p> <ul style="list-style-type: none"> • CTV - Colored daylight image blended with the thermal feed. • MSX - Black and white daylight image detects and sharpens the edges of objects shown on the thermal feed. 	<ul style="list-style-type: none"> • Off • CTV • MSX
<p><i>[Blending Level]</i></p> <p>Set the percentage of the blend between both camera feeds for CTV or MSX blending.</p>	<ul style="list-style-type: none"> • 0% to 100%
<p><i>[Light]</i></p> <p>For cameras that include a light this setting switches the camera's light on and off as well as flashing mode and SOS mode.</p>	<ul style="list-style-type: none"> • On • Off • Flash • SOS

Settings	Options
<p><i>[Palette]</i></p> <p>Various color palettes are available to suit different conditions or your personal preference.</p>	<ul style="list-style-type: none"> • WhiteHot • BlackHot • RedHot • RedHot Inverse • Fusion • Firelce • Firelce Inverse
<p><i>[Scene]</i></p> <p>Scene presets that have been optimized for different running conditions.</p>	<ul style="list-style-type: none"> • Day • Night • Docking • High contrast
<p><i>[Auto focus]</i></p> <p>The camera will focus the image.</p>	<ul style="list-style-type: none"> • Activate
<p><i>[Low light mode]</i></p> <p>Visible cameras supporting low light mode can set this during low light conditions.</p>	<ul style="list-style-type: none"> • On • Off • Auto
<p><i>[Wide Dynamic Range]</i></p> <p>Improves the viewable range of darkness to lightness of the image.</p>	<ul style="list-style-type: none"> • Disable • Enable
<p><i>[Contrast Enhancement]</i></p> <p>Adjusts the brightness and contrast of the image to make dark and bright sections more distinguishable.</p>	<ul style="list-style-type: none"> • Disable • Enable
<p><i>[Electronic stabilization]</i></p> <p>Stabilizes the image to reduce blurring caused by camera shake.</p>	<ul style="list-style-type: none"> • Disable • Enable

Settings	Options
<i>[Digital Zoom]</i> Zooms the camera feed to maximum.	<ul style="list-style-type: none"> • Disable • Enable
<i>[Roll correction]</i> <i>(Requires AR200)</i> Accounts for boat tilting and will adjust video feed accordingly. Video feed horizon will be parallel with the actual horizon.	<ul style="list-style-type: none"> • Disable • Enable

Camera setup tab

Settings	Options
<i>[Heater]</i> Enables and disables the camera's built-in heater used to de-mist the camera lens.	<ul style="list-style-type: none"> • Disable • Enable
<i>[Zoom Lock]</i> Synchronize zoom level between visible and thermal camera feeds.	<ul style="list-style-type: none"> • Disable • Enable
<i>[Mirrored view]</i> Flips the camera image to provide a mirror image, suitable for rear view installations.	<ul style="list-style-type: none"> • Disable • Enable
<i>[Camera name]</i> Change your camera name.	<ul style="list-style-type: none"> • Displays the onscreen keyboard.
<i>[Icon]</i> Select the icon to be used for the camera.	<ul style="list-style-type: none"> • List of icons.
<i>[Flip image vertical]</i> Flips the camera image upside down, suitable for Ball-down installations.	<ul style="list-style-type: none"> • Disable • Enable
<i>[UI language]</i> Select the language of the user interface.	<ul style="list-style-type: none"> • List of languages.

Settings	Options
<i>[On-screen icons]</i> Sets the level for the camera's built-in onscreen icons	<ul style="list-style-type: none"> • None • Minimal • All
<i>[Save default settings]</i> Save the current camera settings as the default.	<ul style="list-style-type: none"> • Save
<i>[Restore default settings]</i> Restore the camera settings to default.	<ul style="list-style-type: none"> • Run default restore
<i>[Self-tests and calibration]</i> Offers a series of tests and calibration options for your camera.	<ul style="list-style-type: none"> • Pan/tilt test • Reset IR lens • Flat Field Correction • Set elevation reference • Set forward position
<i>[Restore factory settings]</i> Restore camera settings to factory default.	<ul style="list-style-type: none"> • Run factory restore

Photo and Video recording tab

Settings	Options
<i>[Save files to:]</i> Determines the save location for photos and video recordings.	<ul style="list-style-type: none"> • SD 1 • External SD 1 • USB Media

Note:

[External SD 1] and *[USB Media]* are available when using the RCR-SDUSB (A80440) Accessory.

ClearCruise™ tab (Augmented Reality) (Requires AR200)

Settings	Options
<i>[Augmented Reality]</i> Enables / disables Augmented Reality and Augmented reality settings.	<ul style="list-style-type: none"> • Disable • Enable
<i>[AIS labels]</i> Display other vessels as flags (requires AIS).	<ul style="list-style-type: none"> • Disable • Enable
<i>[Hide static targets]</i> Hide AIS targets travelling under 2 knots (requires AIS).	<ul style="list-style-type: none"> • Disable • Enable
<i>[Waypoints]</i> Display Waypoints as flags.	<ul style="list-style-type: none"> • Disable • Enable
<i>[Chart objects]</i> Display Chart objects as flags (requires compatible charts).	<ul style="list-style-type: none"> • Disable • Enable
<i>[Cartography source]</i> Select the cartography ClearCruise displays data from (requires compatible charts).	<ul style="list-style-type: none"> • Cartography source options
<i>[Compass]</i> Display the Compass bar.	<ul style="list-style-type: none"> • Disable • Enable
<i>[Range limit]</i> Set the maximum range flags will automatically be displayed from.	<ul style="list-style-type: none"> • 1/8nm to 13nm

ClearCruise™ tab (Object Detection) / (Video Analytics)

Settings (ClearCruise™ tab — Object Detection / Video Analytics)	Options
<i>[Highlight detected objects]</i> Uses proprietary ClearCruise™ technology to highlight and track objects detected in the water.	<ul style="list-style-type: none"> • Disable • Enable
<i>[Beep on detection]</i> When enabled, the MFD will audibly beep when an object is detected.	<ul style="list-style-type: none"> • Disable • Enable
<i>[Display estimated range]</i> When enabled, the MFD will display an estimated range for highlighted objects (objects must be closer than 300 ft).	<ul style="list-style-type: none"> • Disable • Enable
<i>[Detection threshold]</i> Enables you to change the object detection sensitivity.	<ul style="list-style-type: none"> • 1 to 16

Camera motion tab

Settings	Options
<i>[Camera height above the waterline]</i> To ensure correct alignment of the camera for tracking purposes the height the camera has been installed at, above the waterline, must be set.	<ul style="list-style-type: none"> • 0ft to 99ft
<i>[Set forward position]</i> Adjust the Forward position of your camera	Displays the forward alignment picture
<i>[Man overboard]</i> Enables and disables automatic tracking of a MOB alarm. The most recent target is tracked.	<ul style="list-style-type: none"> • Disable • Enable

Settings	Options
<p><i>[Dangerous AIS targets]</i></p> <p>Enables and disables automatic tracking of Dangerous AIS targets.</p> <p>The most recent target is tracked.</p>	<ul style="list-style-type: none"> • Disable • Enable
<p><i>[Dangerous MARPA targets]</i></p> <p>Enables and disables automatic tracking of Dangerous Radar targets.</p> <p>The most recent target is tracked.</p>	<ul style="list-style-type: none"> • Disable • Enable
<p><i>[Vertical stabilization]</i></p> <p>Minimizes the effects of vessel pitch (while used in a forward or reverse facing position) and vessel roll (while used in a port or starboard facing position).</p>	<ul style="list-style-type: none"> • Disable • Enable
<p><i>[Horizontal stabilization]</i></p> <p>Minimizes the effects of vessel pitch (while used in a forward or reverse facing position) and vessel roll (while used in a port or starboard facing position).</p> <p>*Horizontal stabilization is intended to keep the camera pointed in a fixed heading, even as the vessel turns.</p>	<ul style="list-style-type: none"> • Disable • Enable

Note:

Horizontal stabilization is not a form of target tracking. It is best used to reduce the effects of subtle heading changes when running in a fixed direction. Whenever the vessel makes a notable course change, the camera will need to be manually adjusted to align with the new heading

<p><i>[Enable scan]</i></p> <p>Enables and disables Surveillance mode.</p> <p>Surveillance mode pans the camera left to right continuously to the specified speed</p>	<ul style="list-style-type: none"> • Disable • Enable
---	---

Settings	Options
<p><i>[Scan width]</i></p> <p>Determines how far the camera pans from left to right when in Surveillance mode.</p>	<ul style="list-style-type: none"> • Narrow • Medium • Wide
<p><i>[Scan speed]</i></p> <p>Determines the speed at which the camera pans from left to right when in Surveillance mode.</p>	<ul style="list-style-type: none"> • Slow • Medium • Fast

Page settings

Settings	Options
<p><i>[Edit data overlays]</i></p> <p>Add data overlays to video feed.</p>	<ul style="list-style-type: none"> • List of data overlays
<p><i>[Fullscreen mode]</i></p> <p>Hides the <i>[Home]</i> and <i>[Menu]</i> buttons when viewing the live video feed.</p> <p>To show the <i>[Home]</i> or <i>[Menu]</i> buttons, swipe down from the top of the screen or use the power swipe / key.</p>	<ul style="list-style-type: none"> • Disable • Enable

28.5 Maritime (M-Series) camera compatibility

Support for the various video features and settings, as per each M-Series camera variant.

For an explanation of the settings listed in the following table, refer to: [p.447 – Video app settings](#)

Note:

- **(1)** Only applicable to the M364 C / M364 C LR dual payload visible and thermal cameras.
- **(2)** Only applicable to the M332 / M364 single payload thermal cameras.
- **(3)** Only applicable to the M300 C single payload visible camera.
- **(4)** Only applicable to the M364 C / M364 C LR dual payload visible and thermal cameras, and, the M364 single payload thermal camera.

Setting (Image)	Compatible cameras
<i>[Active feed]</i>	<ul style="list-style-type: none"> • (1) M300
<ul style="list-style-type: none"> • Thermal • Visible 	<ul style="list-style-type: none"> • M400 • M500
<i>[Blending mode]</i>	<ul style="list-style-type: none"> • (1) M300
<ul style="list-style-type: none"> • Off • CTV • MSX 	
<i>[Blending level]</i>	<ul style="list-style-type: none"> • (1) M300
<ul style="list-style-type: none"> • 0% to 100% 	
<i>[Light]</i>	<ul style="list-style-type: none"> • M400 • M500
<ul style="list-style-type: none"> • Off • On • Flash • SOS 	
<i>[Palette] (Thermal feed)</i>	<ul style="list-style-type: none"> • M100 / M200 • (1 & 2) M300 • M400 • M500
<ul style="list-style-type: none"> • WhiteHot • BlackHot • RedHot • RedHot Inverse • Fusion • Fusion Inverse • Firelce • Firelce Inverse 	

Setting (Image)	Compatible cameras
<i>[Scene] (Thermal feed)</i>	<ul style="list-style-type: none"> • M100 / M200 • (1 & 2) M300 • M400 • M500
<ul style="list-style-type: none"> • Day • Night • Docking • High Contrast 	
<i>[Auto focus] (Visible feed)</i>	<ul style="list-style-type: none"> • N / A
<ul style="list-style-type: none"> • Activate 	
<i>[Low light mode] (Visible feed)</i>	<ul style="list-style-type: none"> • (1 & 3) M300 • M400 • M500
<ul style="list-style-type: none"> • Off • On • Auto 	
<i>[Wide dynamic range] (Visible feed)</i>	<ul style="list-style-type: none"> • (1 & 3) M300 • M400 • M500
<ul style="list-style-type: none"> • Disable • Enable 	
<i>[Contrast enhancement] (Visible feed)</i>	<ul style="list-style-type: none"> • N / A
<ul style="list-style-type: none"> • Disable • Enable 	
<i>[Electronic stabilization] (Visible feed)</i>	<ul style="list-style-type: none"> • M400 • M500
<ul style="list-style-type: none"> • Disable • Enable 	
<i>[Digital Zoom]</i>	<ul style="list-style-type: none"> • M100 / M200 • (1 & 3) M300 • M400 • M500
<ul style="list-style-type: none"> • Disable • Enable 	
<i>[Roll correction] (Requires AR200)</i>	<ul style="list-style-type: none"> • M100 / M200 • M300
<ul style="list-style-type: none"> • Disable • Enable 	

Setting (Camera setup)	Compatible cameras
<i>[Heater]</i>	<ul style="list-style-type: none"> • M100 / M200 • (1 & 3) M300 • M400 • M500
<i>[Zoom lock]</i>	<ul style="list-style-type: none"> • (1) M300 • M400 • M500
<i>[Mirrored view]</i>	<ul style="list-style-type: none"> • M100 / M200 • M300 • M400 • M500
<i>[Camera name]</i>	<ul style="list-style-type: none"> • M100 / M200 • M300 • M400 • M500
<i>[Icon]</i>	<ul style="list-style-type: none"> • M100 / M200 • M300 • M400 • M500
<i>[Flip image vertical]</i>	<ul style="list-style-type: none"> • M100 / M200 • M300 • M400 • M500
<i>[UI language]</i>	<ul style="list-style-type: none"> • M300 • M400 • M500

Setting (Camera setup)	Compatible cameras
<i>[On-screen icons]</i>	<ul style="list-style-type: none"> • M300 • M400 • M500
<i>[Save default settings]</i>	<ul style="list-style-type: none"> • M300 • M400 • M500
<i>[Restore default settings]</i>	<ul style="list-style-type: none"> • M300 • M400 • M500
<i>[Self-tests and calibration]</i>	<ul style="list-style-type: none"> • M100 / M200 • M300 • M400 • M500
Pan/tilt test	<ul style="list-style-type: none"> • M400 • M500
Set elevation reference	<ul style="list-style-type: none"> • M400 • M500
Set forward position	<ul style="list-style-type: none"> • M100 / M200 • M300 • M400 • M500
Spotlight test	<ul style="list-style-type: none"> • M400 • M500

Setting (Camera setup)	Compatible cameras
<i>[Self-tests and calibration] (Thermal feed)</i>	<ul style="list-style-type: none"> • M100 / M200 • M300 • M400 • M500
IR test pattern	<ul style="list-style-type: none"> • N / A
Reset IR lens	<ul style="list-style-type: none"> • M100 / M200 • M400 • M500
Flat field correction	<ul style="list-style-type: none"> • M100 / M200 • M400 • M500
<i>[Restore factory settings]</i>	<ul style="list-style-type: none"> • M100 / M200 • M300 • M400 • M500
<ul style="list-style-type: none"> • Run factory restore 	<ul style="list-style-type: none"> • M300 • M400 • M500

Setting (Photo & Video recording)	Compatible cameras
<i>[Save files to]</i>	<ul style="list-style-type: none"> • M100 / M200 • M300 • M400 • M500
<ul style="list-style-type: none"> • List of connected SD cards 	<ul style="list-style-type: none"> • M300 • M400 • M500

Setting (ClearCruise™)	Compatible cameras
ClearCruise™ Augmented Reality (<i>Requires AR200</i>)	<ul style="list-style-type: none"> • M100 / M200 • M300
<i>[Augmented Reality]</i>	<ul style="list-style-type: none"> • M100 / M200 • M300
<ul style="list-style-type: none"> • Disable • Enable 	<ul style="list-style-type: none"> • M300

Setting (ClearCruise™)	Compatible cameras
<i>[AIS targets]</i>	<ul style="list-style-type: none"> • M100 / M200 • M300
<ul style="list-style-type: none"> • Disable • Enable 	<ul style="list-style-type: none"> • M300
<i>[Hide static targets]</i>	<ul style="list-style-type: none"> • M100 / M200 • M300
<ul style="list-style-type: none"> • Disable • Enable 	<ul style="list-style-type: none"> • M300
<i>[Waypoints]</i>	<ul style="list-style-type: none"> • M100 / M200 • M300
<ul style="list-style-type: none"> • Disable • Enable 	<ul style="list-style-type: none"> • M300
<i>[Chart objects]</i>	<ul style="list-style-type: none"> • M100 / M200 • M300
<ul style="list-style-type: none"> • Disable • Enable 	<ul style="list-style-type: none"> • M300
<i>[Cartography source]</i>	<ul style="list-style-type: none"> • M100 / M200 • M300
<ul style="list-style-type: none"> • Disable • Enable 	<ul style="list-style-type: none"> • M300
<i>[Compass]</i>	<ul style="list-style-type: none"> • M100 / M200 • M300
<ul style="list-style-type: none"> • Disable • Enable 	<ul style="list-style-type: none"> • M300
<i>[Range limit]</i>	<ul style="list-style-type: none"> • M100 / M200 • M300
<ul style="list-style-type: none"> • Disable • Enable 	<ul style="list-style-type: none"> • M300
ClearCruise™ Object Detection (Video Analytics)	<ul style="list-style-type: none"> • M100 / M200 • (4) M300
<i>[Highlight detected objects]</i>	<ul style="list-style-type: none"> • M100 / M200 • (4) M300
<ul style="list-style-type: none"> • Disable • Enable 	<ul style="list-style-type: none"> • (4) M300

Setting (ClearCruise™)	Compatible cameras
<i>[Beep on detection]</i>	<ul style="list-style-type: none"> • M100 / M200 • (4) M300
<ul style="list-style-type: none"> • Disable • Enable 	
<i>[Display estimated range]</i>	<ul style="list-style-type: none"> • M100 / M200 • (4) M300
<ul style="list-style-type: none"> • Disable • Enable 	
<i>[Detection threshold]</i>	<ul style="list-style-type: none"> • M100 / M200 • (4) M300
<ul style="list-style-type: none"> • 0–12 	

Setting (Camera motion)	Compatible cameras
<i>[Camera height above waterline]</i>	<ul style="list-style-type: none"> • M100 / M200 • M300 • M400 • M500
<ul style="list-style-type: none"> • Adjust value 	
<i>[Forward position]</i>	<ul style="list-style-type: none"> • M200 • M300 • M400 • M500
<ul style="list-style-type: none"> • Adjust position and Save 	
<i>[Man overboard]</i>	<ul style="list-style-type: none"> • M200 • M300 • M400 • M500
<ul style="list-style-type: none"> • Disable • Enable 	
<i>[Dangerous AIS target]</i>	<ul style="list-style-type: none"> • M200 • M300 • M400 • M500
<ul style="list-style-type: none"> • Disable • Enable 	

Setting (Camera motion)	Compatible cameras
<i>[Dangerous MARPA target]</i>	<ul style="list-style-type: none"> • M200 • M300 • M400 • M500
<ul style="list-style-type: none"> • Disable • Enable 	
<i>[Vertical stabilization]</i>	<ul style="list-style-type: none"> • M300 • M400 • M500
<ul style="list-style-type: none"> • Disable • Enable 	
<i>[Horizontal stabilization]</i>	<ul style="list-style-type: none"> • M300 • M400 • M500
<ul style="list-style-type: none"> • Disable • Enable 	
<i>[Enable scan]</i>	<ul style="list-style-type: none"> • M200 • M300 • M400 • M500
<ul style="list-style-type: none"> • Disable • Enable 	
<i>[Scan width]</i>	<ul style="list-style-type: none"> • M200 • M300 • M400 • M500
<ul style="list-style-type: none"> • Disable • Enable 	
<i>[Scan speed]</i>	<ul style="list-style-type: none"> • M200 • M300 • M400 • M500
<ul style="list-style-type: none"> • Disable • Enable 	

Setting (Page)	Compatible cameras
<i>[Edit data overlays]</i>	<ul style="list-style-type: none">• M100 / M200
<ul style="list-style-type: none">• List of data overlays	<ul style="list-style-type: none">• M300• M400• M500
<i>[Fullscreen mode]</i>	<ul style="list-style-type: none">• M100 / M200
<ul style="list-style-type: none">• Disable• Enable	<ul style="list-style-type: none">• M300• M400• M500

CHAPTER 29: CLEARCRUISE

CHAPTER CONTENTS

- 29.1 ClearCruise™ features — page 457
- 29.2 Camera setup — page 458
- 29.3 AR200 setup for Augmented Reality — page 461
- 29.4 ClearCruise™ Object Detection (Video Analytics) overview — page 461
- 29.5 Augmented Reality (AR) overview — page 463
- 29.6 Augmented Reality flags — page 463
- 29.7 ClearCruise settings (Augmented Reality) — page 466
- 29.8 Roll correction — page 467
- 29.9 AR200 Calibration (Linearization) — page 468

29.1 ClearCruise™ features

ClearCruise™ features are designed for enhancing situational awareness and aiding navigation.

ClearCruise™ technology provides 2 separate features, which are described in more detail throughout this chapter:

- Object Detection (Video Analytics)
- Augmented Reality (AR)

Object Detection

[Object Detection](Video Analytics) is a feature available for M100, M200, and M300 Series thermal cameras. Intelligent thermal analytics technology provides audible and visual alerts when “non-water” objects are identified in the scene. Vessels, obstacles, and navigation markers can all be automatically identified by the camera without the need for Chart or Radar data.

Compatible cameras for Object Detection

- Thermal Camera (M100, M200, or M300 Series), **running the latest available software version.**

Note: Visit www.raymarine.com/software to download the latest software for your camera.

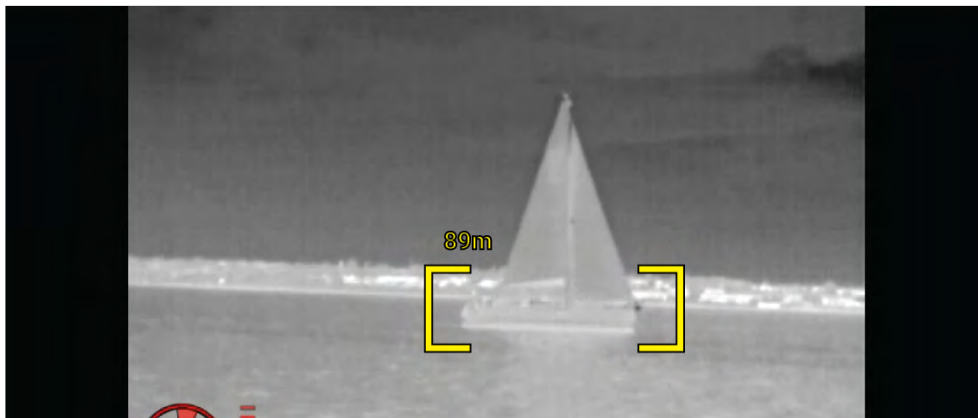

Note:

Weather conditions can cause the target's temperature, luminance, contrast or chrominance to be below a detectable range in relation to the background image. Therefore, the effectiveness of the ClearCruise Object Detection (Video Analytics) feature for distinguishing targets and non-targets is dependent on optimal scene conditions. It is recommended:

- The visible image is adjusted to contain good color, brightness and contrast;
- Accuracy can be improved by excluding irrelevant regions such as sun glare.

Augmented Reality

The *[Augmented Reality]* feature places layers of digital information directly over the top of the Video app's video feed. Data from the Chart app is used to generate informative text and images (flags) on the Video app. When calibrated correctly, ClearCruise™ Augmented Reality accurately overlays automatically-updating flags on the Video app so they overlap real-life objects.

Required components for Augmented Reality (IP cameras)

- AR200 Augmented Reality Sensor
- IP camera (CAM300, CAM210IP, or CAM220IP)

Required components for Augmented Reality (M-Series cameras)

- AR200 Augmented Reality Sensor
- M-Series camera (M100, M200 and M300 Series)

Important:

Cameras utilizing ClearCruise™ Augmented Reality are subject to an unstable image on rough waters.



Note: ClearCruise’s performance is dependent on environmental conditions and is not a replacement for maintaining a visual watch.

29.2 Camera setup

Before using the Augmented Reality features, it’s important to correctly install and setup your compatible camera.

Refer to your camera’s installation manual to determine the correct physical installation and connections for using the camera as part of an Augmented Reality system.

A number of additional camera-related settings and calibrations must be completed in the Video app before Augmented Reality features can be used:

- Camera height above the waterline.
- Camera direction.
- Camera horizontal field of view [not required for cameras which auto assign their field of view].
- Horizon calibration.

Note:

- The camera’s height above the waterline and camera’s view direction need to be physically measured for accurate camera installation.
- The camera’s horizontal field of view can be found in your camera’s installation manual specification.

Fixed camera calibration

Fixed mount cameras require calibration for Augmented Reality to function correctly.

1. For first time setup, either:
 - i. Select the *[Enter Details]* prompt in the Video app.
 - ii. Select the *[ClearCruise]* tab in the Video app’s Settings, *[Video app > Settings > ClearCruise.]* There will be a prompt to *[Enter Details]* using the *[Camera Installation]* page.
2. Go directly to the *[Camera Installation]* page in the Video app (*[Settings > Camera Setup > Camera Installation]*).
3. The *[Camera Installation]* page will offer a series of camera installation options which all need to be completed correctly.

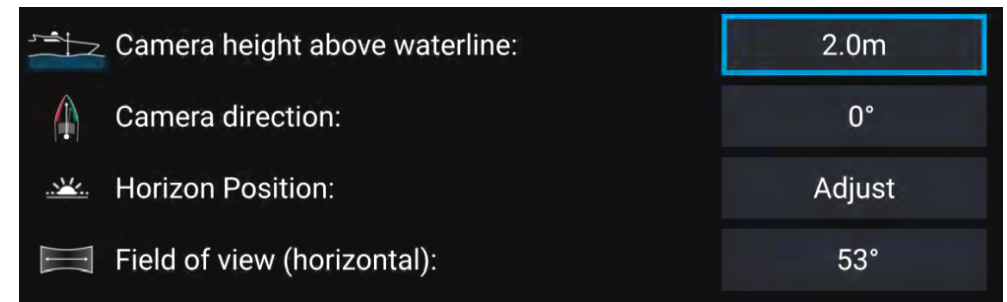

Note:

Incorrect physical camera installation and incorrect settings provided in the camera setup page could result in an inaccurate Augmented Reality overlay.

- To adjust the values of *[Camera height above waterline]*, *[Camera direction]* and *[Field of view]*, select the value boxes of each option and adjust using the arrows.

Menu item	Options
<i>[Camera height above waterline]</i>	<ul style="list-style-type: none"> • 0m to 50m • 0ft to 165ft
<i>[Camera direction]</i>	<ul style="list-style-type: none"> • 0° (Forward) (default) • 0° to 180°p (Port) • 0° to 180°s (Starboard)
<i>[Field of view]</i>	<ul style="list-style-type: none"> • 30° to 120° • [CAM210IP – 53°] • [CAM220IP – 93°] • [CAM300 – 90° recommended]

- To Calibrate horizon, use the *[up]*, *[down]*, *[rotate left]* and *[rotate right]* arrow keys until the red line is placed on the horizon. When the line is in position, select *[Save]*.

Important:

Calibrating the horizon correctly is essential for accurate Augmented Reality overlay. Calibrating on calm water and in clear sight of the horizon is recommended.

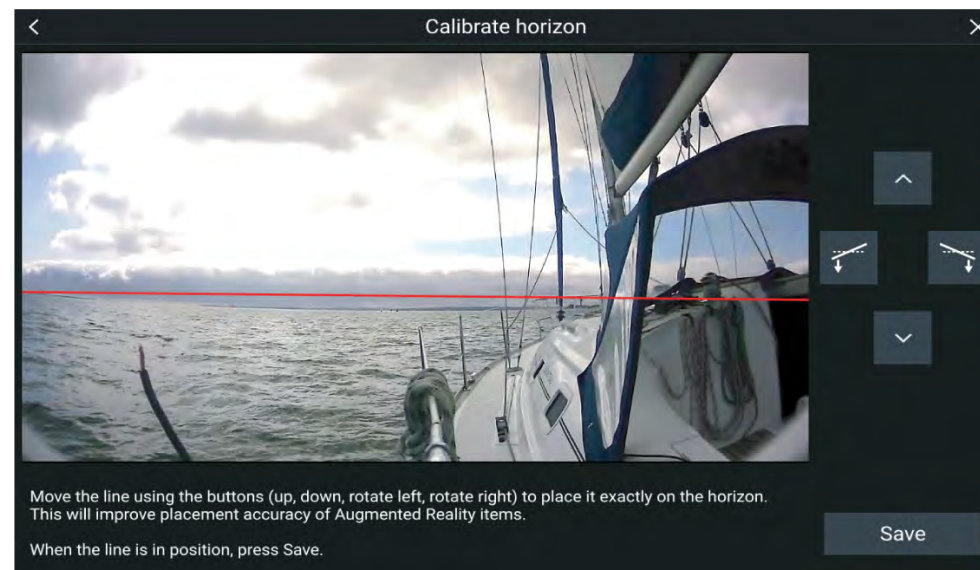

Pan and Tilt camera calibration

Pan and Tilt cameras require calibration for Augmented Reality to function correctly.

1. For first time setup, either:
 - i. Select the *[Enter Details]* prompt in the Video app.
 - ii. Select the *[ClearCruise]* tab in the Video app's Settings: *[Video app > Settings > ClearCruise]*. There will be a prompt to *[Enter Details]* using the *[Camera Installation]* page.
2. Go directly to the *[Camera Installation]* page in the Video app (*[Settings > Camera Setup > Camera Installation]*).
3. The *[Camera Installation]* page will offer a series of camera installation options which all need to be completed correctly.

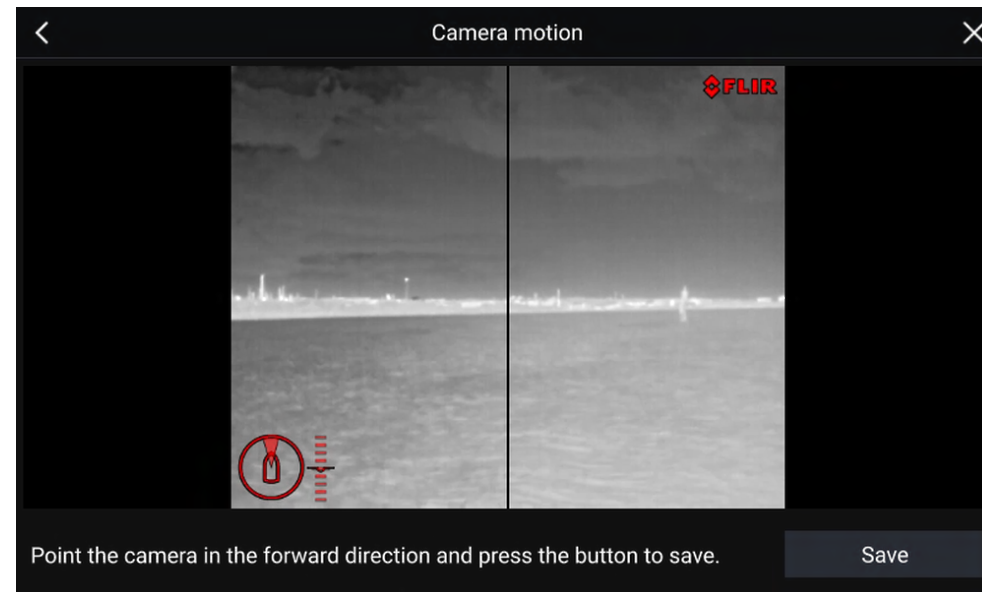
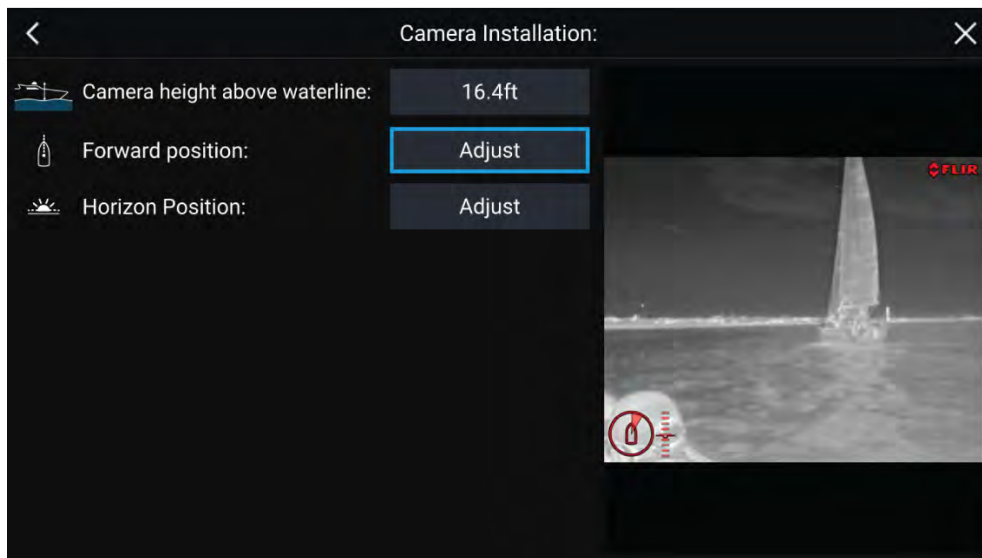

Note:

Incorrect physical camera installation and incorrect settings provided in the camera setup page could result in an inaccurate Augmented Reality overlay.

- To adjust the values of *[Camera height above waterline]* select the value box and adjust using the arrows.

Menu item	Options
<i>[Camera height above waterline]</i>	<ul style="list-style-type: none"> • 0m to 50m • 0ft to 165ft

- To Calibrate the camera's *[Forward Position]*, adjust the camera direction so that the vertical black line is positioned directly forward, parallel to your vessel's forward position.



Important:

- Calibrating the camera's forward position is essential for accurate Augmented Reality overlay when the camera pans and tilts. Calibrating on calm water and with a clear view of the front of your vessel is recommended.
- Certain cameras display a camera direction indicator, which can help identify when the camera is facing directly forward.

- To Calibrate the camera's *[Horizon position]*, use the arrow keys to align the horizontal red line so that it is level with the horizon.
- Pan and tilt the camera 360° during calibration to ensure that the horizon line has been positioned correctly.



29.4 ClearCruise™ Object Detection (Video Analytics) overview

The Object Detection (Video Analytics) features provide audible and visual alerts when “non-water” objects are identified by connected M100/M200/M300 Series cameras.

Objects that visually differ from the water will be identified by the camera as a “non-water” object.

The following features are available with Object detection:

- *[Highlight detected objects]*— Enables/disables object highlighting, which automatically identifies and highlights “non-water” objects.
- *[Beep on detection]*— Enables/disables an audible beep when an object is detected (*[Highlight detected objects]* must be enabled)
- *[Display estimated range]*— Enables/disables display of an object’s estimated range from your vessel. *[Highlight detected objects]* must be enabled, and the object must be closer than approximately 100 m (~300 ft).

Important:

Calibrating the horizon correctly is essential for accurate Augmented Reality overlay. Calibrating on calm water and in clear sight of the horizon is recommended.

Note:

The minimum range for estimated range is 5 m (16.4 ft), objects within this range will still be highlighted but will not display an estimated range.

29.3 AR200 setup for Augmented Reality

Before using the Augmented Reality features, it’s important to correctly install and setup the AR200 Augmented Reality sensor.

Refer to the AR200 Installation manual (87372) to determine the correct physical installation and connections for using the AR200 as part of an Augmented Reality system.

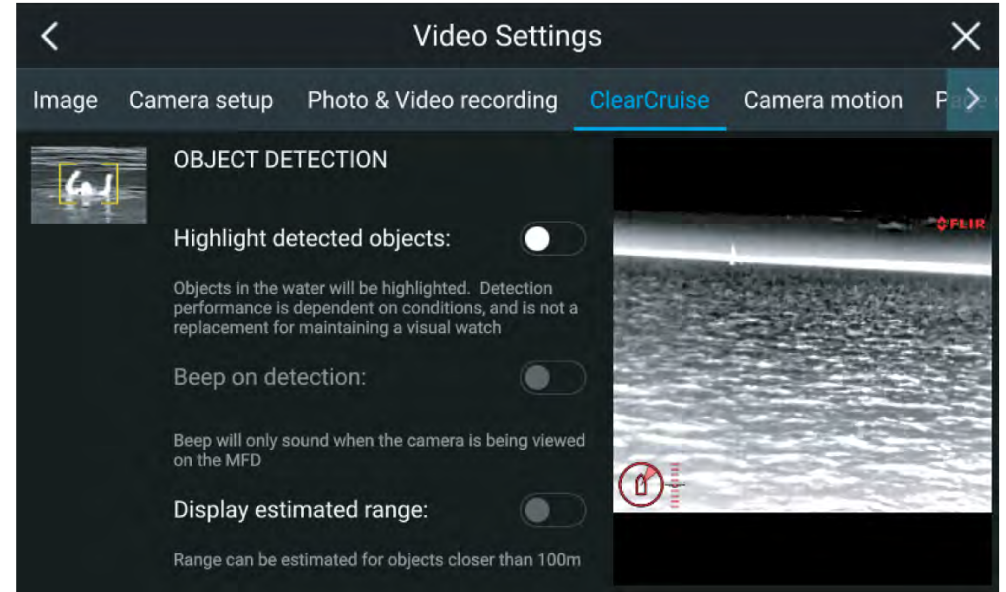
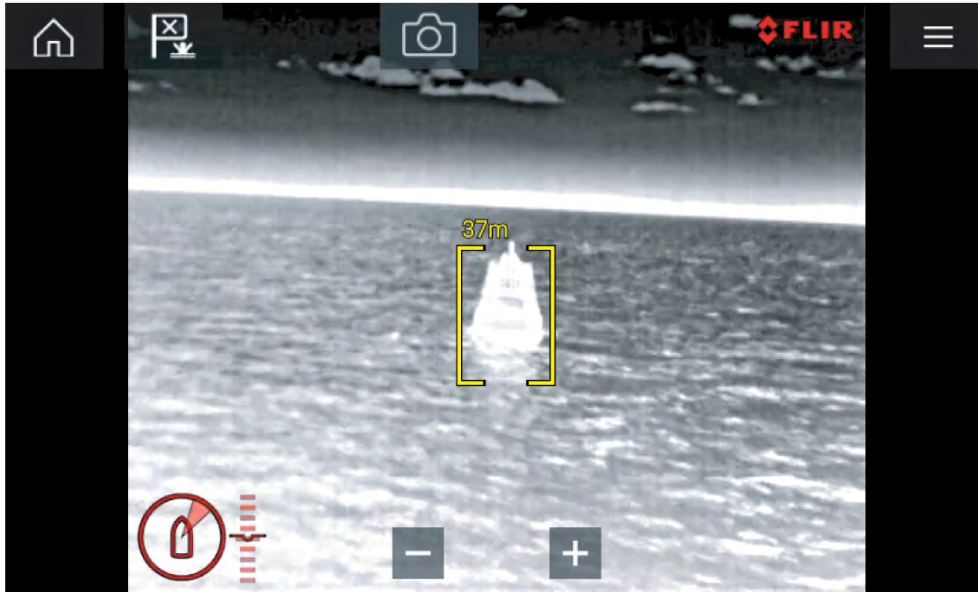

Setting	Description
<i>[Highlight detected objects]</i>	Enables/disables object highlighting.
<i>[Beep on detection]</i>	Enables/disables an audible beep when an object is detected (<i>[Highlight detected objects]</i> must be enabled).
<i>[Display estimated range]</i>	Enables/disables display of an object's estimated range from your vessel (<i>[Highlight detected objects]</i> must be enabled, and the object must be closer than approximately 100 m (~300 ft).

Important:
 ClearCruise Object Detection (Video Analytics) is only compatible with cameras that are positioned upright. ClearCruise Object Detection will not function with cameras that are upside down and have vertical flip enabled.



- Object detection can be particularly useful at night or visually limiting environments such as storms or fog.
- In the event of an emergency, such as man overboard, Object detection could be a useful aid that helps to identify and predict the distance from the MOB.

Note:
 ClearCruise's performance is dependent on conditions and is not a replacement for maintaining a visual watch.

ClearCruise settings (Object Detection / Video Analytics)

Object Detection (Video Analytics) features and settings can be enabled and disabled in the *[ClearCruise]* tab in the Video app.

[Video app > Settings > ClearCruise]

29.5 Augmented Reality (AR) overview

ClearCruise™ Augmented Reality uses data from the display's Chart app and displays this data in realtime as an overlay in the Video app.

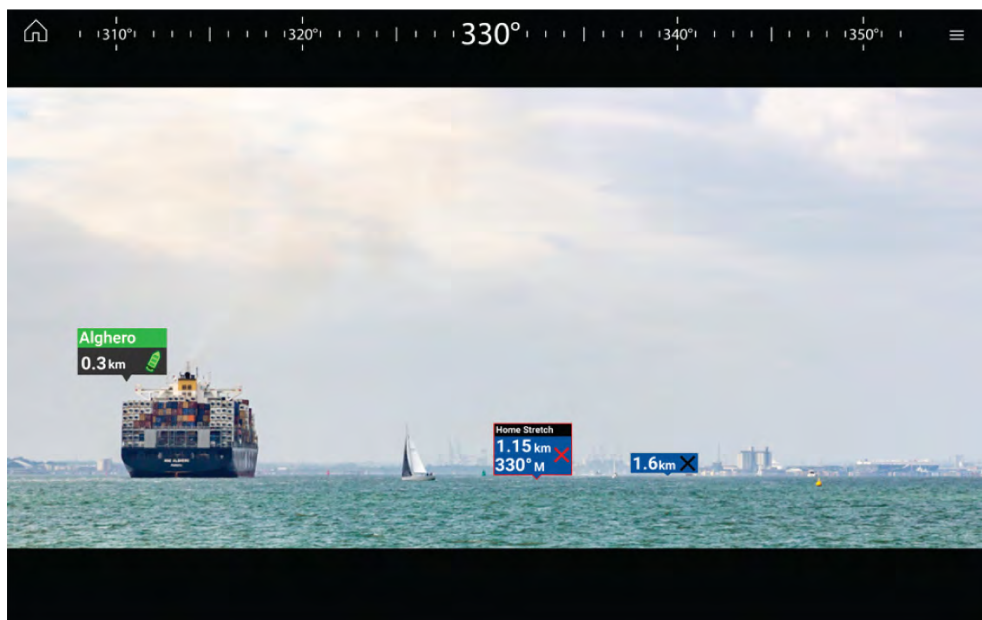

The [Augmented Reality] feature places layers of digital information directly over the top of the Video app's video feed. Data from the Chart app is used to generate informative text and images (flags) on the Video app. When calibrated correctly, ClearCruise™ Augmented Reality accurately overlays automatically-updating flags on the Video app so they overlap real-life objects.

The Augmented Reality feature requires an Axiom® or , Axiom® 2 display, an AR200 sensor, and a compatible camera.

Note:

- The Augmented Reality feature requires correct camera calibration for accurate image overlay.
- The Augmented Reality feature serves as an aid to navigation and situational awareness only, and should not be solely relied on for precise navigation. **Always maintain a visual watch.**

Important:

Rear-facing cameras with a flipped or mirrored image may not place Augmented Reality content as accurately as a forward-facing camera.

29.6 Augmented Reality flags

ClearCruise™ Augmented Reality displays AIS Targets, Waypoints and Chart Objects as individual Augmented Reality [Flags] in the Video app.

All flags display an icon and your vessel's distance from the target's location.

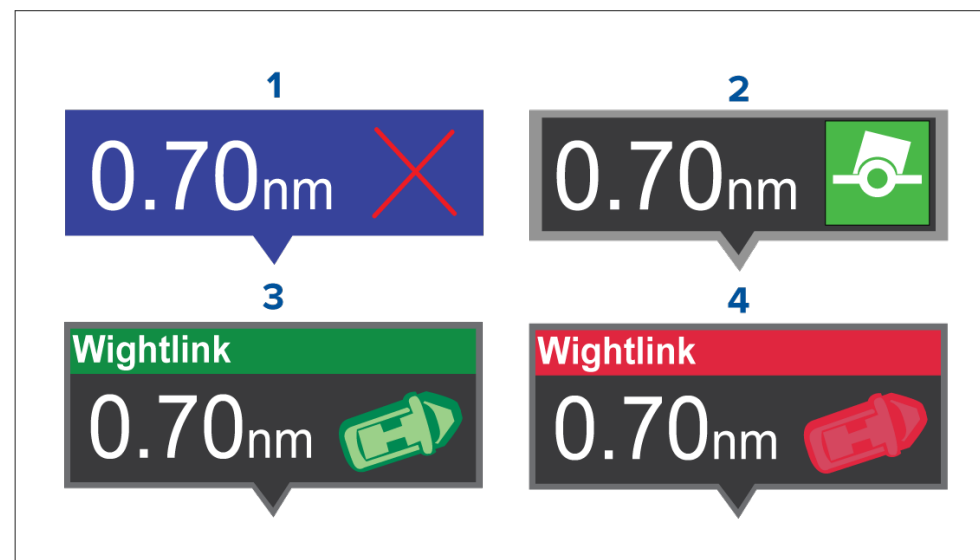

1. Waypoint flag
2. Chart Object flag (buoy)
3. AIS Target flag (passenger ferry; icon points in the direction of travel relative to the camera feed)
4. Dangerous AIS Target flag (passenger ferry; icon points in the direction of travel, relative to the camera feed)

Note:

AIS flags update periodically; however, accurate placement is not guaranteed.

- AIS Targets, Waypoints and Chart Object flags can be quickly enabled / disabled via buttons in the Video app.
- The maximum range within which flags are automatically shown can also be adjusted in the Video app.



Selected flags

Augmented Reality flags in the Video app can be selected (highlighted), providing access to more information about the object and additional features.

A flag is an onscreen visual overlay element displayed in the Video app when the Augmented Reality features are enabled. A flag represents an object from the Chart application: e.g. AIS target, Waypoint, or other chart object.

When a flag is selected, the corresponding object is also highlighted in the Chart app. Conversely, selecting an object in the Chart app highlights the corresponding flag in the Video app.

Only one flag may be selected at a time.

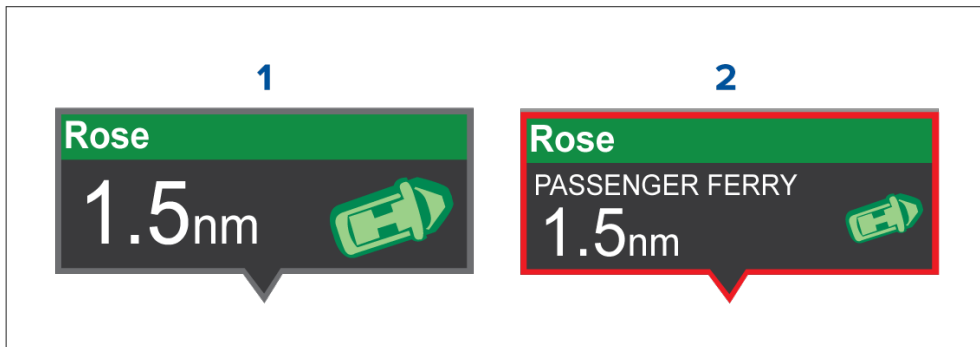

1. AIS Flag
2. Selected AIS Flag

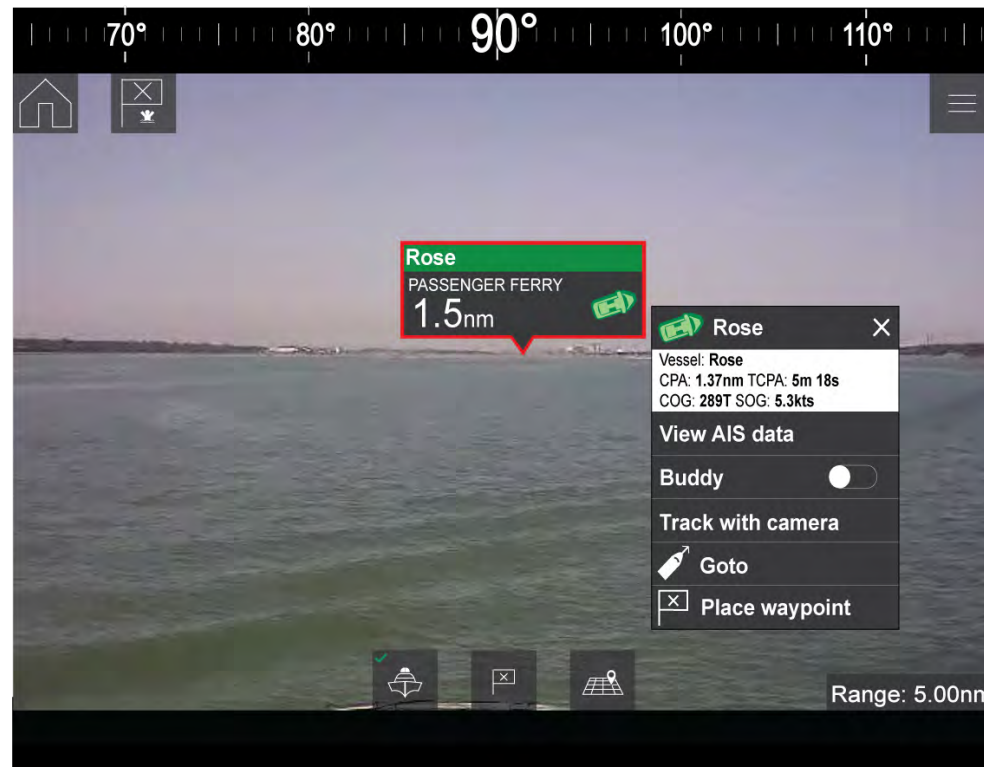

Selecting a flag highlights it in red and provides additional information about the object in a context menu. The menu also provides additional features. The range of features available in the context menu depends on the type of object selected:

[AIS Target Flag]

Option	Description
<i>[AIS Target name]</i>	The name of the target vessel.
<i>[Target data]</i>	Vessel (name), CPA, TCPA, COG, SOG.
<i>[View AIS data]</i>	Displays the AIS data transmitted by the target vessel.

Option	Description
<i>[Buddy (toggle ON/OFF)]</i>	Add the vessel to your “Buddy List”, with the option to rename it. The Buddy feature enables you to add AIS-equipped friends and regular contacts to a “Buddy List” on your MFD. As soon as a vessel on your Buddy List comes within range of your AIS receiver, the onscreen vessel icon changes to indicate this.
<i>[Goto]</i>	The Chart app will plot a direct route to the last known location of the target.
<i>[Place waypoint]</i>	The Chart app will place a waypoint at the last known location of the target.

[Waypoint Flag]

Option	Description
<i>[Waypoint name]</i>	The name of the waypoint.
<i>[Target data]</i>	Lat, Lon, Rng, Brg.
<i>[Goto]</i>	The Chart app will plot a direct route to the last known location of the target.
<i>[Delete]</i>	Delete the waypoint.
<i>[Edit]</i>	Edit the waypoint’s Name, Symbol, Group, Position, and add a Comment.

[Chart Object Flag]

Option	Description
<i>[Chart Object name]</i>	The name of the chart object.
<i>[Target data]</i>	Lat, Lon, Rng, Brg.
<i>[Goto]</i>	The Chart app will plot a direct route to the last known location of the target.

Goto flag

Selecting *[Goto]* on a selected Augmented Reality flag will plot a direct course to the flag’s last known location.

A *[Goto]* flag will appear in the last known location of the selected flag in both the Video and Chart apps, and in the Video app’s *[Compass bar]*. The flag is displayed with a Goto icon, as a blue copy of the original flag.

Selecting the *[Goto]* flag makes it a selected flag, and also displays a context menu providing more information about the location of the flag, and the option to stop a goto action.

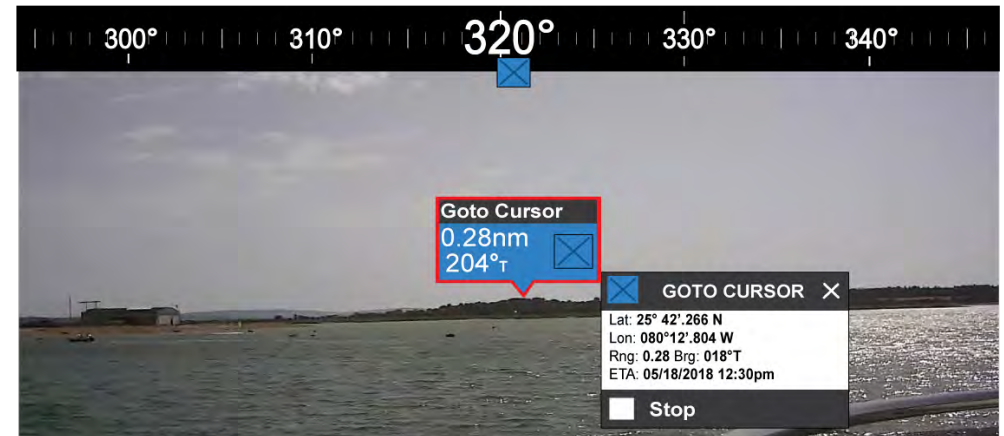

- Selecting *[Stop]* removes the Goto flag from the Video app and Chart app.
- If the camera loses sight of the *[Goto]* flag, it will display red and green navigational arrows on the *[Compass bar]*, indicating whether you need to turn port or starboard to regain sight of the flag. However, this only works if the camera is forward-facing.

29.7 ClearCruise settings (Augmented Reality)

Augmented Reality settings can be edited in the *[ClearCruise]* tab in the Video app.

Setting	Description
<i>[AIS labels]</i>	Enables/disables the display of other vessels as Augmented Reality flags (requires AIS).
<i>[Hide static targets]</i>	Enables/disables the display of AIS targets travelling under 2 knots (requires AIS).
<i>[Waypoints]</i>	Enables/disables the display of Waypoint Augmented Reality flags.
<i>[Chart objects]</i>	Enables/disables the display of Chart objects (requires compatible charts).
<i>[Cartography source]</i>	Select the cartography source that the ClearCruise™ features will use for the display of chart objects in the Video app Augmented Reality features. (Requires compatible charts).
<i>[Compass]</i>	Enables/disables the display of the Compass bar in the Video app.
<i>[Range limit]</i>	Sets the maximum range at which the camera will detect and display Augmented Reality flags. This range is displayed visually in the Chart app with the “FOV cone”. Refer to: p.242 – Field of View . For the maximum range supported by your camera, refer to: p.466 – Range limit

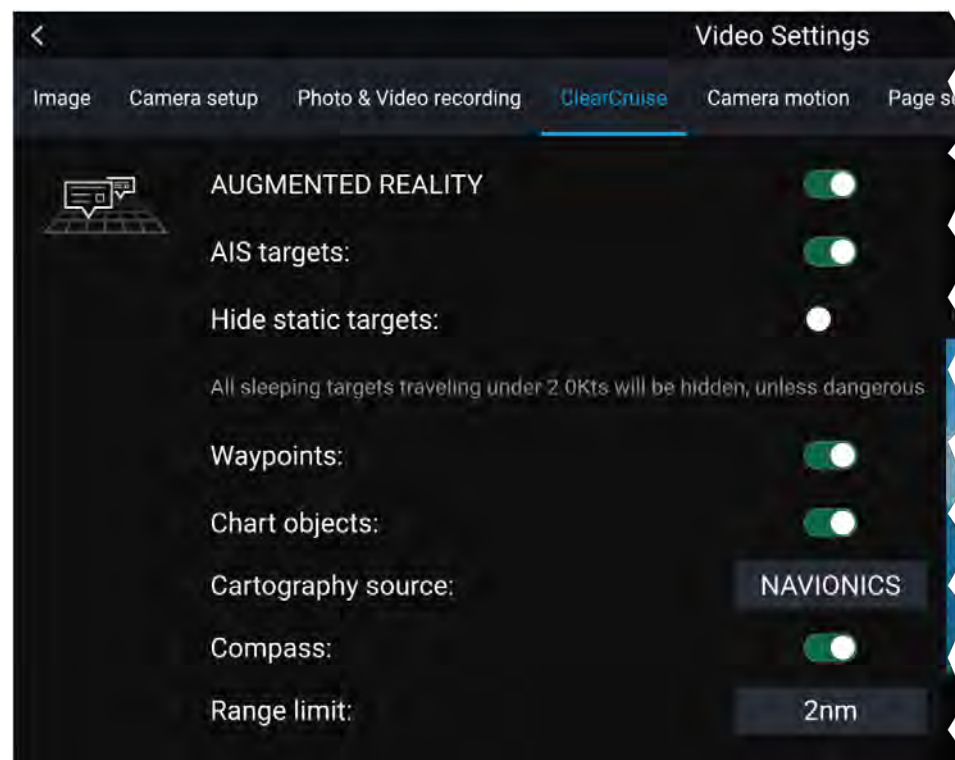

Note:

The variety of chart objects is dependent on the selected cartography source. For more information on different cartography sources, refer to: [p.239 – Find nearest](#)

Range limit

The Range Limit is the maximum range at which ClearCruise™ can display AIS targets, Waypoints and Chart Object flags in the Video app.

The range limit can be checked using the Field of View (FOV) cone in the Chart app. All AIS targets, Waypoints and Chart Objects within the area of coverage of the FOV cone can be displayed as Augmented Reality flags in the Video app. For more information, refer to: [Field of View](#)

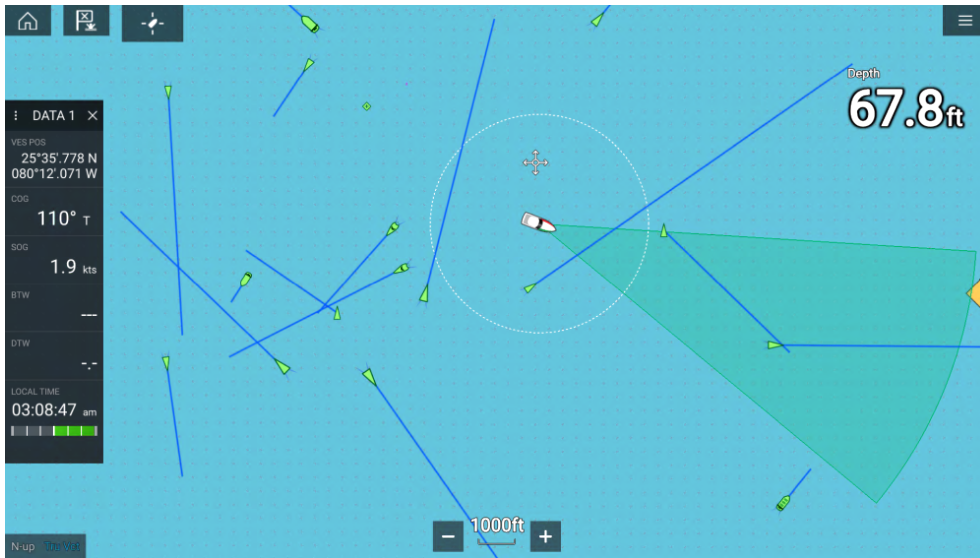

Note:

Some chart objects just outside of the FOV cone might still display in the Video app as flags.

You can specify this range limit manually in the Video app: *[Video Settings > ClearCruise tab]*. Any adjustments you make will be reflected in the FOV cone display in the Chart app.

29.8 Roll correction

Roll Correction automatically adjusts the Video app image when the vessel tilts (rolls) to port or starboard.

Note:

Roll correction is only available with IP cameras.

Roll Correction can be enabled/disabled in the Video app: *[Settings > Image]*.

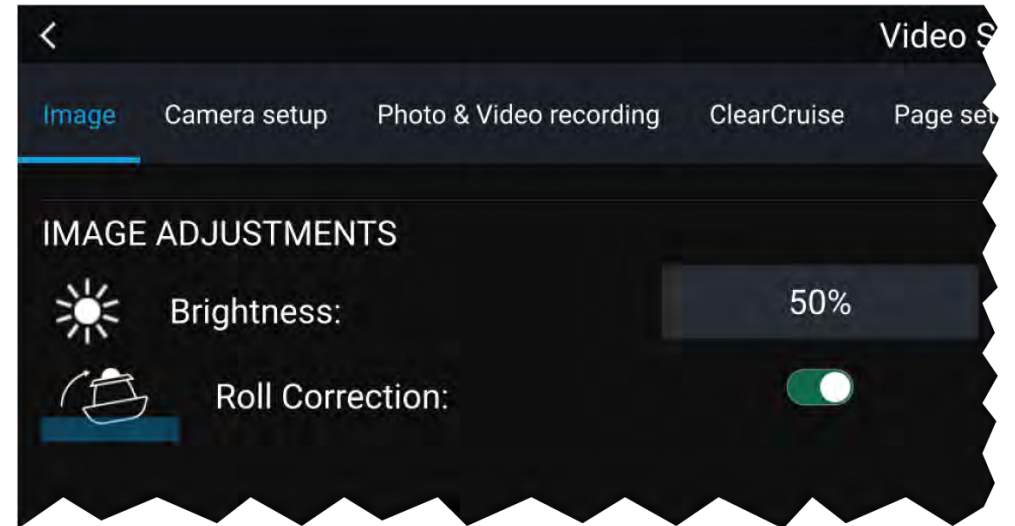

When enabled, the Roll Correction feature accounts for the boat tilting and stabilizes the video feed accordingly. This means that the video feed's horizon will be parallel with the actual horizon. When disabled, the video feed will tilt with the boat and the MFD screen.



1. Roll correction disabled

2. Roll correction enabled

29.9 AR200 Calibration (Linearization)

To enable accurate placement of Augmented Reality (AR) flags on the camera's video feed, the AR200's AHRS sensors need to compensate for local magnetic fields, as well as the Earth's magnetic fields.

Calibration is achieved using an automatic linearization process. The linearization process starts automatically after your vessel has turned approximately 100°, when travelling at a speed of between 3 to 15 knots. The linearization process requires no user input, however at least a 270° turn is required before linearization can be completed. The duration of the linearization process can be decreased by completing a full 360° turn, when travelling at a speed of between 3 to 15 knots. The linearization process can also be restarted at anytime.

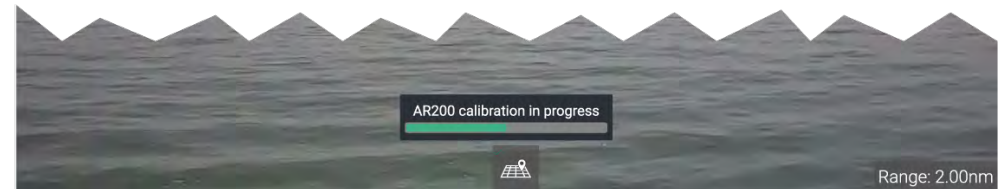

In the Video app the Linearization progress bar is displayed when linearization is in progress. The bar is filled to indicate completeness, and will turn Red if the process is paused or otherwise interrupted.

The time taken to complete the linearization process will vary according to the characteristics of the vessel, the AR200's installation location, and the levels of magnetic interference present at the time linearization is performed.

Magnetic interference can be caused by objects onboard your vessel, such as:

- Speakers
- Electronic equipment
- Electrical cabling
- Metal bulkhead or hull

Magnetic interference can also be caused by external objects in close proximity to your vessel, such as:

- Metal hulled vessels
- Underwater electrical cables

- Marine pontoons

Magnetic deviation

Magnetic deviation is the error induced in a compass caused by interference from local magnetic fields.

The automatic linearization process results in a deviation value being set for your AR200. If Augmented Reality flags in the Video app are not aligned with their onscreen objects, or the compass is out of alignment, you should check the AR200's current calibration settings. For instructions on how to do this, refer to the following section: [p.469 – AR200 calibration settings](#)

AR200 calibration settings

The calibration settings page provides access to the AR200's compass calibration options.

The AR200 calibration page can be accessed using your datamaster MFD; from the Homescreen select: *[Settings > Network > Data sources > Heading > AR200 > Calibrate]*.

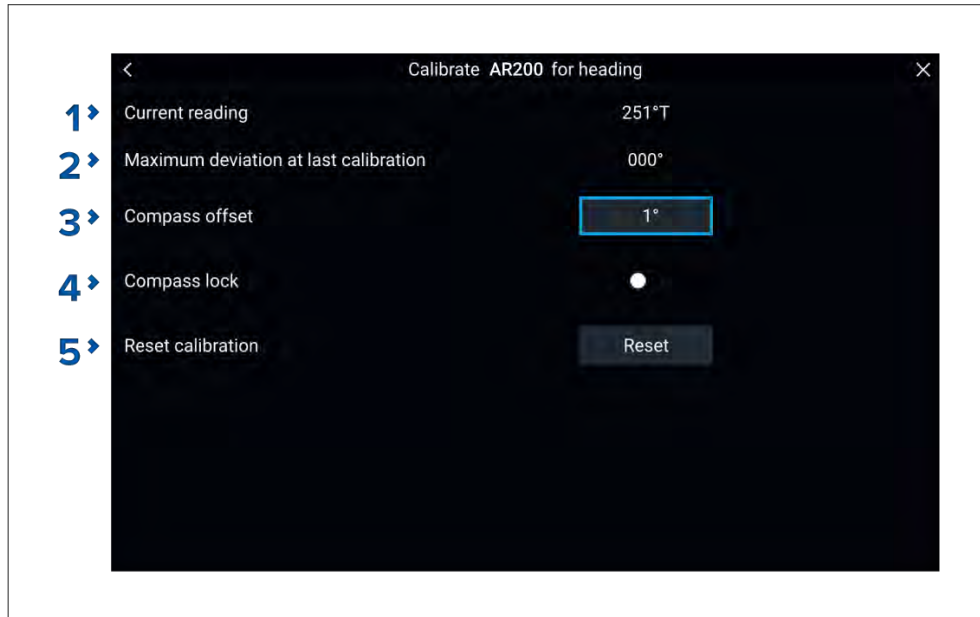

Item	Description
1	<i>[Current reading:]</i> The current heading reported by the AR200.
2	<i>[Maximum deviation at last calibration:]</i> The maximum deviation reported during the last linearization process. Important: If the <i>[Maximum deviation at last calibration]</i> is 45° or above, it is recommended that the AR200 unit is moved and re-installed in a location which is subject to less magnetic interference. <i>[Calibration in progress:]</i> While linearization is in progress the progress percentage is displayed.
3	<i>[Compass offset]</i> Once the linearization process has completed, it is possible that the heading value may be slightly out of alignment. This is common where installation space is limited and the AR200 is not properly aligned with your vessel's longitudinal axis. In this case, it is possible to manually adjust the Compass offset.
4	<i>[Compass lock]</i> When enabled, the Compass lock prevents the continual monitoring and adaptation of the compass linearization process. For more information, refer to: p.470 – Compass lock .
5	<i>[Reset calibration]</i> You can reset your AR200's current linearization settings by selecting <i>[Reset calibration]</i>

Continual monitoring and adaptation

To ensure optimum performance, after the initial linearization process is complete the unit continues to monitor and adapt the compass linearization to suit current conditions.

If the conditions for linearization are less than ideal, the automatic linearization process temporarily pauses until conditions improve again. The following conditions can cause the linearization process to temporarily pause:

- significant magnetic interference is present
- vessel speed too slow or too fast
- rate-of-turn too slow or too fast

Compass lock

Once you are satisfied with the compass accuracy, you can lock the setting to prevent the system from completing a further automatic linearization in the future.

This feature is particularly useful for vessels in environments that are exposed to strong magnetic disturbances on a regular basis (such as offshore wind farms or very busy rivers, for example). In these situations it may be desirable to use the Compass lock feature to disable the continuous linearization process, as the magnetic interference may build a heading error over time.

Note:

The compass lock may be released at any time, to allow the compass continual monitoring and adaptation to re-commence. This is particularly useful if planning a long voyage. The earth's magnetic field will change significantly from one geographical location to another, and the compass can continually compensate for the changes, ensuring you maintain accurate heading data throughout the voyage.

CHAPTER 30: YOUTUBE & YOUTUBE TV

CHAPTER CONTENTS

- 30.1 YouTube TV — page 472
- 30.2 YouTube — page 472
- 30.3 MFD controls — page 472

30.1 YouTube TV

The YouTube TV app allows you to watch live sports, shows and news directly on your MFD screen. The YouTube TV app can only be added as a Fullscreen app page.

Note:

- YouTube TV is only available in the United States of America.
- YouTube TV requires an internet connection and an active subscription to YouTube TV.

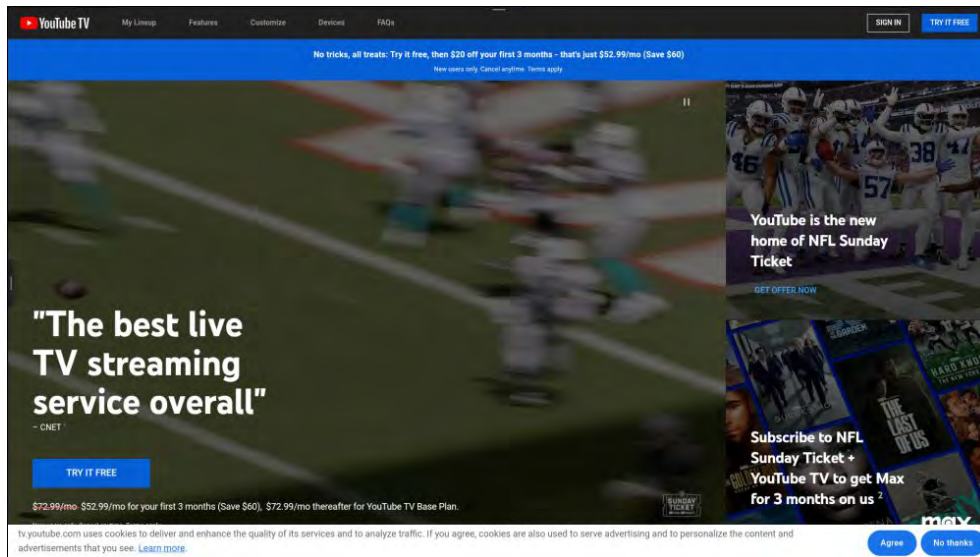

30.2 YouTube

The YouTube app allows you to browse and watch YouTube content directly on your MFD screen. The YouTube app can only be added as a Fullscreen app page.

Note:

- YouTube requires an internet connection

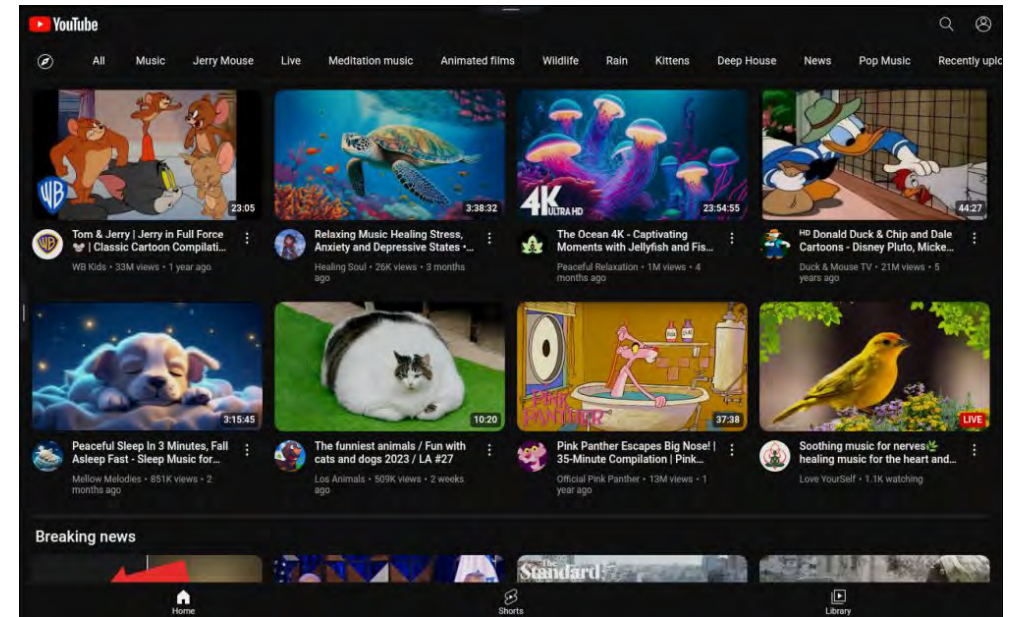

30.3 MFD controls

The MFD controls are automatically hidden when using the YouTube and YouTube TV apps.

To access the MFD controls when the YouTube or YouTube TV apps are displayed:



Warning: Distraction disclaimer

- The MFD/Chartplotter includes various entertainment apps. Whilst navigating do NOT let these apps distract your attention from safe navigation.
- Any distraction while navigating causes a lapse in concentration which increases the risk of collision. To avoid hazards you must give navigation your full attention at all times.

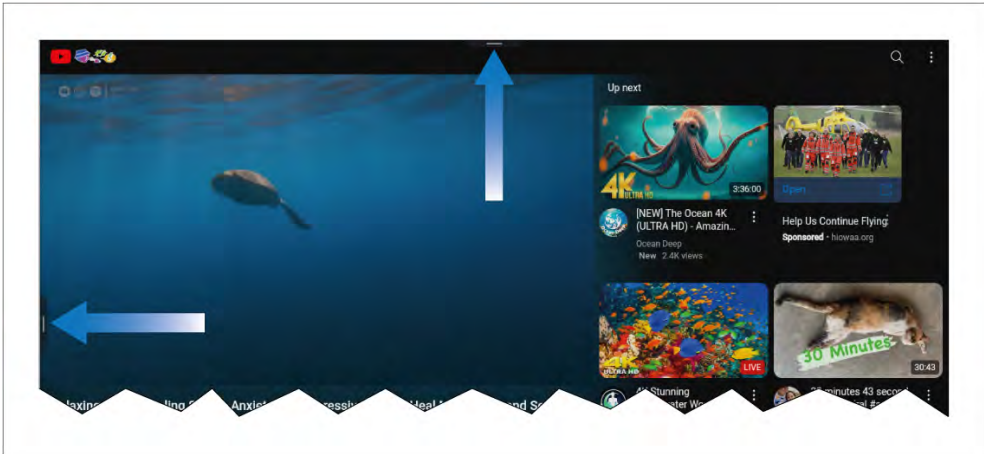

- Slide the Sidebar menu handle (located on the left side of the screen) to open the Sidebar.
- Pull down on the menu handle (located at the top of the screen) to access MFD controls:

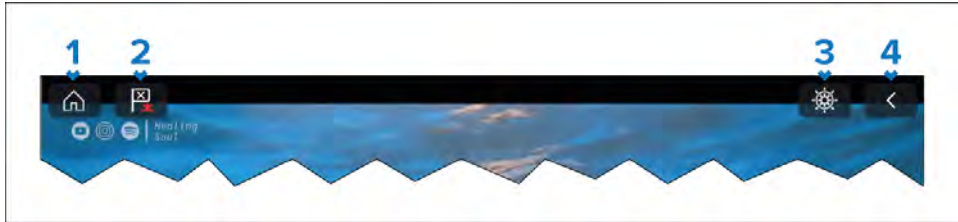

1. *[Home]* icon — Select to go back to the Homescreen.
2. *[Waypoint/MoB]* icon — Select to place a waypoint at the vessel's current location. Alternatively, a long touch of the *[Waypoint/MoB]* icon onscreen triggers the MoB alarm.
3. *[Pilot]* icon — Select to open the Pilot sidebar.
4. *[Back]* icon (only available when viewing a video). — Select to go back to the YouTube / YouTube TV homepage.

CHAPTER 31: AUDIO APP

CHAPTER CONTENTS

- [31.1 Audio app overview — page 475](#)
- [31.2 Opening the Audio app — page 479](#)
- [31.3 Getting started — page 480](#)
- [31.4 Audio app menu options — page 482](#)

31.1 Audio app overview

The Audio app can be used to control compatible entertainment systems that are connected to the same network as your MFD.

The Audio app can be displayed in Fullscreen and half screen portrait app pages.

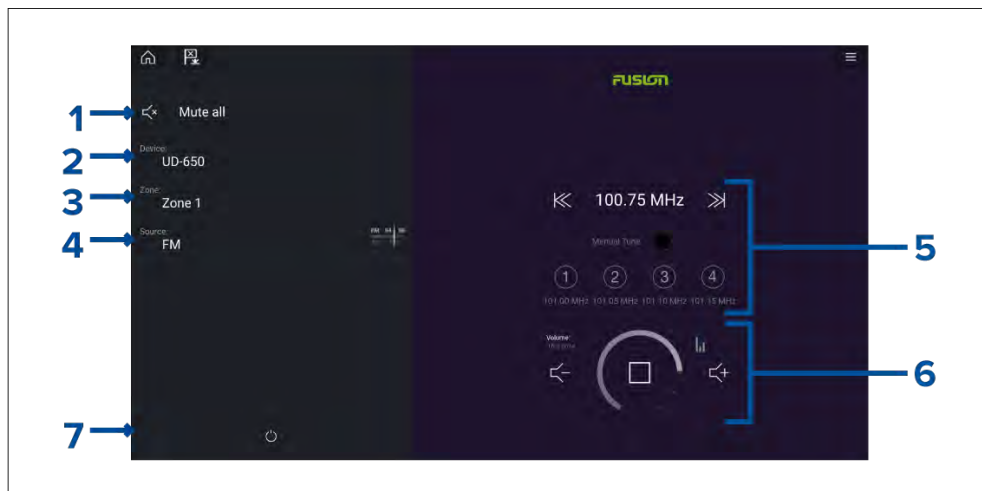

1. *[Mute All]*— Mutes all zones on all connected entertainment systems.
2. *[Device]*— On systems where more than 1 entertainment system are installed you can select which device the audio app controls.
3. *[Zone]*— On devices that support multiple zones you can select which zone the audio app controls.
4. *[Source]*— Change the media source for the selected entertainment system.
5. Audio source details and controls for currently selected source.
6. Volume and player controls for currently selected zone or multi-zone.
7. *[Power]*— Power on or off connected entertainment systems.



Warning: Distraction disclaimer

- The MFD/Chartplotter includes various entertainment apps. Whilst navigating do NOT let these apps distract your attention from safe navigation.
- Any distraction while navigating causes a lapse in concentration which increases the risk of collision. To avoid hazards you must give navigation your full attention at all times.

Compatible entertainment systems

The table below lists compatible entertainment systems which have been approved for use with the MFD Audio app. The Audio app can be used to control up to 3 entertainment systems from the same manufacturer. However, connecting entertainment systems from Fusion and Rockford Fosgate at the same time is NOT supported.

SiriusXM receivers

Model number	Raymarine part number	Supported Network connection
SR150	E70161	Ethernet / RayNet
SR200	E70499	Ethernet / RayNet

Rockford Fosgate entertainment systems

Model number	Raymarine part number	Supported Network connection
RMX-2	E70397	NMEA 2000
RMX8DH	E70394	NMEA 2000
RMX8BB	E70395	NMEA 2000
RMX5CAN	E70396	NMEA 2000

Fusion entertainment systems

Model number	Supported Network connection
AV750	NMEA 2000 Ethernet
AV755	NMEA 2000 Ethernet
BB100	NMEA 2000
BB300	NMEA 2000
RA70	NMEA 2000
RA70N	NMEA 2000
RA205	NMEA 2000
RA670	NMEA 2000 Ethernet
RA770	NMEA 2000 Ethernet
SRX400	Ethernet
UD750	NMEA 2000 Ethernet
UD755	NMEA 2000 Ethernet

JL Audio



Model number	Supported Network connection
MM50	NMEA 2000
MM100s-BE	NMEA 2000
MMR-40	NMEA 2000





Note:

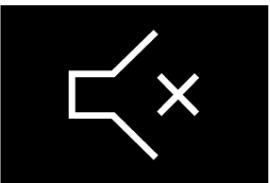
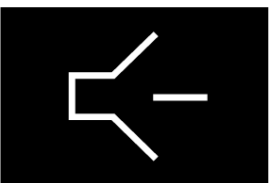



Connecting entertainment systems from Fusion and Rockford Fosgate at the same time is not supported.

Audio app controls

Audio player controls

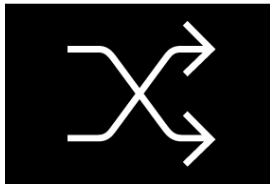
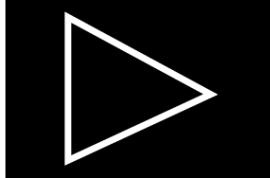

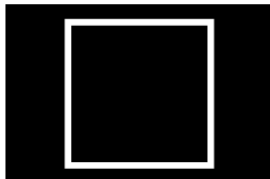
Icon	Description
	<i>[Power Off]</i> Powers off the Entertainment system.
	<i>[Mute All]</i> Mutes all audio zones.
	<i>[Volume Down]</i> Decreases volume for current zone.
	<i>[Volume Up]</i> Increases volume for current zone.
	<i>[Forwards]</i> <ul style="list-style-type: none"> • Skip to the next track (USB and Bluetooth) • Seek/Search Forward (Radio)
	Note: Control is not available from SiriusXM device.

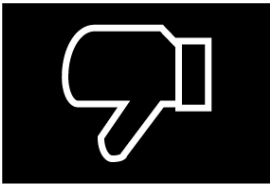
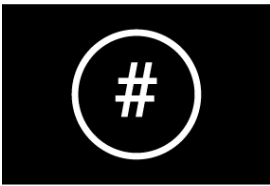

Icon	Description
	<p><i>[Backwards]</i></p> <ul style="list-style-type: none"> • Skip back to beginning of current track (USB and Bluetooth) • Seek/Search Backward (Radio) <hr/> <p>Note: Control is not available from SiriusXM device.</p>
	<p><i>[Manual Tune]</i></p> <ul style="list-style-type: none"> • On — (enables Forwards and Backwards icons for manual tuning) • Off
	<p><i>[Tune Up]</i> Manually searches up for radio stations/channels.</p> <hr/> <p>Note: Control is not available from SiriusXM device.</p>
	<p><i>[Tune Down]</i> Manually searches down for radio stations/channels.</p> <hr/> <p>Note: Control is not available from SiriusXM device.</p>
	<p><i>[Repeat]</i></p> <ul style="list-style-type: none"> • Off • Repeat Track • Repeat All

Icon	Description
	<p><i>[Shuffle]</i></p> <ul style="list-style-type: none"> • On • Off
	<p><i>[Play]</i> Select to commence playback.</p>
	<p><i>[Pause]</i> Select to Pause playback.</p>
	<p><i>[Stop]</i> Select to Stop (Mute) Radio devices.</p>
	<p><i>[Like]</i> Like a track (Pandora only).</p>

Icon	Description
	<i>[Dislike]</i> Dislike a track (Pandora only).
	<i>[Radio presets]</i> Save your favorite radio stations/channels to 4 preset buttons. Press and hold to save, press once to change to saved station/channel.
	Note: Control is not available from SiriusXM device.

Standard app controls

Icon	Description
	<i>[Menu]</i> Opens the app menu.
	<i>[Home]</i> Takes you to the Homescreen.

Icon	Description
	<i>[Waypoint / MOB]</i> Place waypoint / activate Man overboard (MOB) alarm.
	<i>[Pilot]</i> Opens and closes the Pilot Sidebar

Audio sidebar

With compatible audio equipment connected the Audio sidebar is available which enables you to control your audio system from an MFD app.

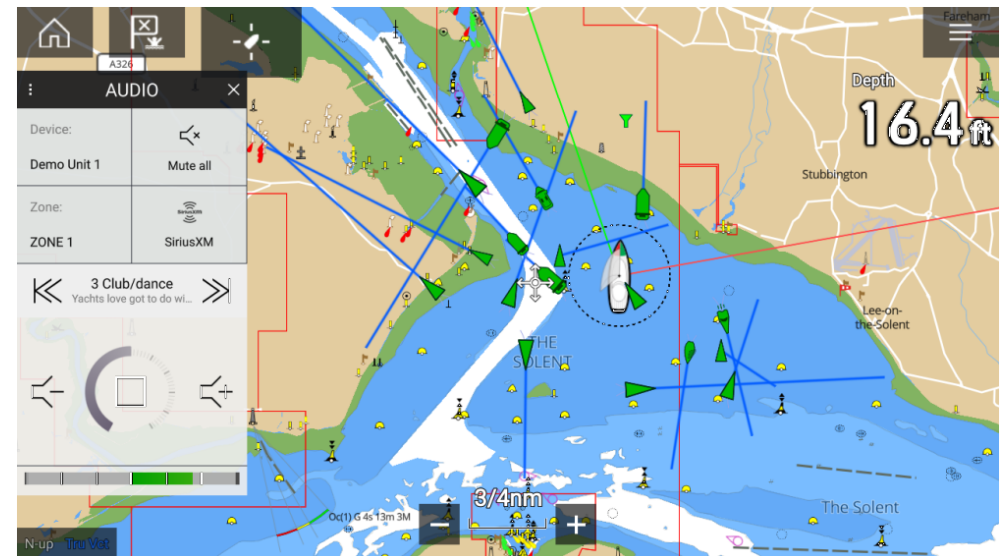

The Audio sidebar includes the following controls:

- Audio device selection.
- Zone selection.
- Source selection

- Track/Station selection.
- Volume controls.

31.2 Opening the Audio app

The Audio app is opened by selecting an app page from the Homescreen that includes the Audio app.

Pre-requisites:

1. Ensure your Entertainment system(s) are compatible by checking the latest details available on the Raymarine website. If in doubt please contact an authorized Raymarine dealer for advice.
2. Ensure you have installed your Entertainment system(s) in accordance with the documentation that was supplied with the system.

The Audio app will open in 1 of 3 states:

Audio app displayed

If your Entertainment system is powered up and operational then the player controls are displayed and can be used to control your system.

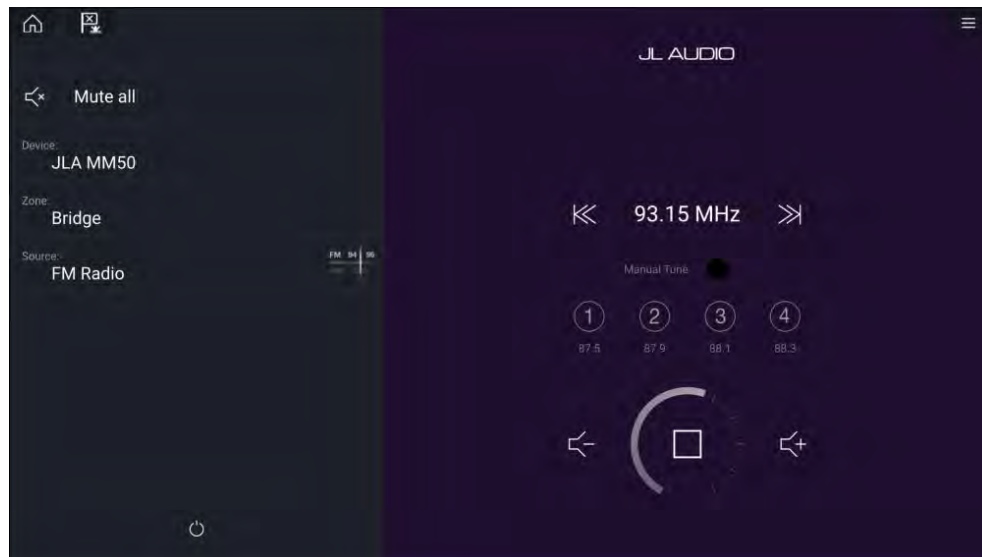

Entertainment system powered off

If all Entertainment systems are powered off then a Power icon is displayed for each connected system. An icon is also displayed to power on All systems. Selecting the [Power icon] will switch your Entertainment system on. Selecting the All icon will power on all connected systems.

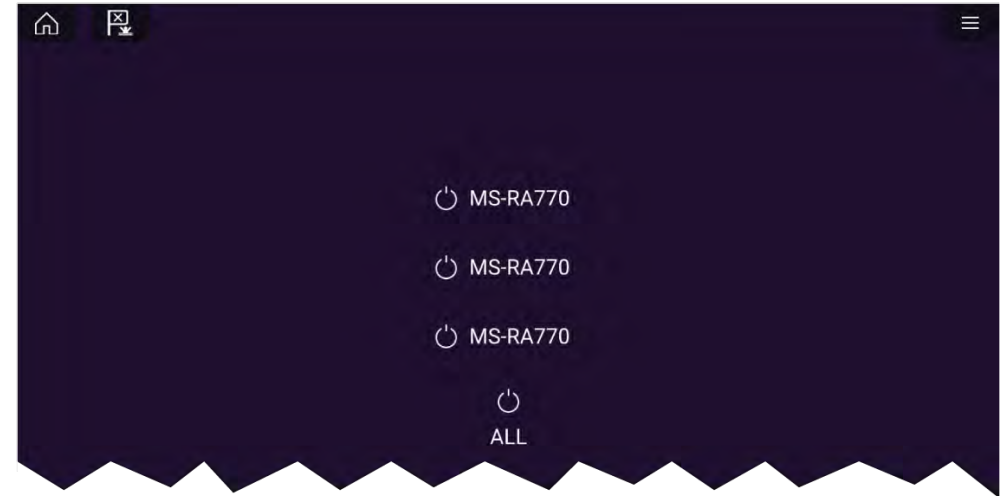

No audio devices found

If the Audio app is opened soon after powering on your MFD, the '**No audio device found**' message may be displayed whilst the network is being established. If the message is displayed for more than 10 seconds, your MFD cannot connect to your Entertainment system(s). Ensure network and power connections to your Entertainment system(s) and MFD are correct and free from damage and then power cycle your system. If the Entertainment system(s) are still not displayed then refer to your equipment's installation documentation for further troubleshooting information.

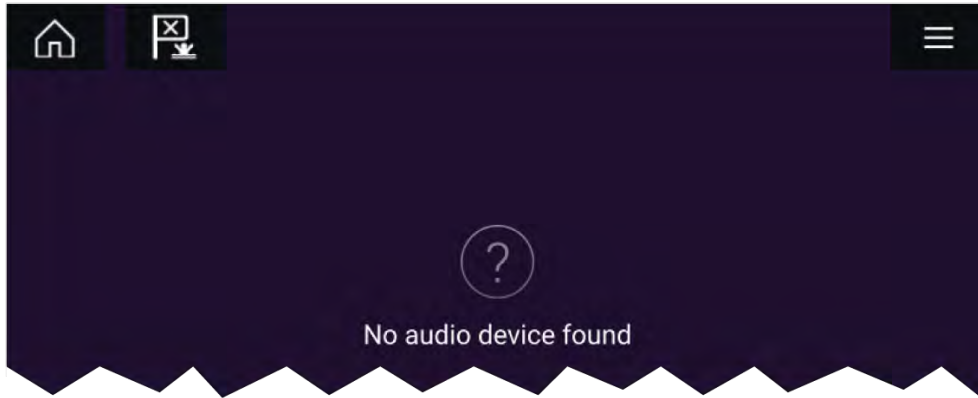

31.3 Getting started

Selecting an audio zone

If the select entertainment system supports multiple zones you can select which zone the audio app controls..

1. Select *[Zone]*.
The zone pop-over menu is displayed.
2. Select the zone you want to control.

Tip

Refer to the instructions provided with your entertainment system for details on naming your zones. This aids device and zone identification when multiple systems each with multiple zones are connected.

Selecting an audio source

Before you can select an audio source from your MFD, the source must already be available to your Entertainment system's main control unit ("head unit").

1. Select an audio source (mode) icon from the app *[Menu]*.

The currently selected zone will switch to the selected audio source. Depending on your entertainment system all zones will change and play the same audio source, or you may be able to play a different source on each zone. Check the instructions provided with your system for details.

Muting and unmuting

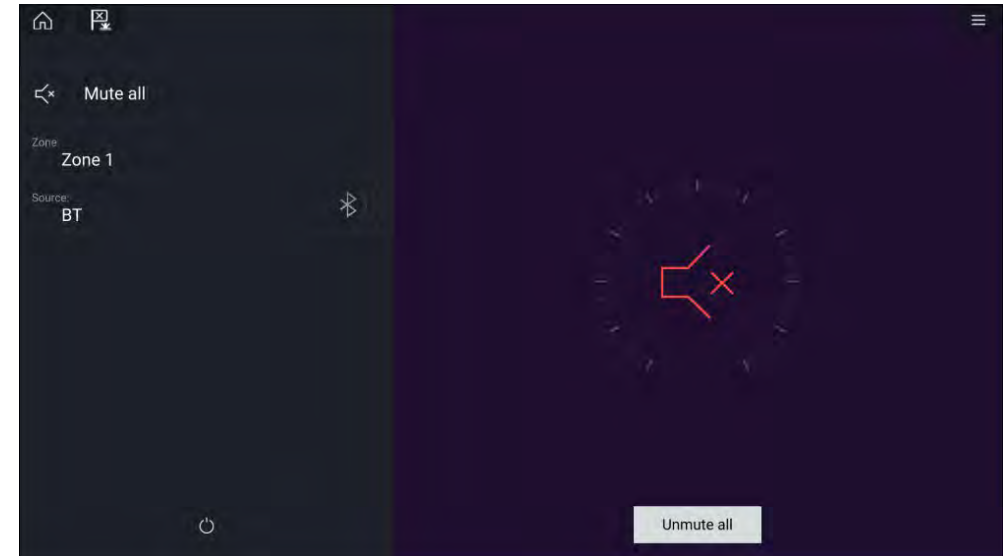

1. Select *[Mute All]*, to mute all audio.

When multiple entertainment systems are connected selecting [Mute all] will mute all zones on all connected entertainment systems.

2. To unmute the selected entertainment system, select the Mute icon in the center of the screen. If your entertainment system supports independent zone control then only the selected zone will be unmuted.

Selecting [Unmute all] will unmute all zones for all connected entertainment systems.

Browsing for tracks

You can browse USB and Bluetooth devices for tracks.

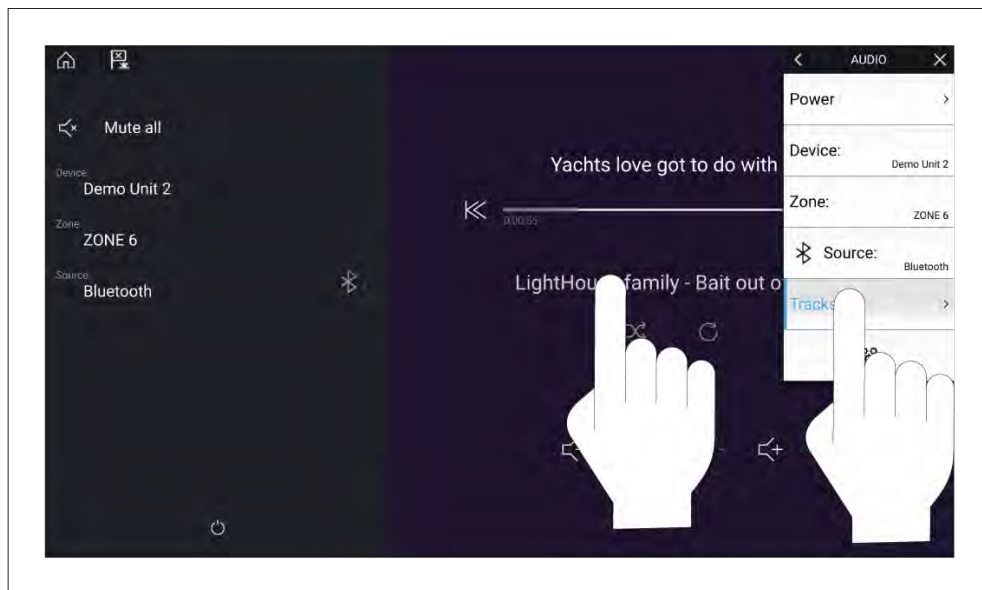

With the relevant USB or Bluetooth device selected as the audio source:

1. Select *[Tracks]* from the Menu.
The file browser is displayed.
2. Alternatively, you can select the current track's details to open the file browser.
3. Browse to the file you want to play.

Wait for the file list to finish loading before selecting a track.

4. Select the track you want to play.

Browsing for stations / channels

You can browse available Radio stations/channels.

With the relevant Radio device selected as the audio source:

1. Select *[Stations]* or *[Channels]* from the Menu.
The station or channel browser is displayed.
2. Browse to and select the station or channel you want to listen to.

Note: For SiriusXM, channel control is not available from an external audio head unit.

Saving presets

Up to 4 presets can be saved for each Radio audio source (i.e.: AM Radio, FM Radio, Weather, SiriusXM and Pandora).

1. Whilst listening to the station you want to save, press and hold the relevant Preset button for approximately 3 seconds.

Powering off entertainment systems

Connected entertainment systems can be powered off using the Audio app.

With the Audio app displayed and the entertainment system powered on:

1. Select the *[Power]* icon located on the bottom left of the screen.
If only 1 entertainment system is connected then the entertainment system will power off. If more than 1 entertainment system is connected then pop-over options are displayed allowing you to choose the entertainment system to turn off, or you can select *[Power down all]* to power off all connected systems.

Tip

Refer to the instructions provided with your entertainment system for details on naming your device. This aids device identification when multiple systems are connected.

31.4 Audio app menu options

The options available in the Audio app menu are dependent on the connected entertainments systems and audio source.

Menu item / Description	Options
<i>[Power]</i> Enables you to Power your Entertainment system on and off	<ul style="list-style-type: none"> • On • Off
<i>[Device]</i> When more than 1 entertainment system is connected you can change which system the audio app is controlling / displaying details for.	List of connected devices.
<i>[Zone]</i> When the entertainment system supports multiple zones you can change which zone the audio app is controlling / displaying details for.	List of zones..
<i>[Source]</i> Change the audio source for the entertainment system. If your entertainment system supports independent control of zones then only the source for the selected zone will change. Only supported audio source will be displayed.	<ul style="list-style-type: none"> • AM Radio • FM Radio • Weather • Sirius XM • Pandora • Auxiliary • USB • Bluetooth • Airplay • S/PDIF

Menu item / Description	Options
<i>[Tracks]</i> / <i>[Channels]</i> / <i>[Stations]</i> <ul style="list-style-type: none"> • The Tracks menu option is available for USB and Bluetooth audio sources. When selected the folder browser is displayed. • The Channels menu option is available for SiriusXM. <p>Note: Control is not available from SiriusXM device.</p> <ul style="list-style-type: none"> • The Stations menu option is available for Pandora. 	Folder browser or channel/station list.
<i>[Settings]</i> Displays the Settings menu	<ul style="list-style-type: none"> • Audio setting • Page settings

Audio app settings menu

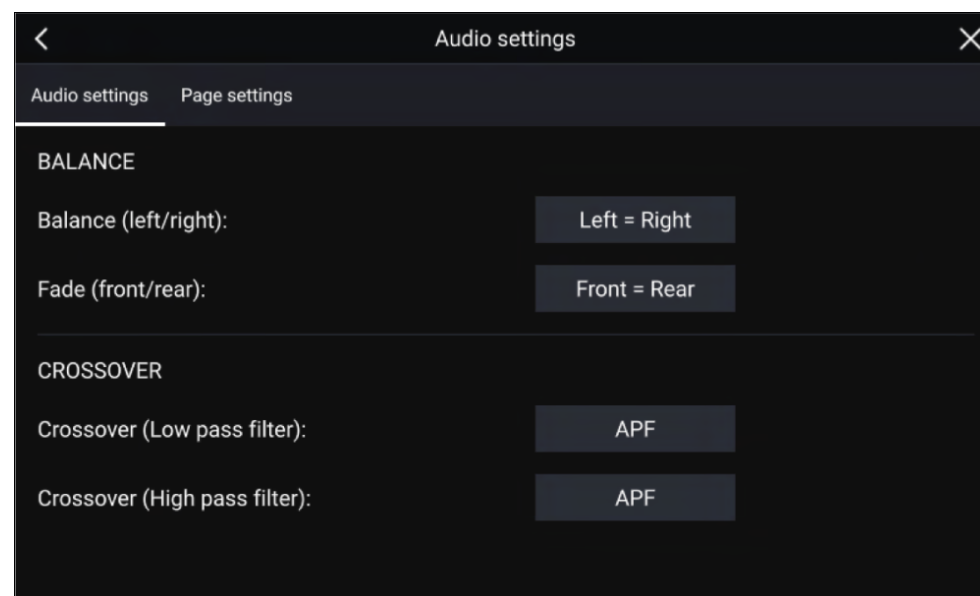

Audio settings tab

Menu item	Description	Options
[Balance]	Allows you to control the left / right speaker balance of your entertainment system speakers.	<ul style="list-style-type: none"> • L = Left speakers up to 100% • Left = Right (Balance centered) • R = Right speakers up to 100%
[Fade]	Allows you to control the front / back speaker fade of your entertainment system speakers. Note: Only available on Rockford Fosgate entertainment systems.	<ul style="list-style-type: none"> • F = Front speakers up to 100% • Front = Back (Fade centered) • R = Rear speakers up to 100%
[Crossover (Low pass filter):]	Allows you to select the crossover frequency. The Low Pass Filter (LPF) will block all audio frequencies above the threshold you specify. Selecting APF (All Pass Filter) will allow all frequencies.	<ul style="list-style-type: none"> • 60 Hz • 80 Hz • 120 Hz • APF
[Crossover (High pass filter):]	Allows you to select the crossover frequency. The High Pass Filter (HPF) will block all audio frequencies below the threshold you specify. Selecting APF (All Pass Filter) will allow all frequencies.	<ul style="list-style-type: none"> • 60 Hz • 80 Hz • 120 Hz • APF

Menu item	Description	Options
[Multi-zone volume control:]	Allows you to select independent audio zones that are controlled by multi-zone volume control. Note: Only available on Fusion audio devices with multi-zone control.	<ul style="list-style-type: none"> • Audio zones 1–12
[Reset:]	Performs a factory reset and power cycle of the SR200. Note: Only available on Sirius SR200 devices.	<ul style="list-style-type: none"> • Reset
[Diagnostics mode:]	Displays the SR200's diagnostic information. Note: Only available on Sirius SR200 devices.	<ul style="list-style-type: none"> • Display diagnostics

Page settings tab

Settings	Description
[Data Overlays]	Enables configuration of Data overlays
[Edit split ratio]	Enables you to customize the position of the partitions in splitscreen app pages.

Adjusting balance and fade controls

From the [Audio settings] menu: [Menu > Audio settings]

1. Select the [Balance] setting field or the [Fade] setting field.
The Adjustment slider control is displayed.

- Place your finger on the White marker and then slide it left or right to adjust the setting the required value, alternatively use a *[Rotary controller]* to adjust the setting the required value.

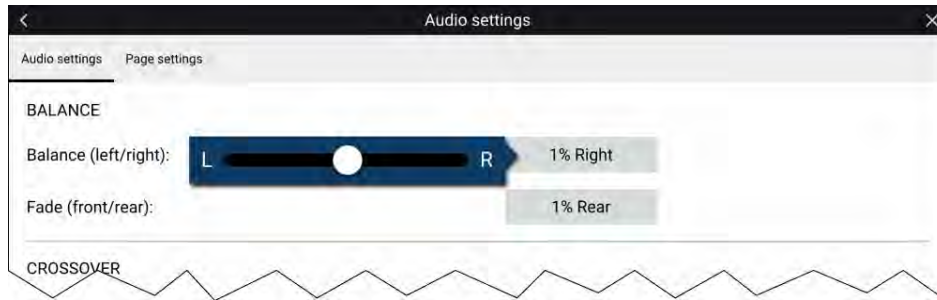

Note:

The fader control will only be displayed for systems that support fading..

Adjusting multi-zone controls

When supported by the entertainment system the audio app can be configured to control the volume of multiple zones simultaneously.

From the *[Audio settings]* menu: *[Menu > Audio settings]*.

- Select the zones you want to include in Multi-zone volume control.

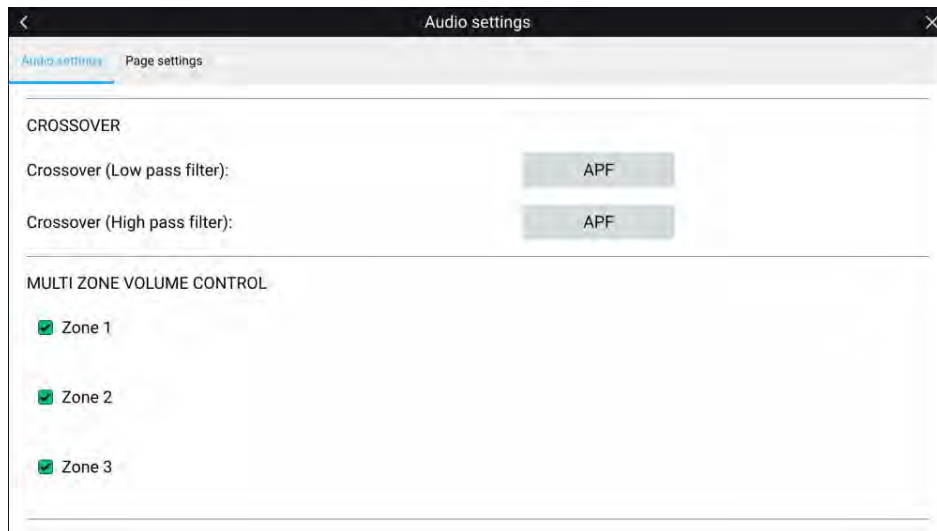

- Enable and disable multi-zone volume control by selecting the text as shown below.

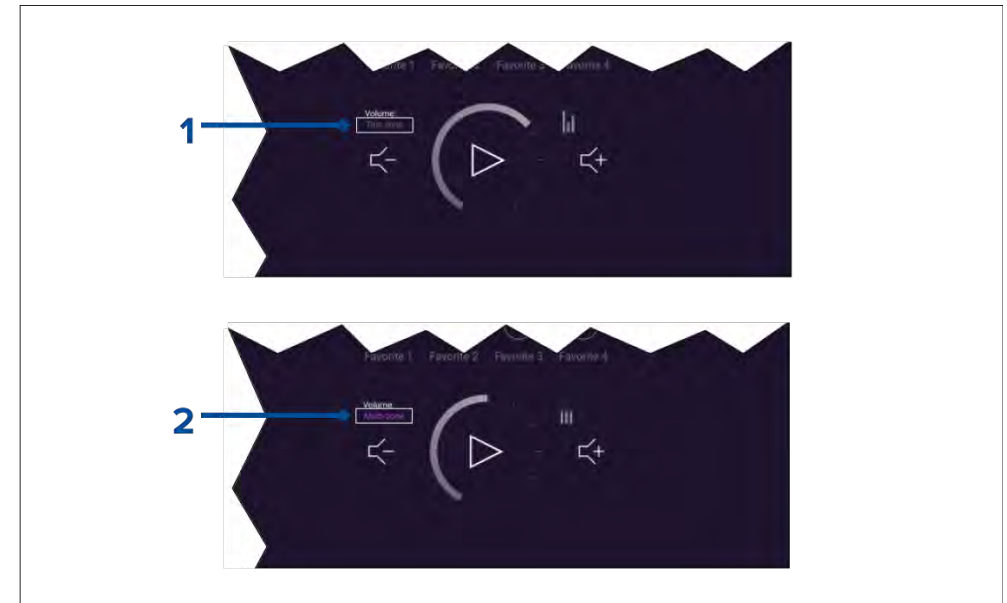

- To enable multi-zone control select the text '*[This zone]*'.
- To disable multi-zone control select the text '*[Multi-zone]*'.

SR200 diagnostics mode

The SR200 diagnostic mode can be accessed from the audio settings menu from the master MFD on the network. The diagnostics mode should be referred to when liaising with Sirius product support.

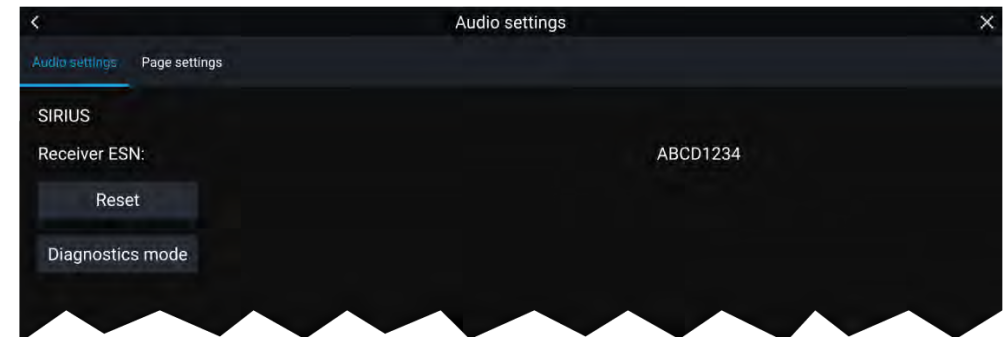

1. Reset — Performs a factory reset and power cycle of the SR200.
2. Diagnostics mode — Displays the SR200's diagnostic information.

CHAPTER 32: PDF VIEWER APP

CHAPTER CONTENTS

- [32.1 PDF Viewer app overview — page 487](#)
- [32.2 Opening PDF files — page 487](#)
- [32.3 PDF Viewer controls — page 488](#)
- [32.4 Searching a PDF — page 488](#)

32.1 PDF Viewer app overview

The PDF Viewer app can be used to browse and open PDF files located on your external storage device(s).

A typical use for the PDF viewer is to display Raymarine product handbooks that you have downloaded from the Raymarine website (www.raymarine.com/manuals). PDF files must first be copied to a MicroSD card using an external device (such as a PC or tablet). You can then insert the MicroSD card into your MFD's card slot, and access the PDF file(s) via the PDF Viewer app.

Note:

- Secured PDF documents (encrypted with certificate or password) are not supported.



Warning: Distraction disclaimer

- The MFD/Chartplotter includes various entertainment apps. Whilst navigating do NOT let these apps distract your attention from safe navigation.
- Any distraction while navigating causes a lapse in concentration which increases the risk of collision. To avoid hazards you must give navigation your full attention at all times.

32.2 Opening PDF files

When opened, the PDF Viewer app allows you to browse PDF files available on your external storage device(s).

Select *[Browse]* to open a PDF file.

Recently-viewed files are displayed on the right-hand side of the initial app start screen, for quick access. These files can be opened, pinned to the top of the list, or removed from the list.

To access these options, long-hold touch on a filename to display the context menu.

Note:

- Recent files cannot be opened if the files are deleted or the external storage device is removed.
- A maximum of 15 of the most recent files can be shown in the pinned and unpinned recent files list.

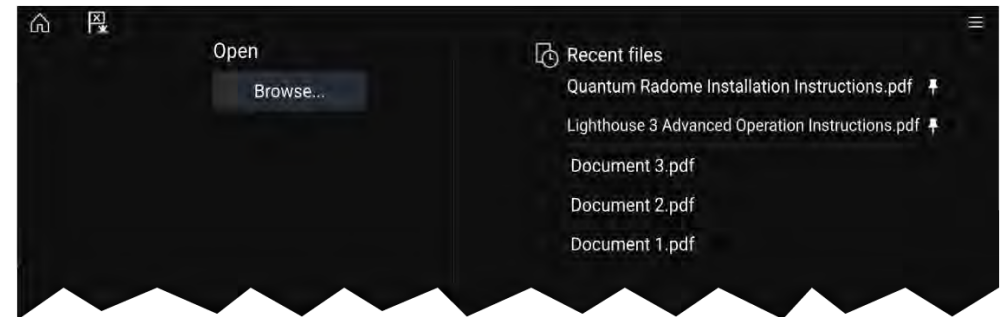

32.3 PDF Viewer controls

When a PDF file is displayed in the PDF Viewer app, the following options are available.

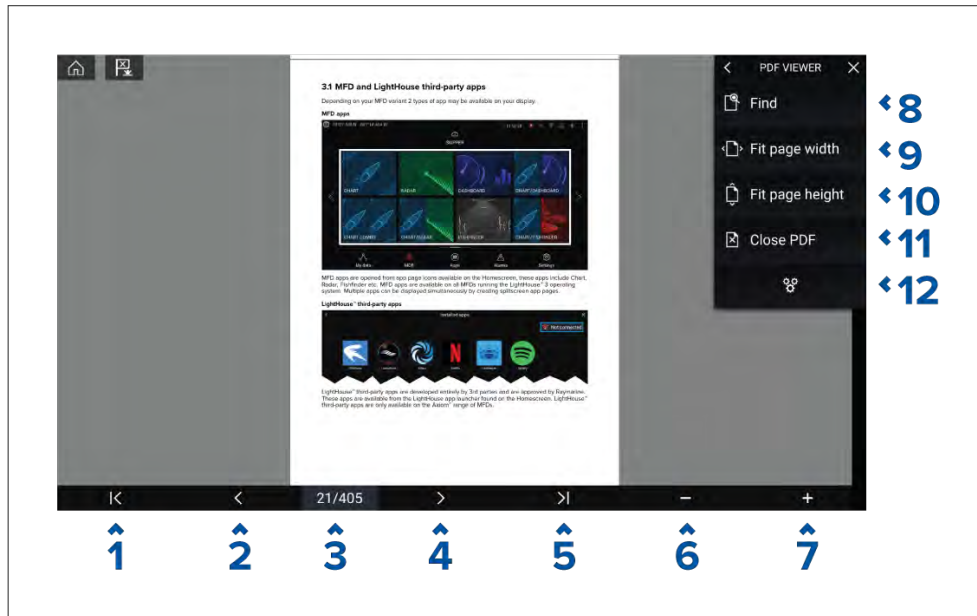

1. **First page** — Select to display the first page of the PDF document.
2. **Page back** — Select to display the previous page.
3. **Pages** — Indicates current page and total number of pages. You can also tap this element and enter a specific page number.
4. **Page forward** — Select to display the next page.
5. **Last page** — Select to display the last page of the PDF document.
6. **Zoom out** — Select to zoom out, in 10% increments.
7. **Zoom in** — Select to zoom in, in 10% increments.
8. **Find** — Select to display the onscreen keyboard and enter a search word or phrase.
9. **Fit page width** — Zoom the document display to fit the width of the PDF page.
10. **Fit page height** — Zoom the document display to fit the height of the PDF page.

11. **Close PDF** — Closes the PDF and displays the initial PDF Viewer app start screen.
12. **Settings** — Displays the Settings menu, which allows you to add data overlays to the PDF Viewer app.

32.4 Searching a PDF

You can search a PDF document for a word or phrase using the Find function.

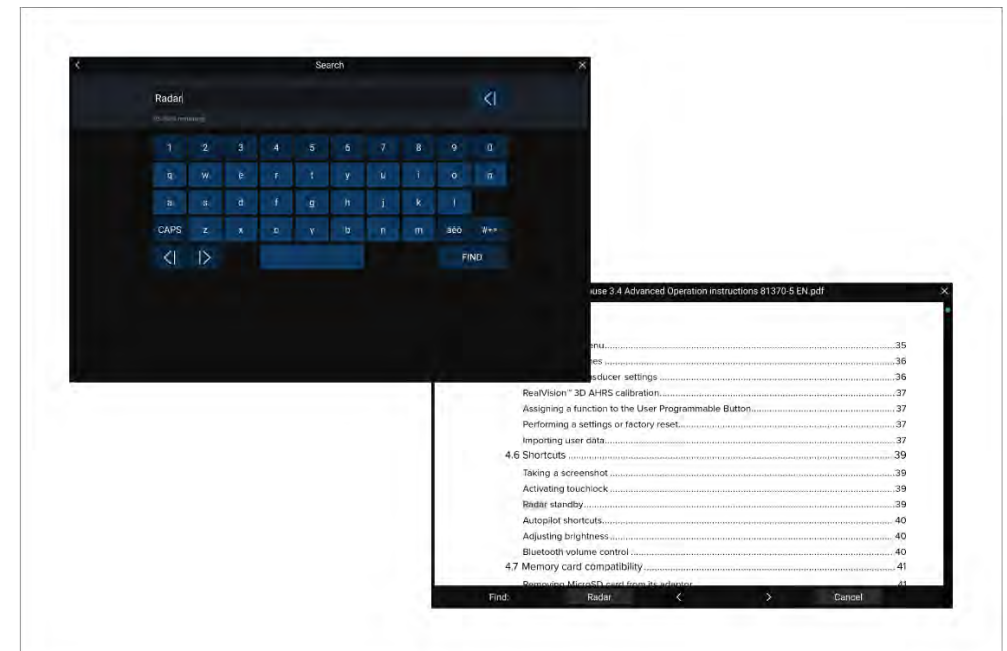

With the PDF displayed in the viewer:

1. Select *[Find]*.
2. Enter the word or search term.
3. Select *[FIND]*.

The document will scroll to the first occurrence of the searched term, which will be highlighted. Use the *[Right arrow]* and *[Left arrow]* controls to cycle to the previous or next occurrence of the search term. You can also search for another term by selecting *[Find]* and entering a new term, or you can cancel the find function by selecting *[Cancel]*.

CHAPTER 33: MOBILE APP SUPPORT

CHAPTER CONTENTS

- 33.1 Raymarine mobile apps — page 490
- 33.2 Connecting an Android device to the display — page 490
- 33.3 Connecting an iOS device to the display — page 491
- 33.4 Raymarine app — page 491
- 33.5 Fishidy sync — page 495
- 33.6 Navionics plotter sync — page 496
- 33.7 Controlling your display using RayControl — page 496
- 33.8 Controlling your display using RayRemote — page 497
- 33.9 Viewing your MFD screen using RayView — page 497

33.1 Raymarine mobile apps

Please check the relevant app store for Raymarine mobile apps.

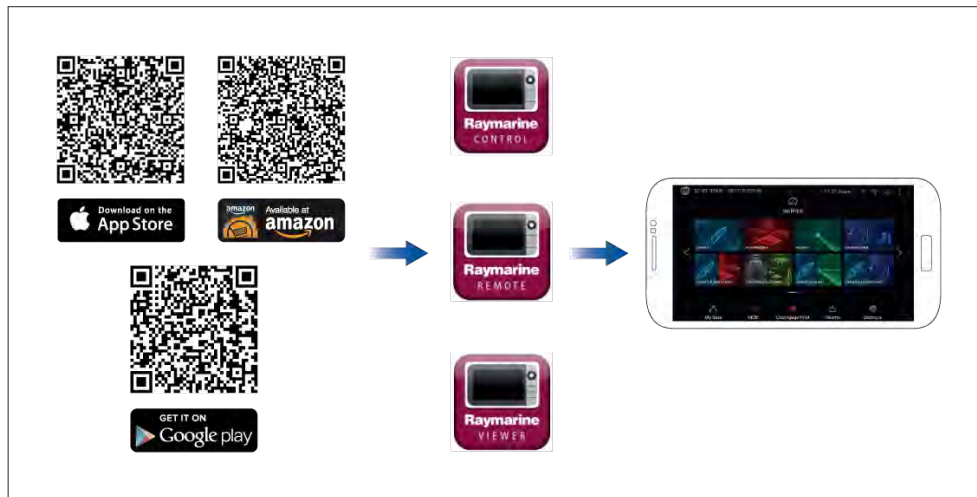

Note: When updating your MFD software ensure that you check for updates to your mobile apps.

33.2 Connecting an Android device to the display

Android devices can be connected to the display's Wi-Fi connection.

Open your Android device's Wi-Fi settings from the top drop down menu or via the *[Settings]* icon.

Example Android Wi-Fi connection

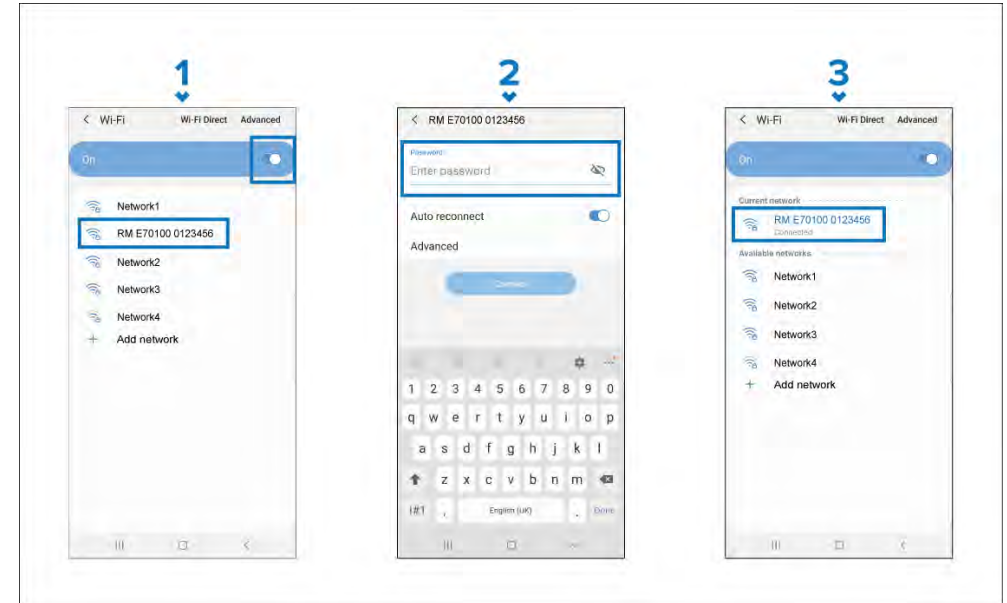

Note:

Depending on device type, manufacturer and version of the Android operating system in use, screens and options may be different than in the example above.

1. Enable Wi-Fi by setting the toggle to on (blue) and select your MFD from the available networks.
2. Enter your MFD's Wi-Fi passphrase and select *[Connect]*.

Make sure the password you enter is case sensitive.

3. Once your Android device is connected to your MFD's Wi-Fi network, it will display "Connected" under the MFD's device name.

For troubleshooting advice, refer to the Wi-Fi troubleshooting information in the *Troubleshooting* chapter.

33.3 Connecting an iOS device to the display

iOS devices can be connected to the display's Wi-Fi connection.

Open your iOS device's Wi-Fi settings from the top drop down menu or via [Settings].

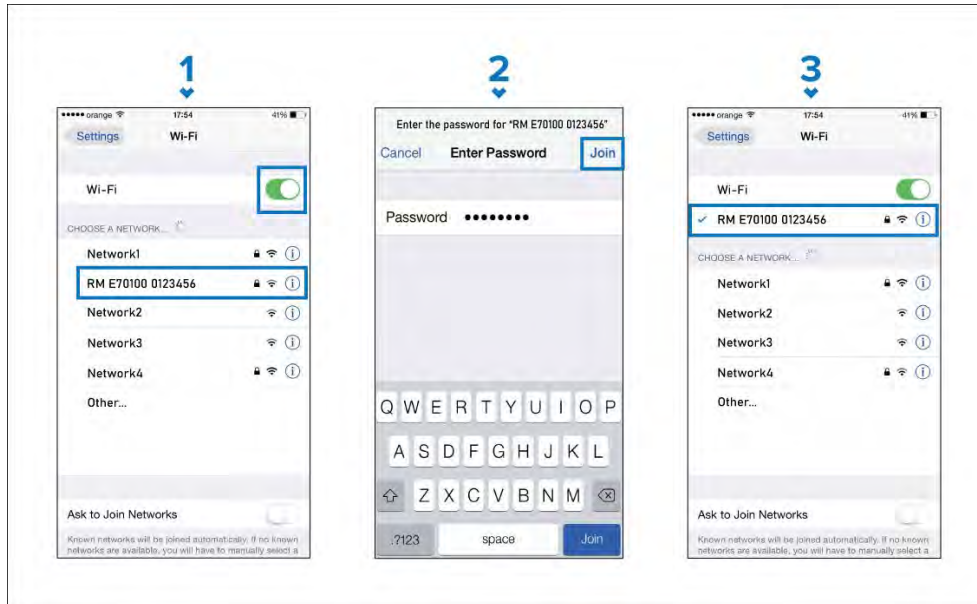

Note:

Depending on device type, and iOS version in use, screens and options may be different than in the example above.

1. Enable Wi-Fi by setting the toggle to on (green) and select your MFD from the available networks.
2. Enter your MFD's Wi-Fi passphrase and select join.

Make sure the password you enter is case sensitive.

3. When your iOS device is connected to your MFD's Wi-Fi it will display a tick next to the MFD's name.

For troubleshooting advice refer to the Wi-Fi troubleshooting information on the Troubleshooting chapter [p.514 – Troubleshooting](#)

[Mobile app support](#)

33.4 Raymarine app

You can use the Raymarine app to purchase and download LightHouse™ Charts from the Chart Store.

Important: Download packages containing Charts for larger regions (such as North America, Northern Europe, and Australia/NZ) and also those including satellite photos, consist of very large files, which can take a long time (possibly several hours) to download via a mobile device and the Raymarine app. When purchasing these larger download packages, it is recommended that you download the Charts from the Chart Store **via a web browser** on a laptop or PC. For more information on this procedure, refer to: [p.205 – Downloading Charts from the Chart Store](#)

If you wish to use the Raymarine app to download LightHouse charts, use the following procedure:

1. Log in to the Raymarine app with an existing Raymarine account, or create a new account using the app.
2. Purchase LightHouse™ Charts, via the Chart Store accessible from the app.
3. Define the regions and types of cartographic data you want the chart to contain.
4. Connect your mobile device's Wi-Fi to your Raymarine multifunction display (MFD). For information on connecting your mobile device, refer to:
 - Android — [p.490 – Connecting an Android device to the display](#)
 - iOS — [p.491 – Connecting an iOS device to the display](#)
5. Download the charts to a MicroSD card inserted in your Raymarine multifunction display (MFD). Alternatively, if you're using an Axiom® or Axiom® 2 MFD, you can download the charts to the MFD's internal memory storage

How to obtain the Raymarine app

The Raymarine app is available for Android and Apple iOS devices, and can be installed on your mobile device from the relevant app store.

To obtain the Raymarine app from the relevant app store for your device, point your mobile device's camera at one of the following QR codes:

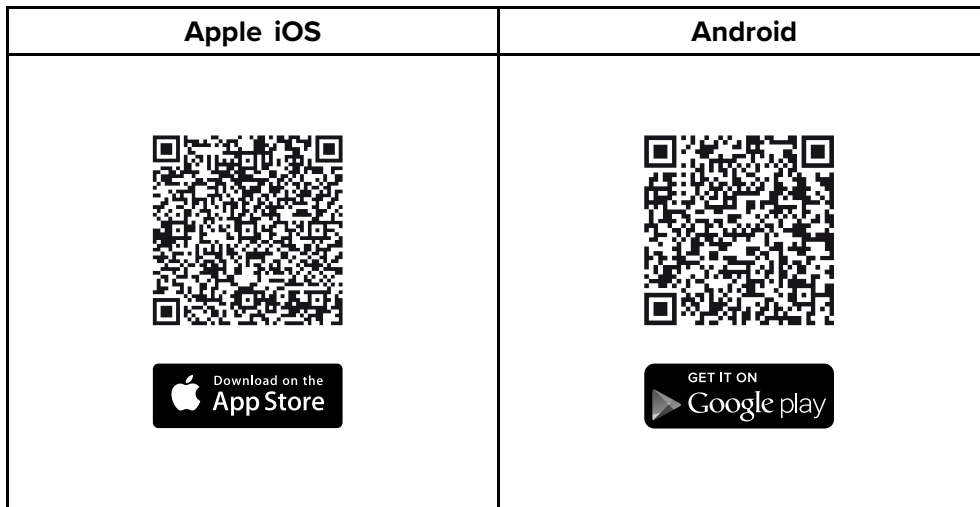

Once you've installed the app, you will need to create a Raymarine account to log in to the app.

LightHouse charts

LightHouse™ charts is the brand name for Raymarine's electronic navigation charts. LightHouse™ charts can include a Premium subscription, which adds new and enhanced features on a regular basis.

Note:

Legacy LightHouse™ Vector, Raster and NC2 charts have now been discontinued and can no longer be downloaded or updated.

New LightHouse™ charts come with a free 1 year subscription to LightHouse™ Premium. The Premium subscription unlocks data-rich points of interest (POI), high-resolution satellite aerial overlays and regular chart updates. After the free subscription period ends, the Premium features can be continued for an annual fee.

LightHouse™ charts can be purchased directly from the LightHouse™ Chart Store. Alternatively, they can be purchased from Raymarine dealers, as either a pre-loaded chart card or a blank chart card that includes a voucher that can be redeemed from the Chart Store.

To find out more about available regions and the latest features, visit the LightHouse™ Chart Store: <https://chartstore.raymarine.com/lighthouse-charts>

LightHouse Chart Store

LightHouse™ charts can be purchased from the LightHouse™ Chart Store, which can be accessed from a personal computer (PC) or from a mobile device via the Raymarine app.

You must have a Chart Store account and be logged in to the account before you can purchase charts in the Chart Store. This account can be created during the checkout process if required.

Important: Download packages containing Charts for larger regions (such as North America, Northern Europe, and Australia/NZ) and also those including satellite photos, consist of very large files, which can take a long time (possibly several hours) to download via a mobile device and the Raymarine app. When purchasing these larger download packages, it is recommended that you download the Charts from the Chart Store **via a web browser** on a laptop or PC. For more information on this procedure, refer to: [p.205 — Downloading Charts from the Chart Store](#)

The Chart Store can be accessed using the following link:
<https://chartstore.raymarine.com/lighthouse-charts>

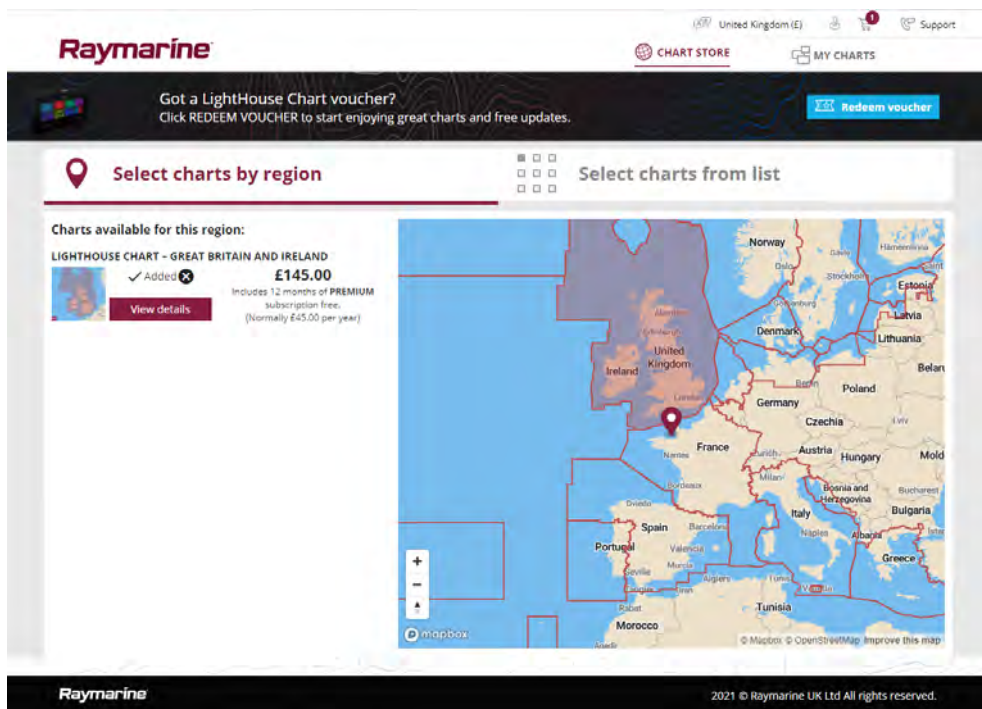

Downloading charts using the Raymarine app

Purchased LightHouse™ charts can be downloaded to the MFD via a mobile device, using the Raymarine app and Wi-Fi to transfer the charts to a MicroSD (µSD) memory card inserted into your MFD, or to the internal storage of an Axiom® or Axiom® 2 MFD.

Important: Download packages containing Charts for larger regions (such as North America, Northern Europe, and Australia/NZ) and also those including satellite photos, consist of very large files, which can take a long time (possibly several hours) to download via a mobile device and the Raymarine app. When purchasing these larger download packages, it is recommended that you download the Charts from the Chart Store **via a web browser** on a laptop or PC. For more information on this procedure, refer to: [p.205 — Downloading Charts from the Chart Store](#)

When downloading charts via a mobile device and the Raymarine app, the following pre-requisites should be observed:

[Mobile app support](#)

- If using mobile data, ensure you have sufficient data allowance remaining to prevent being charged.
- Ensure you have sufficient free space on your mobile device's internal storage for the charts to be downloaded to.
- Ensure that the memory card you want to use is formatted in the exFAT file system format (Chart cards purchased from the Raymarine chart store will arrive in this format).
- Ensure that the memory card has been inserted into the display's card reader prior to commencing the process (this will create the necessary Lighthouse_ID file in the card's root directory).
- A file named 'Lighthouse_charts' must be created in the memory card's root directory (Chart cards purchased from the Raymarine chart store will already include this file).
- It is recommended that there are no other files on the memory card prior to downloading charts to it.
- Ensure *[Allow devices to connect]* is enabled in your display settings:
 - Element™ displays: *[Homescreen > Settings > Wi-Fi]*.
 - Axiom® displays: *[Homescreen > Settings > This display > Wi-Fi SHARING]*.
- Connect your mobile device's Wi-Fi to your MFD. For information on connecting your mobile device, refer to:
 - Android — [p.490 — Connecting an Android device to the display](#)
 - iOS — [p.491 — Connecting an iOS device to the display](#)

Note:

- Once a storage location (memory card or internal memory) has been chosen for your charts you cannot change it. Charts cannot subsequently be saved to a different card.
- Charts cannot be downloaded to the internal storage of Element™ displays.

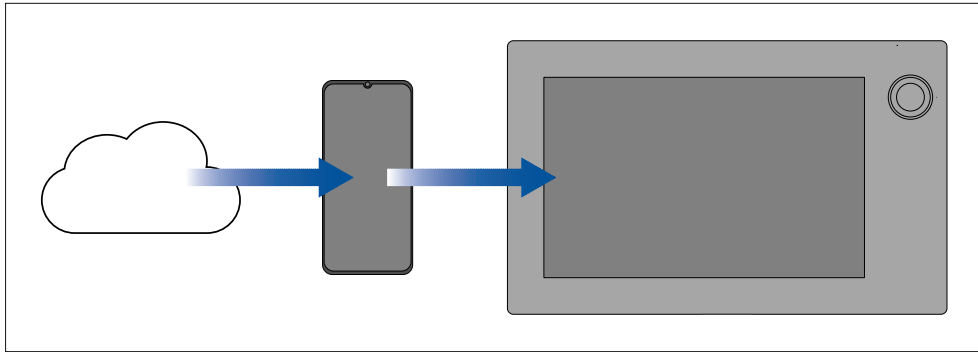

1. Install and open the Raymarine app from the relevant app store, using the relevant QR code provided below.
2. Create an account or Log in to the Raymarine app.
3. If requested select *[ALLOW ONLY WHILE USING THE APP]*.
4. Go to the *[MY CHARTS]* area.
5. Select the chart region you want to download.
6. If you have more than one region on the same continent in MY CHARTS, to minimize download file size, you can group up to 3 regions together.
7. If updates are available click *[Get latest data]*.
8. If you have a valid Premium subscription you can add *[Streets & Points of Interest]* and *[Aerial photos]* by clicking *[Add now]*, next to the items you want to include.





When adding [Streets & Points of Interest] and [Aerial photos] you can create up to 5 area boxes for each feature per purchased region. Follow the onscreen instructions to define each area of coverage.

9. Select *[Download]* and then follow the onscreen instructions to download your charts to your MFD.

How to obtain the Raymarine app

The Raymarine app is available for Android and Apple iOS devices, and can be installed on your mobile device from the relevant app store.

To obtain the Raymarine app from the relevant app store for your device, point your mobile device's camera at one of the following QR codes:

Apple iOS	Android
 	 

Once you've installed the app, you will need to create a Raymarine account to log in to the app.

Account settings

You can edit your Raymarine account details using the *[Account]* menu.

You can edit the account's:

- Name
- Email address
- Password
- Region
- News and offers notification settings

33.5 Fishidy sync

You can synchronize Fishidy Spots and Waypoints between the Fishidy app and your MFD's Chart app.

Note:

Fishidy sync requires:

- Fishidy software version 6.1.0 or later.
- LightHouse version 3.11 or later.
- LightHouse version 4.0 or later.

Note:

Fishidy is currently available in:

- North America

Additional regions will become available in future Fishidy updates.



Enable sync

After connecting your mobile device to your MFD's Wi-Fi, you can begin syncing waypoints and Fishidy spots with the Fishidy app.

1. From the Fishidy app select *[More]*.
2. Select *[Raymarine Sync]*.
3. Select *[Enable Sync]* to begin synchronization between your Fishidy app and MFD.

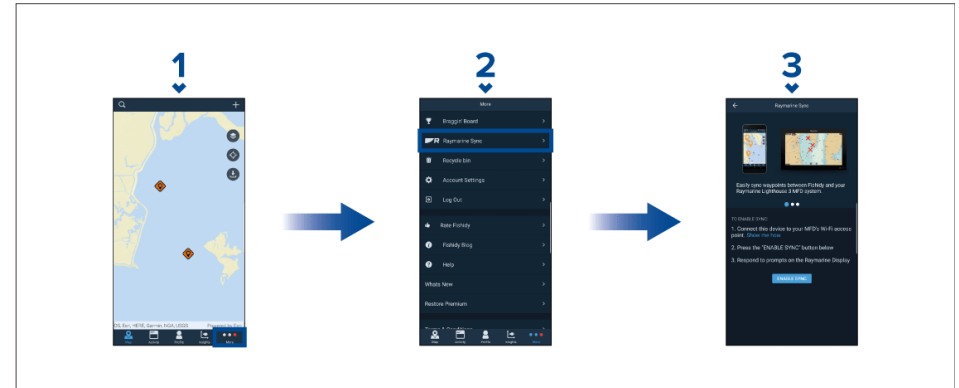

4. When prompted by your MFD, select *[Yes]* to confirm sync.

If you select [No], sync will be cancelled and will need to be restarted.

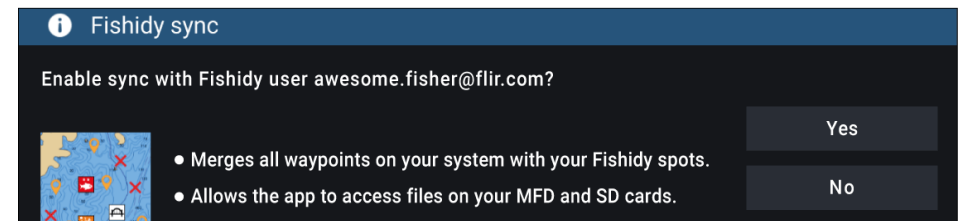

Once enabled, data will automatically sync in real-time across both devices via Wi-Fi.

Note:

- Fishidy Spots and Waypoints will be shared and can be interacted with from both devices.
- Your private waypoints remain private, whether viewing on Fishidy or your Raymarine MFD system.
- If you edit a Fishidy Spot or Waypoint on either device when sync is disabled (e.g. editing the name), re-enabling sync might place the item in the Fishidy *[Recycle Bin]*. In this scenario, the data can be restored from the recycling bin in the Fishidy app.
- Attempting to sync a new Fishidy account to your MFD while it is already synced with another account will prompt you to end sync with the first account. Ending sync with the first account and syncing the second account replaces any existing Fishidy Spots and Waypoints.

Disable sync

You can disable Fishidy sync from the Fishidy app or your MFD.

1. *[Fishidy app]*
 - i. Access the *[Raymarine Sync]* menu and select *[Disable Sync]*.
 - ii. *[More > Raymarine Sync > Disable Sync]*
2. *[MFD]*
 - i. Access the *[My Data]* page, select *[Mobile sync]* and select *[Disable sync]*.
 - ii. *[Homescreen > My Data > Mobile sync > Disable sync]*

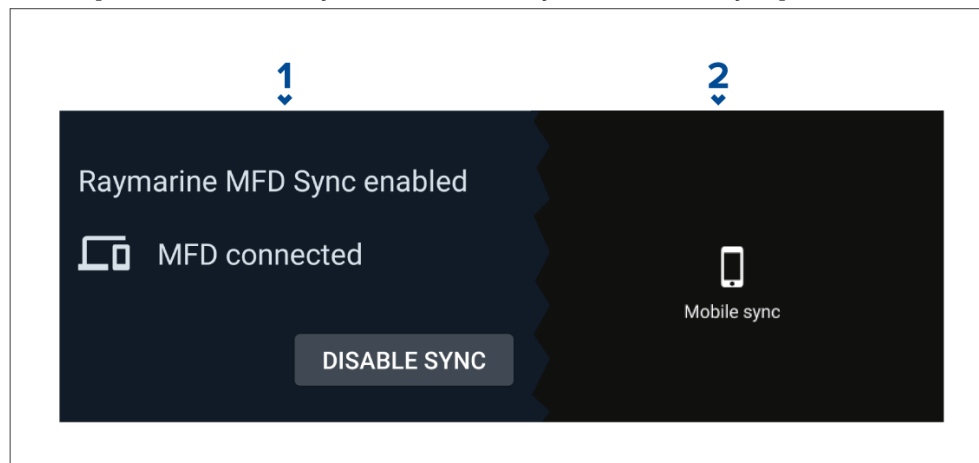

33.6 Navionics plotter sync

You can use the Navionics boating mobile app to:

- transfer waypoints and routes between your MFD and mobile device.
- update, activate and renew your Navionics cartography

33.7 Controlling your display using RayControl

The RayControl app allows you to remotely view and control your display from your mobile device.

1. Download and install RayControl from your app store.
2. Ensure your mobile device is connected to your display's Wi-Fi.
3. Open the RayControl app.
4. Control your display using your mobile device's touchscreen in the same way you would interact with the display's touchscreen.
5. You can also use a representation of a display's physical buttons by sliding the controls sidebar out from the right of the screen or on smaller devices selecting *[Remote Control]*.

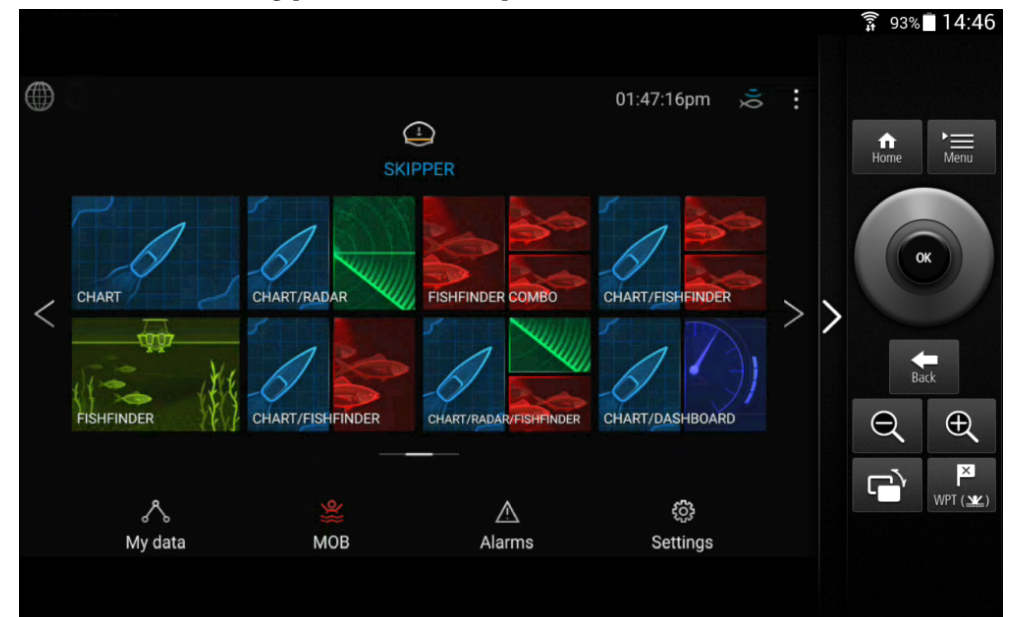

33.8 Controlling your display using RayRemote

The RayRemote app allows you to remotely control your display from your mobile device.

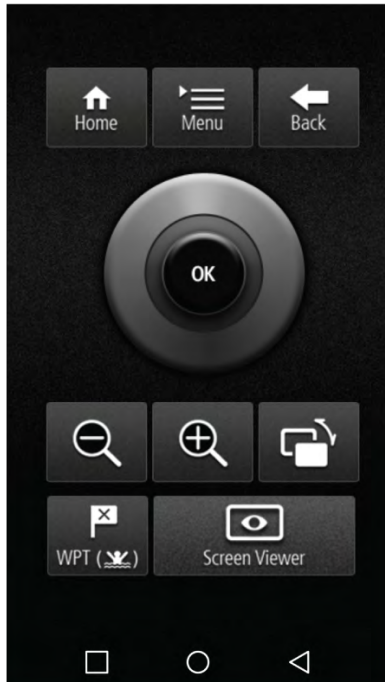

1. Download and install RayRemote from your app store.
2. Ensure your mobile device is connected to your display's Wi-Fi.
3. Open the RayRemote app.
4. Control your display on your mobile device using the on-screen equivalents of the physical buttons.

33.9 Viewing your MFD screen using RayView

The RayView app allows you to remotely view your MFD from your mobile device.

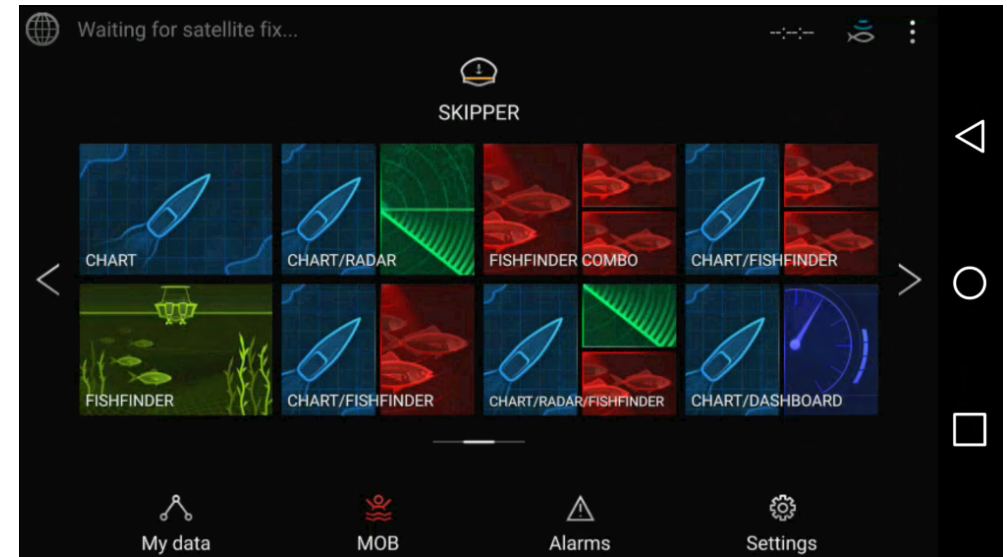

1. Download and install RayView from your app store.
2. Ensure your mobile device is connected to your MFD's Wi-Fi.
3. Open the RayView app.
4. Your mobile device's screen will now mirror your MFD's screen.

CHAPTER 34: PARTNER INTEGRATION AND THIRD-PARTY APPS

CHAPTER CONTENTS

- [34.1 Partner integration — page 499](#)
- [34.2 LightHouse third-party apps — page 499](#)
- [34.3 App launcher — page 499](#)
- [34.4 Interface shortcuts on the homescreen — page 501](#)
- [34.5 Bluetooth speaker set up — page 501](#)

34.1 Partner integration

Raymarine allows third-party hardware suppliers to integrate their hardware with Raymarine Axiom® and Axiom® 2 displays.

Integration allows Interface shortcuts to be available on the display which provide access to HTML-based user interfaces for integration partner's hardware.

The hardware must be connected to the display using an ethernet connection.

Interface shortcuts can be accessed from the App launcher and can also be included in app pages on the homescreen.

Details of current integration partners is available on the Raymarine website: <http://www.raymarine.com/multifunction-displays/lighthouse3/lighthouse-apps/>

Raymarine also partners with third-party hardware suppliers that use Android APK apps to control their hardware. These APKs are approved and installed the same way as LightHouse third-party apps.

Note:

- For partners who integrated after the release of LightHouse™ 3 version 3.16, the interface shortcuts are only displayed when the display detects partner hardware.
- For partners who integrated after the release of LightHouse™ 4, the interface shortcuts are only displayed when the display detects partner hardware.
- Raymarine does not warrant or provide support for third-party user interfaces or related third-party hardware. Please refer to the relevant partner for assistance and troubleshooting.

34.2 LightHouse third-party apps

LightHouse™ third-party apps are Android APK apps, developed by third parties and approved for use on Raymarine displays running the LightHouse™ 3 or LightHouse™ 4 operating system.

Android APK apps must be digitally signed by Raymarine. Signed APKs can then be bundled with LightHouse™ operating system updates and / or downloaded from the Raymarine website and installed on the displays.

APK apps can be accessed from the App launcher.

[Partner Integration and third-party apps](#)

A list of current approved APKs can be found on the Raymarine website: Details of current integration partners is available on the Raymarine website: <http://www.raymarine.com/multifunction-displays/lighthouse3/lighthouse-apps/>

Note:

- APKs from other sources such as the Google Play store that have not been signed by Raymarine cannot be installed on Raymarine displays.
- Raymarine does not warrant or provide support for third-party apps or any related third-party hardware. Please refer to the relevant third party app developer for assistance and troubleshooting.

For a list of compatible app versions for Axiom® and Axiom® 2 displays refer to: [p.553 – Android apk compatibility](#)

34.3 App launcher

The app launcher provides access to LightHouse™ third-party apps and Interface shortcuts for third-party partner hardware.

Select the *[Apps]* icon located at the bottom of the Homescreen to open the App launcher.

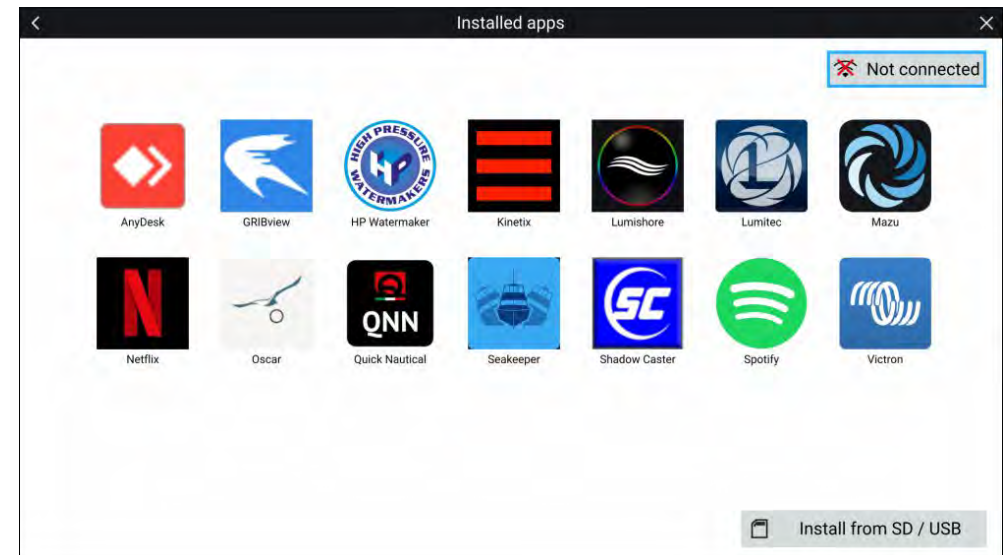

Selecting an icon will launch the app.

Some apps require an internet connection. You can connect your MFD to the internet by selecting the Wi-Fi connection icon located on the top right of the screen. Refer to: [p.84 — Internet connection](#)

APK apps downloaded from the Raymarine website can be installed by selecting *[Install from SD / USB]*. Refer to: [p.500 — Installing Lighthouse third-party apps](#)

To listen to audio, a Bluetooth speaker must be connected to the MFD. Refer to: [p.501 — Bluetooth speaker set up](#)

Apps may run in the background, enabling you to use your MFD as usual whilst, for instance, listening to music.

MFD alarms will be displayed and sounded as normal whilst using apps or partner interfaces. When paired with a Bluetooth speaker, alarms will also be sounded through the speaker.

Bluetooth speaker volume can be controlled from the Shortcuts page or from the Status bar area on the Homescreen.

Note:

If you use a wireless connection to a Quantum Radar, the Radar should be put in Standby before connecting your MFD to the internet.



Warning: Distraction disclaimer

- The MFD/Chartplotter includes various entertainment apps. Whilst navigating do NOT let these apps distract your attention from safe navigation.
- Any distraction while navigating causes a lapse in concentration which increases the risk of collision. To avoid hazards you must give navigation your full attention at all times.

Installing Lighthouse third-party apps

Additional Lighthouse third-party apps can be installed on your MFD via an SD card or USB.

To install Lighthouse third-party apps:

1. Copy the downloaded apk to your MicroSD card or USB device.
2. Insert SD card or USB device into your MFD or external card reader.

3. From the *[App Launcher]* page, select *[Install from SD / USB]*.

4. Browse to and select the apk file to install the app.

5. The app will be located on the *[App Launcher]* page.

You can uninstall Lighthouse third-party apps from your MFD by long pressing them and selecting *[uninstall]*.

Removing an apk app

Android apk apps can be removed (uninstalled) from your MFD by follow the steps below.

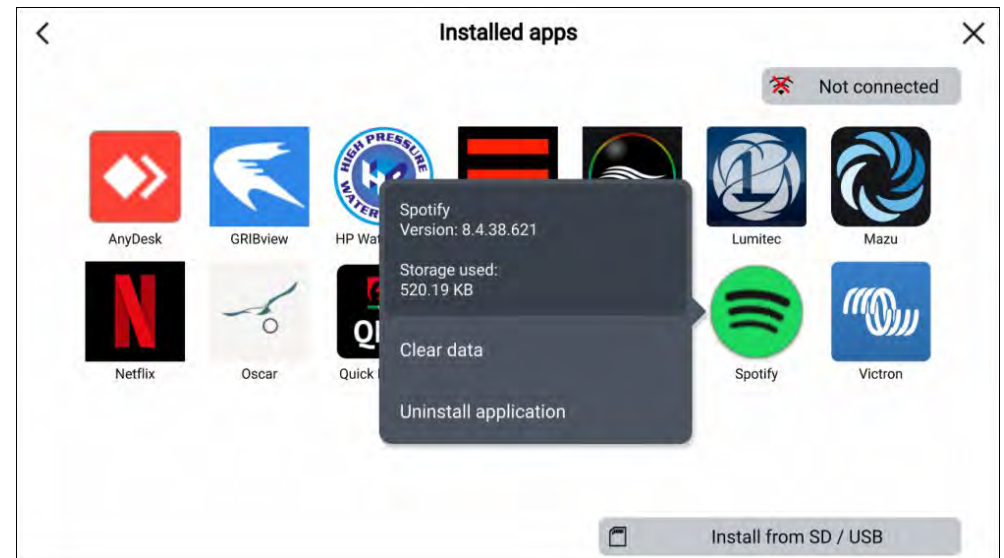

From the homescreen:

1. Select *[Apps]* to open the App launcher.
2. Press and hold on the android apk app to open the pop-over menu.

Partner hardware interface shortcuts cannot be removed this way.

3. Select *[Uninstall application]*.
4. Select *[Yes]* on the notification.

The app will be removed from the MFD.

Note:

Apps that do not have the *[Uninstall application]* option cannot be removed.

34.4 Interface shortcuts on the homescreen

When the MFD detects integration partner hardware, Interface shortcuts can be added to the homescreen.

Example

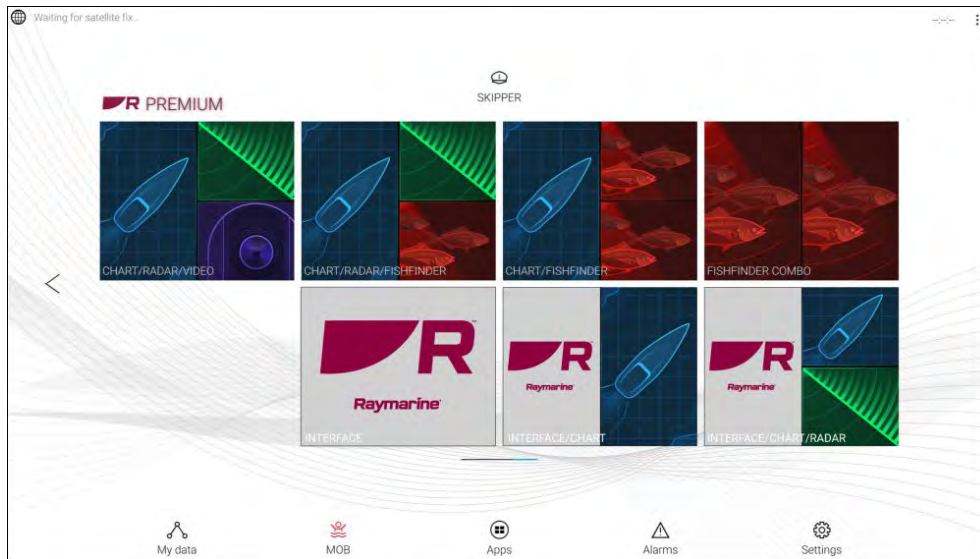

The Interface shortcuts can be added as either Fullscreen app pages or as part of portrait splitscreen app pages.

The method for creating the app page is the same as for creating an MFD app page. Refer to: [p.95 — Creating an app page](#)

If the associated hardware is removed or not detected, the app page icons will remain on the homescreen but you will not be able to access the hardware's user interface.

34.5 Bluetooth speaker set up

Enabling and disabling Bluetooth



1. Select the Status bar area located in the top right of the screen.
2. Select *[Bluetooth Settings]*.
3. Select the Toggle switch on the right of the Bluetooth settings page to enable Bluetooth.

Alternatively the Bluetooth settings page can be accessed from the This display settings tab: *[Homescreen > Settings > This display > Bluetooth > Bluetooth settings]*.

Bluetooth Settings

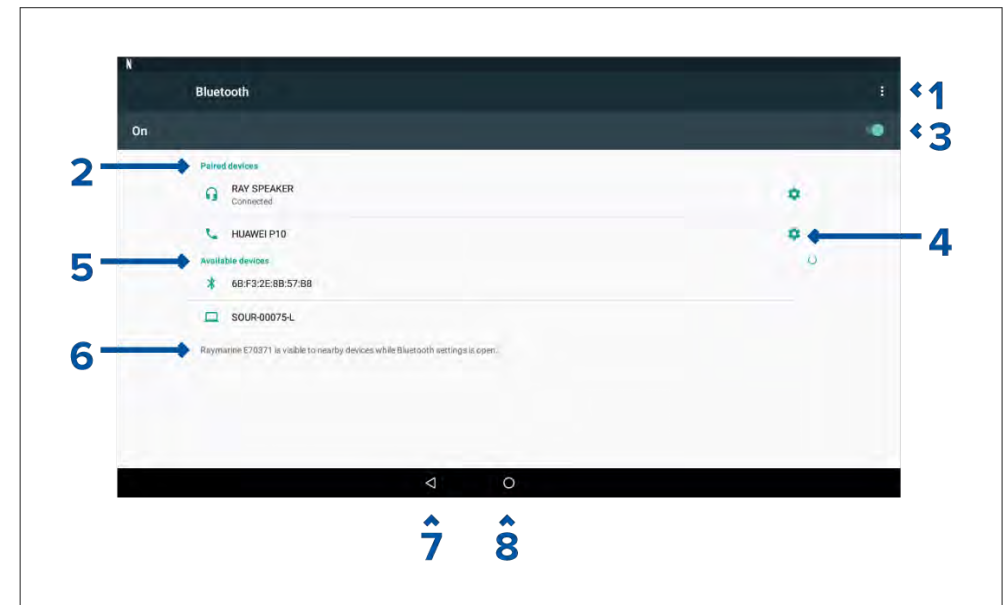

1. Bluetooth options — Provides the following options:

- Refresh — Selecting refreshes the list of available devices.
 - Rename this device — Allows you to rename the Bluetooth name your MFD uses.
 - Show file received — Not used as your MFD cannot receive files over Bluetooth.
2. Paired devices — List of devices paired with your ~MFD.
 3. Enable/Disable Bluetooth.
 4. Paired device settings — Allows you to rename the paired device or forget the device.
 5. Available devices — List of available Bluetooth devices.
 6. MFD Bluetooth name.
 7. Back button.
 8. Home button.

Pairing a Bluetooth speaker

Before attempting to pair with a Bluetooth speaker, ensure that the speaker is switched on and discoverable.

With your MFD's Bluetooth function enabled:

1. From the Bluetooth settings page, select the relevant device from the *[Available devices]* list.
2. If requested, confirm the Bluetooth pairing code.

If pairing is successful, the speaker will appear in the *[Paired devices]* list and display the *[Connected]* message.

Bluetooth volume control

When your MFD is connected to a Bluetooth speaker, controls will be available to adjust speaker volume.

Homescreen



From the Homescreen select the Status area and then select the Speaker symbol to display the Bluetooth volume control for LightHouse™ app and MFD alarms.

Shortcuts page

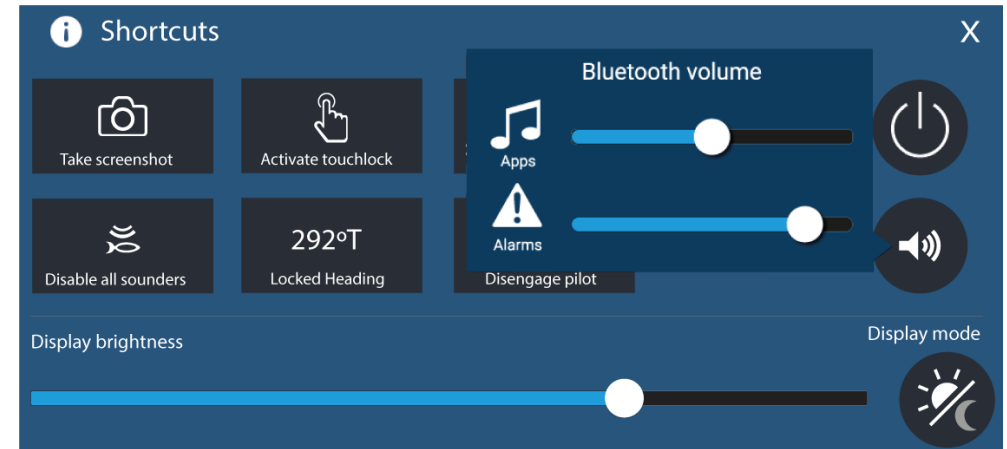

Press or swipe the *[Power]* button to display the Shortcuts page and then select the speaker symbol to display the Bluetooth volume control for LightHouse™ apps and MFD alarms.

CHAPTER 35: YACHTSENSE ECOSYSTEM

CHAPTER CONTENTS

- 35.1 YachtSense ecosystem — page 504
- 35.2 How to obtain the Raymarine app — page 506
- 35.3 Deleting a boat system — page 510
- 35.4 Unlinking (Removing) a router — page 511
- 35.5 YachtSense Link router account transfer / ownership transfer — page 513

35.1 YachtSense ecosystem

YachtSense is Raymarine's digital vessel monitoring and control solution. The YachtSense ecosystem enables on and off-boat monitoring and control of connected vessel systems and data.

On-boat monitoring and control can be achieved using Raymarine Axiom and Axiom 2 chartplotters (MFDs) or the Raymarine app installed on a mobile phone or tablet.

Off-boat (remote) monitoring and control can be achieved using the Raymarine app running on a compatible mobile phone or tablet. Off-boat monitoring and control also requires:

- A Premium subscription to the Raymarine app.
- Your system to have an active Internet connection.

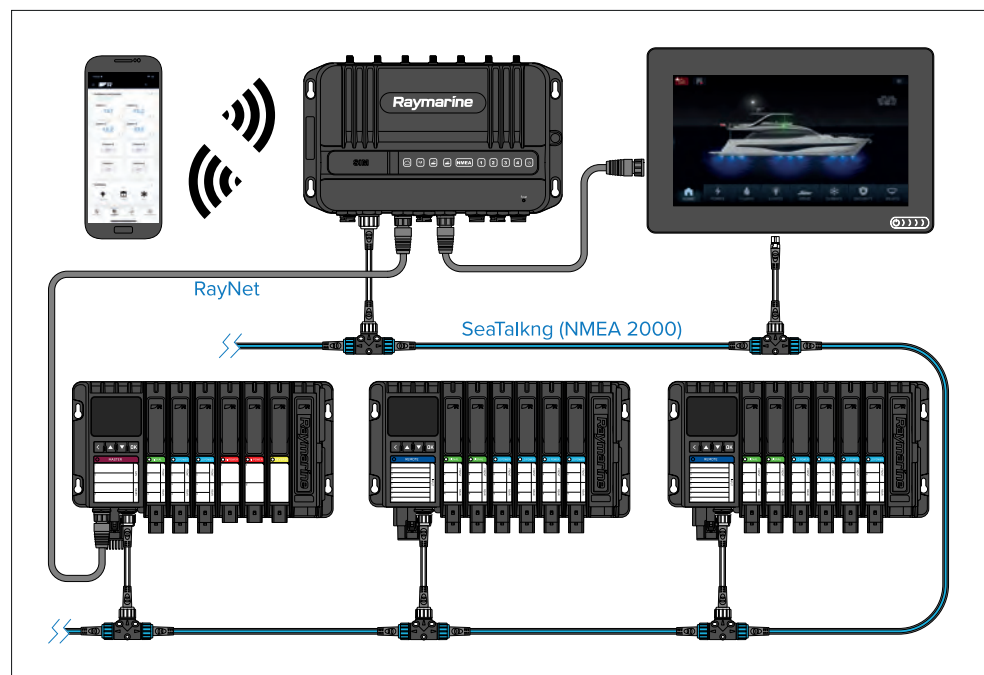

The full YachtSense ecosystem consists of:

- YachtSense Link router
- YachtSense Digital Control System, running Release 2 software (or later)
- Raymarine app.

- Premium app subscription (required for off-boat connectivity).
- Axiom/Axiom 2 chartplotter (MFD).

Note:

- The YachtSense Link router **must** be connected to the same SeaTalk NG backbone as the YachtSense Digital Control System, and any chartplotters (MFDs).
- The router **must** also have a RayNet connection to the YachtSense Digital Control System's Master module, and any chartplotters (MFDs).

On-boat features

The YachtSense ecosystem provides a number of “on-boat” features that can be used whilst onboard your vessel.

Raymarine app connected directly to a chartplotter (MFD)



The following features are available when using the Raymarine app on a mobile device that is connected directly to an Axiom/Axiom 2 chartplotter's (MFD's) Wi-Fi Access Point:

- Stream and control the display.
- Download and transfer LightHouse charts to a memory card, or the chartplotter's (MFD's) internal storage.
- Transfer files such as backups of waypoints and settings, images or videos between your mobile device and the chartplotter (MFD).
- View NMEA 2000 data.

Raymarine app connected to a YachtSense Link router

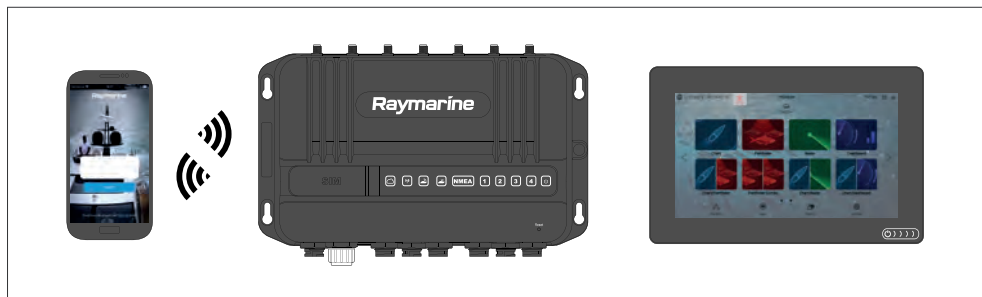

The following features are available when using the Raymarine app on a mobile device that is connected to the YachtSense Link router's Wi-Fi Access Point:

- Stream and control any chartplotter (MFD) on the network.
- Download and transfer LightHouse charts to a memory card or the chartplotter's (MFD's) internal storage.
- Transfer files such as backups of waypoints and settings, images or videos between your mobile device and the chartplotter (MFD).
- View NMEA 2000 data.
- Voltage monitoring of devices connected to the router's input channels. The router's web interface can also be used to monitor input channels.
- Control of devices connected to the router's output channels. The router's web interface can also be used to control output channels.

Raymarine app connected to a YachtSense Link router with a YachtSense Digital Control System

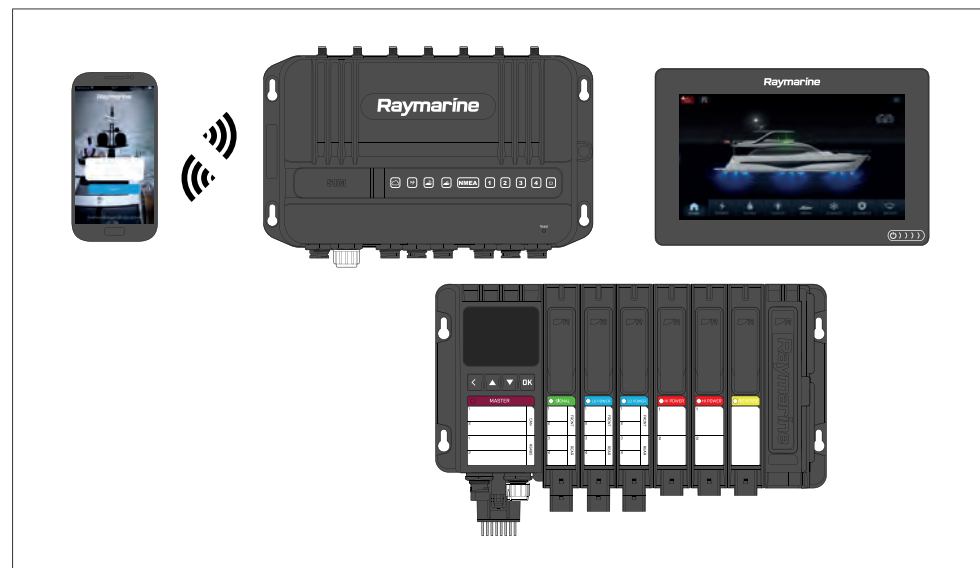

The following features are available when using the Raymarine app on a mobile device that is connected to the YachtSense Link router's Wi-Fi Access Point on systems that include a YachtSense Digital Control System:

- Stream and control any chartplotter (MFD) on the network.
- Download and transfer LightHouse charts to a memory card or to the chartplotter's (MFD's) internal storage.
- Transfer files such as waypoint and settings backups, images or videos between your mobile device and the chartplotter (MFD).
- View NMEA 2000 data. (The range of data that can be viewed is dependent on the specific configuration and design of your YachtSense ecosystem and the associated Raymarine app.)
- Voltage monitoring of devices connected to the router's input channels. The router's web interface can also be used to monitor input channels.
- Control of devices connected to the router's output channels. The router's web interface can also be used to control output channels.
- Monitoring and control of vessel systems and devices connected to the YachtSense Digital Control System input and output channels (input and output channels can also be monitored and controlled using a chartplotter (MFD), or directly from the Master or Remote module).

Note:

The YachtSense Digital Control System requires a specific configuration and app page design for the Raymarine app. Contact an authorized Raymarine dealer or the organization that configured your system for advice.

Off-boat premium features

The YachtSense ecosystem provides a number of premium “off-boat” features, which can be used whilst away from your vessel.

Note:

- Off-boat features require a YachtSense Link router and a valid premium subscription to the Raymarine app.
- Off-boat features require the system to have an active Internet connection.
- YachtSense Digital Control System requires a specific configuration and app page design for the Raymarine app. App software Release 2 (or later) is required.

Whilst off-boat you can:

- Monitor your vessel’s location using the app’s geofence features.
- View NMEA 2000 data. (The range of data that can be viewed is dependent on the specific configuration and design of your YachtSense ecosystem and the associated Raymarine app.)
- Voltage monitoring of devices connected to the router’s input channels.
- Control of devices connected to the router’s output channels.
- Monitoring and control of vessel systems and devices connected to the YachtSense Digital Control System input and output channels.





Note:

If the router is in *[Low power mode]* only a Cellular connection can be used to wake the router remotely.

35.2 How to obtain the Raymarine app

The Raymarine app is available for Android and Apple iOS devices, and can be installed on your mobile device from the relevant app store.

To obtain the Raymarine app from the relevant app store for your device, point your mobile device’s camera at one of the following QR codes:

Apple iOS	Android
 	 

Once you’ve installed the app, you will need to create a Raymarine account to log in to the app.

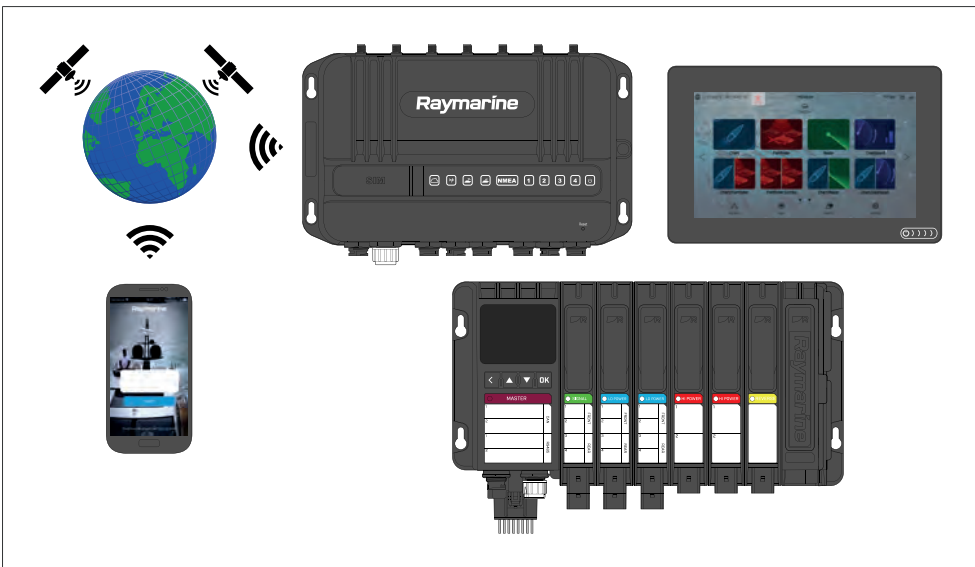

How to connect guide

If the app is not currently connected to a boat system, the *[How to connect]* option is available in the app to guide you through setting up a boat system and connecting to your chartplotter (MFD) or YachtSense Link router.

Connect directly to a chartplotter (MFD)

You must be connected directly to the chartplotter's (MFD's) Wi-Fi connection.

If your display does not have an Internet connection, you must log in to the Raymarine app first before switching network.

If your display does not have a connection to the Internet, when you connect to it, your mobile device may automatically revert to its previous network. If you try to connect again a notification is displayed. Select *[Connect]* or *[Connect anyway]*.

When you are connected to a chartplotter (MFD), you can:

- [Start display mirroring](#)
- [View data](#)
- [Transfer files](#)
- [Transfer LightHouse charts](#)

When connecting directly to a chartplotter (MFD) it must be configured to allow Wi-Fi sharing: *[Homescreen > Settings > This display > Wi-Fi Sharing]*.

Display mirroring (view and control)

You can view and control your chartplotter (MFD) from the Raymarine app.

Chartplotters (MFDs) will be available under *[Display mirroring]* in the *[Control]* tab when connected to the same Wi-Fi network as your mobile device. Select a chartplotter (MFD) to initiate display mirroring.

Display mirroring is always available when you are connected to the Router's Wi-Fi connection or to a chartplotter's (MFD's) Wi-Fi connection.

Transferring LightHouse charts

The Raymarine app can be used to redeem LightHouse chart vouchers and to download and transfer the charts directly to your chartplotter (MFD).

Note:

To download LightHouse charts to a memory card you must first purchase a pre-formatted LightHouse charts MicroSD card (part number: R70795 or R70838), and insert it into your chartplotter (MFD) before starting the transfer process.

1. Select the *[Management]* icon located at the bottom of the screen.
2. Select *[Charts]*.
If you have already purchased charts, they will be listed in the *[My charts]* menu. Otherwise, the *[Chart catalog]* is displayed where you can search for charts and redeem voucher codes.
3. Select the chart that you want to download, using the *[My charts]* menu.
4. Follow the onscreen instructions to download your charts.

During the download process, you will be able to group chart regions, Add [Streets & POI] and [Aerial photo] areas, and select a storage location.

Note:

Chart downloads have large file sizes and may take some time to download and transfer.

Chartplotter file transfer

File transfer between chartplotter (MFD) and your mobile device is available using the *[Chartplotter file transfer]* option in the *[Management]* tab.

If this is the first time that the file transfer has been attempted, you will need to confirm access from the chartplotter (MFD).

You can select a chartplotter (MFD) and then browse internal and external storage for either a file to be copied to your mobile device, or a location to upload a file from your mobile device.

Selecting a file from your chartplotter (MFD) provides the following related options:

- View the file
- Copy the file.

- Share the file.

You can also upload a file from your mobile device to your chartplotter (MFD) by selecting [\[Upload a file here\]](#).

Note:

You cannot use the Raymarine app to delete files that are stored on your chartplotter (MFD).

Connect to your YachtSense Link router

After setting up your YachtSense Link router and configuring its wireless networks (Wi-Fi and/or cellular (mobile) connections) you can use the Raymarine app to create a boat system and register your router to your Raymarine account. Registering allows off boat monitoring and control of compatible systems connected to your router.

Note:

- You cannot register a router that is already registered to a different account.
- If your mobile device is already connected to a boat system it must be disconnected before another boat system can be added.
- The premium subscription features can only be used on 2 boat systems at a time.

The registration process includes:

1. Connecting your mobile device to your YachtSense Link router's Wi-Fi connection.
2. Creating a boat system by entering your boat's name.
3. Scanning the router's QR code to register the router to your account. The QR code can be found on the label on the side of your router or on the Info page of the router's web interface.

When connected to the router you can:

- [Create geofences](#)
- [View data](#)
- [Control digital switching input and output channels](#)
- [Start display mirroring](#)

- [Transfer files](#)
- [Transfer LightHouse charts](#)

Geofencing

A Geofence is a security feature that alerts you if your boat leaves or enters a chosen area.

When a geofence alert is triggered a notification will be sent to the cellular telephone number specified in the [\[Boat alerts\]](#) settings.

Geofencing is available with a premium Raymarine app subscription.

Geofence

When your boat system includes a YachtSense Link router you can set up geofences.

1. Select [\[+ Add new geofence\]](#) from the Geofence tab.
2. Select [\[Radius\]](#).

A geofence circle is placed over your vessel.

3. Increase or decrease the geofence radius by selecting the circle and dragging towards or away from you vessel's location.

Alternatively you can use the [\[+\]](#) (plus) and [\[-\]](#) (minus) buttons to fine tune the circle radius.

4. Select the [\[Name\]](#) field to customize the geofence name.
5. Enable the [\[Boat leaves location\]](#) and/or [\[Boat enters location\]](#) toggle switches as appropriate for your needs.
6. If desired, change the color of the geofence by selecting the colored circle in the color area.
7. Select [\[Create\]](#) from the top of the screen.

Multiple geofences can be created. The geofence circle radius can be adjusted or can be disarmed by selecting the relevant geofence details located at the bottom of the screen.

Temporary mooring

You can also create temporary mooring geofences for short stay stops.

Temporary mooring geofences are only triggered when your vessel exits a geofence circle, and are automatically deleted when it is disarmed.

You can only have one temporary mooring geofence active at any one time. Creating a second temporary mooring geofence will replace the first geofence.

Data view and channel control

Depending on your system's configuration, you can use the app to view live data and control certain channels.

- A data page can be created in the app to view compatible data which is available on your network.

Note: When connected directly to a chartplotter (MFD) the data items available will be limited. Connecting to a YachtSense Link router will provide the maximum available data items.

- When connected to a boat system that includes a YachtSense Link router you can view the status of the input channels and switch the output channels on and off from the *[Control]* tab. If the channel has been disabled in the router's web interface, it will not be shown in the app.
- When your boat system includes both a YachtSense Link router and a YachtSense Digital Control System, the status and control of the input and output channels is available from the *[Control]* tab.
- When you have an active premium Raymarine app subscription and your boat system includes both a YachtSense Link router and a YachtSense Digital Control System, the status and control of the input and output channels can be accessed remotely when you are away from your boat.

Note:

In order for YachtSense Digital Control System controls to be available on the app, your YachtSense Digital Control System configuration must include the necessary app page layouts. If required, please contact your YachtSense Digital Control System installer, who will need to create an updated configuration for your system.

Viewing NMEA 2000 data

To create a data page for NMEA 2000 data, follow the steps below.

1. Select *[Add data]* from the Data tab.
2. Select a data category and then select the relevant data item.

3. To add more data items, select the *[+]*(plus) icon and repeat steps 2 and 3.
4. When finished, select *[Done]*.

To delete a data item, press and hold and then drag it to the *trash bin* icon at the bottom of the screen.

You can add or change data items at any time by selecting the *[Edit]* icon, located at the top of the data page.

User access management

You can log out / in to your account, edit your user account details or update your premium plan subscription by selecting the profile icon on the right side of the side menu.

Guest mode

The Raymarine app may be used to connect to a different YachtSense system/Raymarine account in guest mode. (e.g.: If you are on a friend's boat or borrowing / chartering a boat that includes a Raymarine® display or YachtSense Link router).

You must be connected to the Router's Wi-Fi access point or a display's Wi-Fi access point and using the Raymarine app logged in to an account that is not linked to that system.

Guest mode allows you to use the screen mirroring feature to view and control Raymarine® displays that are connected to that system.

Note:

In guest mode no off boat features are available and you will not be able to onboard a router, use geofences, view or control YachtSense Link and YachtSense Digital Control System input and output channels, upload files or transfer LightHouse charts.

Boat alerts

Alerts raised by your system can be viewed in the app by selecting *[Boat alerts]* from the side menu.

You can also enter a cellular telephone number to automatically receive boat alerts on your mobile device remotely.

The cellular telephone number can be entered by selecting the settings icon from the *[Boat alerts]* menu.

Boat systems

You can create up to 10 boat systems on the Raymarine app. With an active premium Raymarine app subscription up to 2 boat systems can be configured to receive premium features.

35.3 Deleting a boat system

A boat system can be deleted from the Raymarine app following the steps below:

1. Select the menu icon located on the left of the screen to open the side menu.
2. Select and hold on the boat system of the boat you want to remove.

If you have more than one boat set up, you will first need to select the relevant boat system from the dropdown list.

3. Select *[Delete]* and then confirm the deletion.

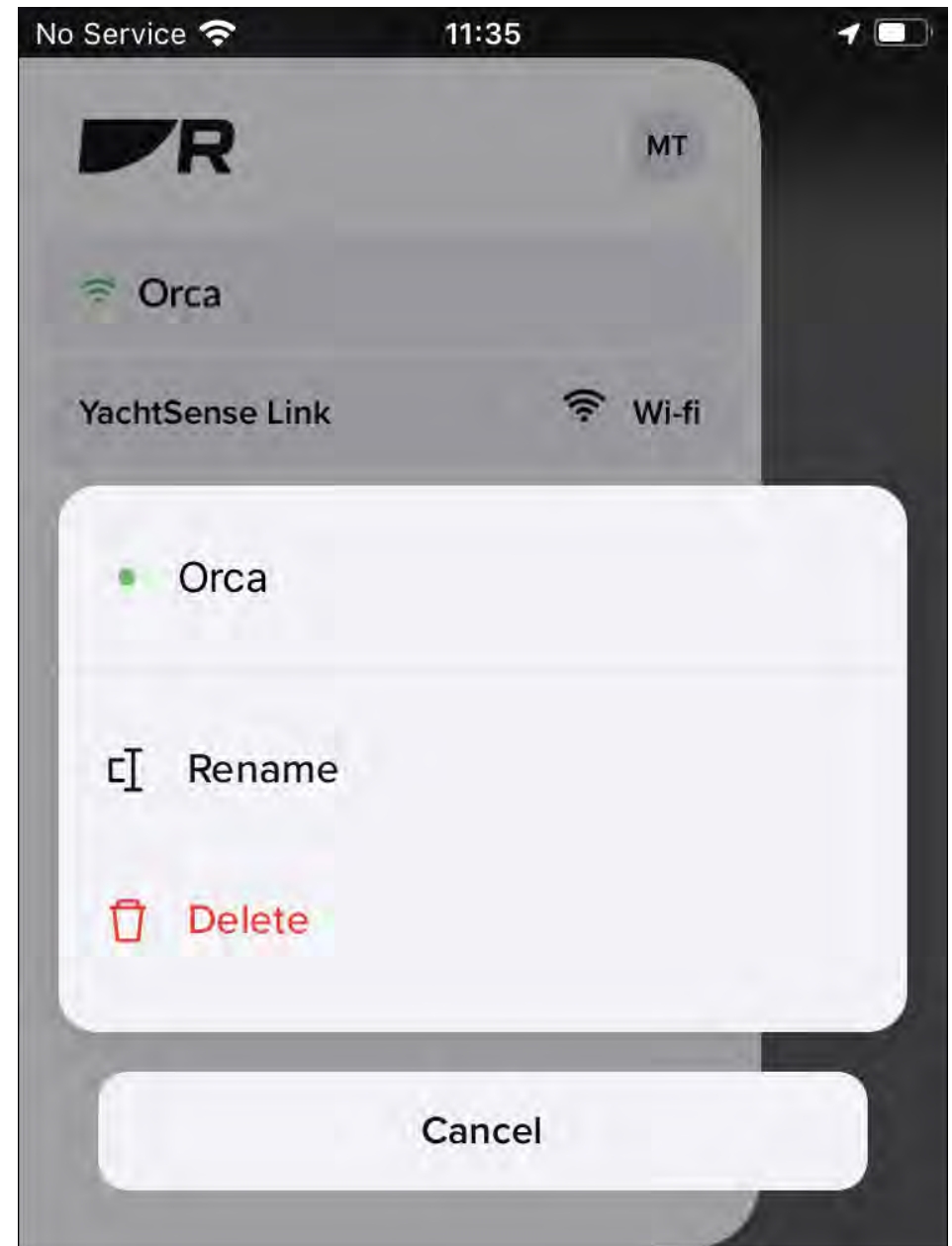

4. Select *[Delete]* again to confirm.

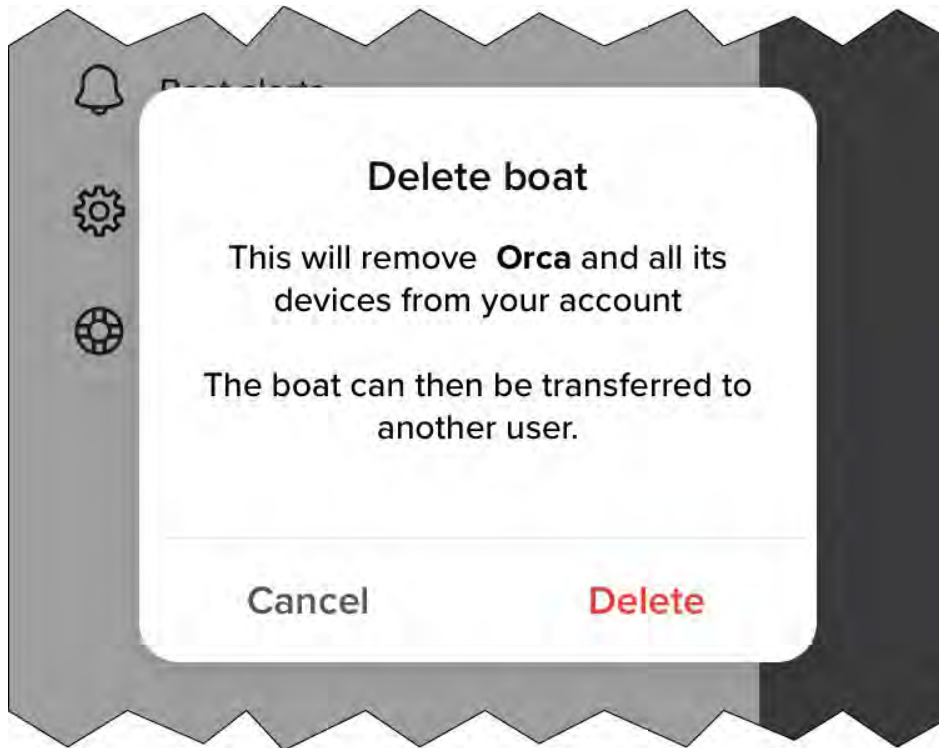

5. Select *[OK]*.

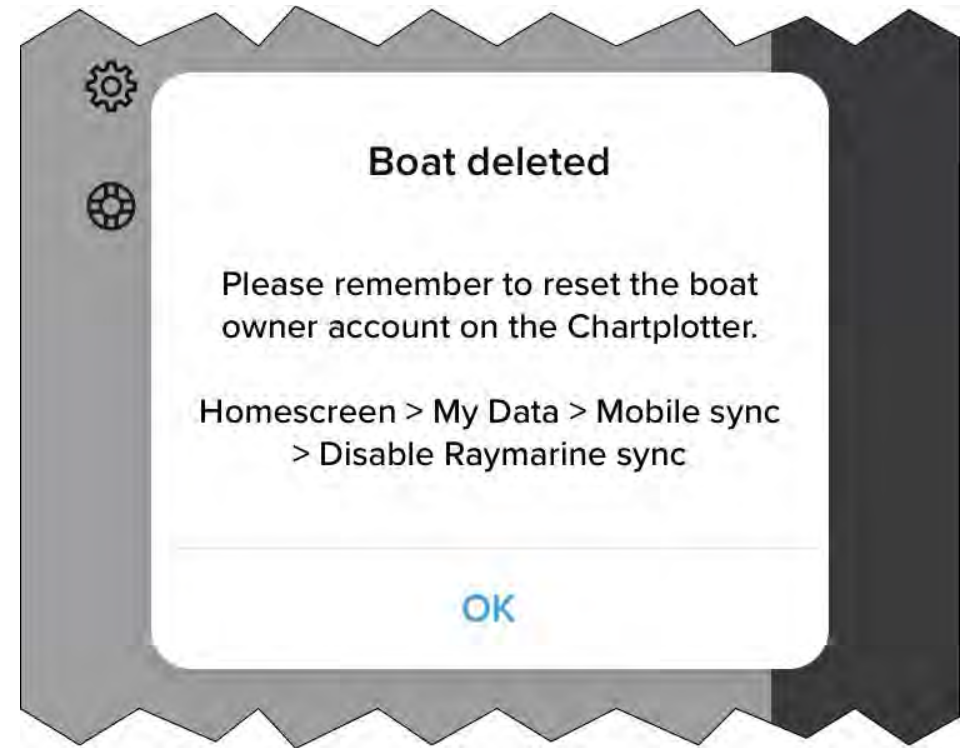

6. You must also unsync the MFD from the Raymarine app by accessing the *[My data]* menu on your MFD and selecting *[Mobile sync]* and *[Cancel Raymarine sync]*.

The boat system and all of its devices are now deleted from your app. If the deleted boat system included a YachtSense link router then the router will also be unlinked from your account and can now be linked (onboarded) again to the same account, or to a different account.

35.4 Unlinking (Removing) a router

You can remove a YachtSense Link router from a boat system in the Raymarine app by following the steps below.

1. Select the menu icon located on the left of the screen to open the side menu.

2. If you have more than one boat system, select the relevant boat system that the router is connected to.
3. Select the *[YachtSense Link]* router.
4. Select *[Remove]*.

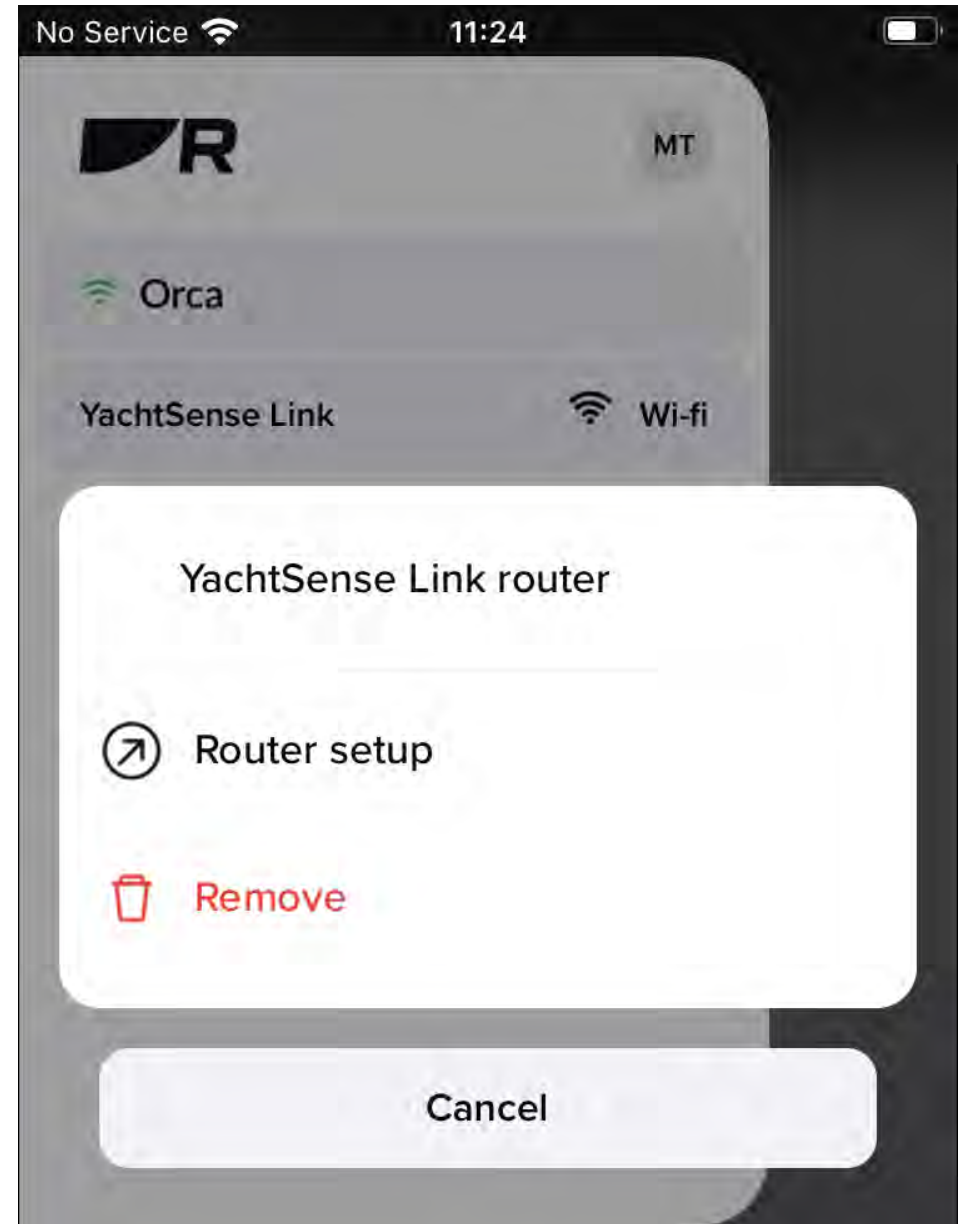

5. Confirm by selecting *[Remove]*.

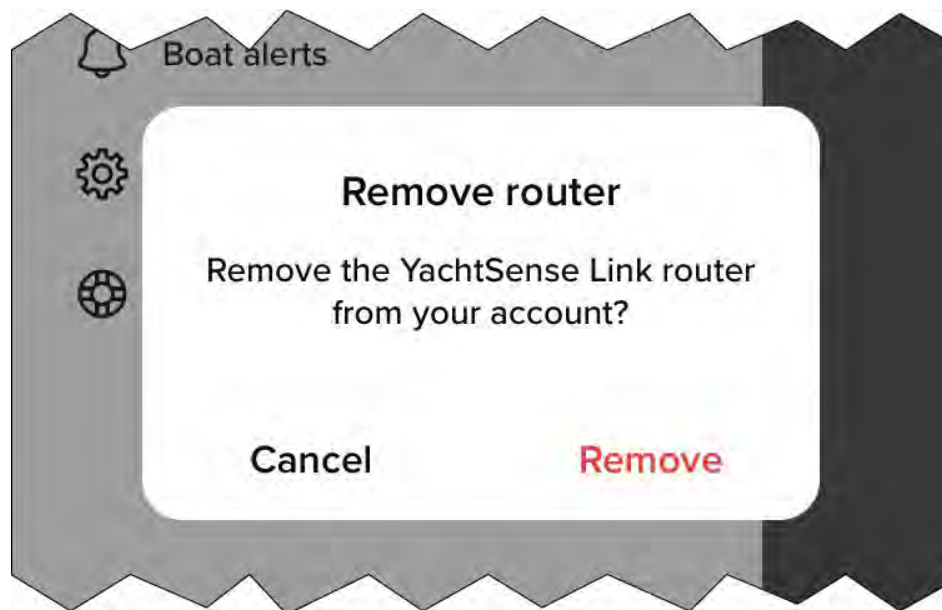

If you cannot contact the previous owner, Raymarine technical support may be able to contact them on your behalf.

In most cases if the previous owner cannot be reached or is unwilling to deregister the router from their account, it will NOT be possible for you to register the router.

If you purchased the router new, via either a third party reseller or as a refurbished unit, and you receive a message that your router is already registered to an account, you should return it to the seller for a refund or exchange and let them know that it is already registered to another account.

6. You must also unsync the MFD from the Raymarine app by accessing the *[My data]* menu on your MFD and selecting *[Mobile sync]* and *[Cancel Raymarine app sync]*.

The router is now removed from the boat system and unlinked from your account. The router can now be linked again to the same account, or to a different account.

35.5 YachtSense Link router account transfer / ownership transfer

YachtSense Link routers can only be registered to one account at a time.

To register the router to a different account it must first be deregistered from the existing account. For instructions refer to: [Removing a router](#)

Attempts to register a router that is already registered will fail.

If you receive a message when trying to register your router that states it is already registered to another account, you will need to contact the previous owner and ask them to deregister the router from their account.

CHAPTER 36: TROUBLESHOOTING

CHAPTER CONTENTS

- 36.1 Troubleshooting — page 515
- 36.2 Diagnostic product information — page 515
- 36.3 RNS-8 Diagnostic information — page 516
- 36.4 NMEA 0183 diagnostics — page 517
- 36.5 NMEA 2000 diagnostics — page 518
- 36.6 Power up troubleshooting — page 519
- 36.7 Radar troubleshooting — page 521
- 36.8 GNSS (GPS) troubleshooting — page 522
- 36.9 Sonar troubleshooting — page 523
- 36.10 Camera troubleshooting — page 527
- 36.11 Augmented Reality (AR) Troubleshooting — page 529
- 36.12 Wi-Fi troubleshooting — page 530
- 36.13 IP address conflict troubleshooting — page 532
- 36.14 Wireless display troubleshooting — page 533
- 36.15 Data troubleshooting — page 533
- 36.16 Touchscreen troubleshooting — page 534

36.1 Troubleshooting

The troubleshooting section provides possible causes and the corrective action required for common problems that are associated with the installation and operation of your product.

Before packing and shipping, all Raymarine products are subjected to comprehensive testing and quality assurance programs. If you do experience problems with your product, this section will help you to diagnose and correct problems to restore normal operation.

If after referring to this section you are still having problems with your product, please refer to the *Technical support* section of this manual for useful links and Raymarine technical support contact details.

36.2 Diagnostic product information

Diagnostic product information can be viewed from your MFD, for products networked using SeaTalkhs® and SeaTalkng® / NMEA 2000.

To view diagnostic product information, select *[View all product info]* from the *[Diagnostics]* pop over menu: *[Homescreen > Settings > Network > Diagnostics > View all product info]*.

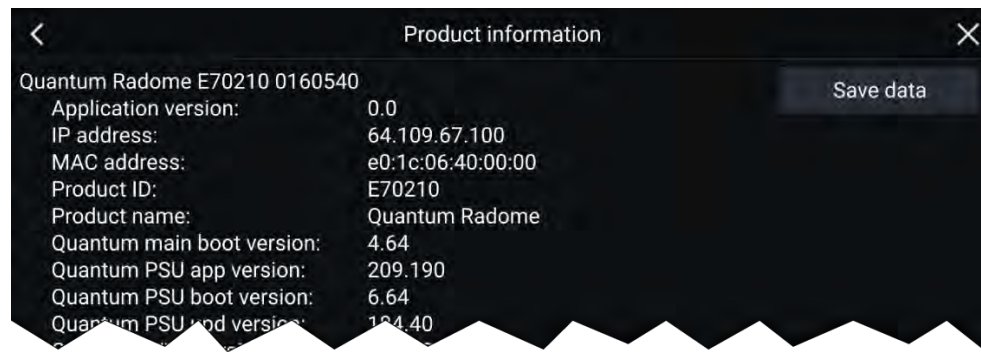

Saving product information

Diagnostic product information can be saved to a MicroSD card for off boat records.

With the Diagnostics product information page displayed:

1. Select *[Save data]*.

Troubleshooting

2. Select the storage device you want to save the data to.
3. Enter a filename.
4. Select *[Save]*.
5. Select *[OK]*.

A .json file will be saved, using your chosen filename to your memory card.

You may view the file using a most standard notepad applications.

Saving crash and system logs

System logs and crash logs can be saved to memory card so that if requested by Technical support during troubleshooting they can be sent to Raymarine.

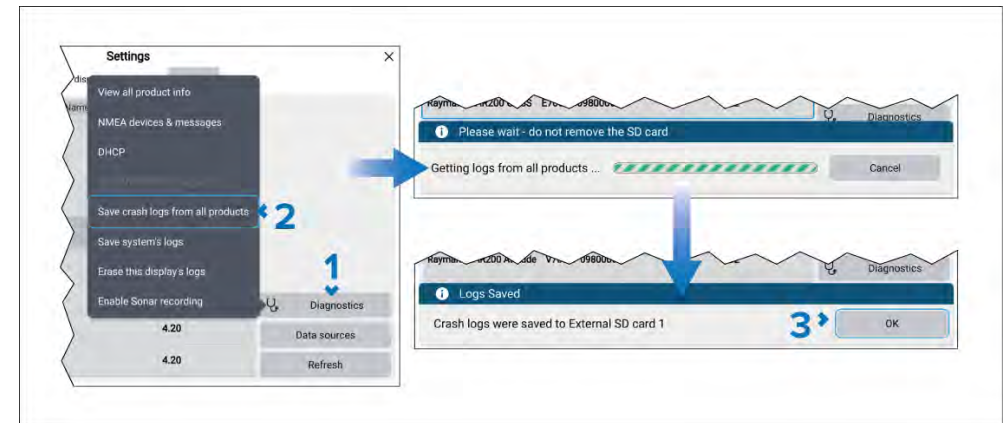

1. Select the *[Diagnostics]* button from the Network settings menu: *[Homescreen > Settings > Network > Diagnostics]*.
2. Select either:
 - *[Save this display's logs]*— Only logs from this display will be saved.
 - *[Save crash logs from all products]*— Logs from all networked devices will be saved.
 - *[Save system logs]*— Only system logs will be saved.
3. Select *[OK]* on the 'Logs saved' dialog.

The logs will be saved to a 'logs' folder that will be created on your memory card. The logs will be compressed as a '.zip' file ready to be sent to Raymarine.

Saving YachtSense Link logs

Logs held on the YachtSense™ Link router can be saved to memory card on a display running LightHouse™ V4.1 or greater.

Note:

Savings crash logs using the *[Save crash logs from all products]* option available from the *[Diagnostic]* button will include YachtSense™ Link router logs. The below steps will only save the router's logs.

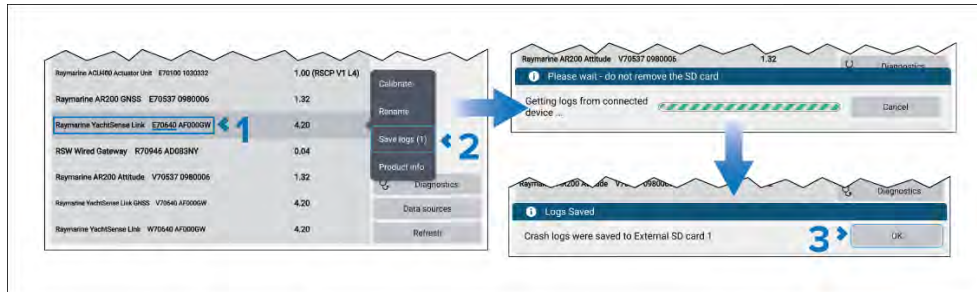

1. Select the YachtSense™ Link router button from the list of Networked devices: *[Homescreen > Settings > Network > Raymarine YachtSense Link E70640 xxxxxxxx]*.

The network list will include 3 entries for the router, the correct option is the device that includes the router's part number i.e.: E70640.

2. Select *[Save logs]* from the pop-over options.
3. Select *[OK]* on the 'logs saved' dialog.

The logs will be saved to a 'logs' folder that will be created on your memory card. The logs will be compressed as a '.zip' file ready to be sent to Raymarine.

36.3 RNS-8 Diagnostic information

The following range of diagnostic information is available for the RNS-8 Network switch, which can be displayed on LightHouse™ 4 multifunction displays running software **version 4.5 or later**.

To view RNS-8 diagnostic product information on a LightHouse™ 4 multifunction display, select *[RNS-8]* from the *[Diagnostics]* pop over menu on the multifunction display: *[Homescreen > Settings > Network > Diagnostics > RNS-8]*.

The following diagnostic information is displayed:

RNS-8 network switches			
Name	Address	Serial	Version
RNS-8	198.18.6.7	A80732 AG8KB9F	V0.42
RNS-8	198.18.5.185	A80732 AGCSH25	V0.42

Diagnostic

Description

Name:	Provides the product name.
Address:	Provides the product IP address.
Serial:	Provides the product serial number.
Version:	Provides the product software version number.

Additional port diagnostic information can be displayed by tapping the row for the relevant unit and then selecting *[Port traffic]*. Once selected, the following port diagnostic information is displayed:

Port	Throughput (Bytes)	Total Throughput (Bytes)	Speed (bps)	Negotiated Speed (Mbps)	POE Class	Power (W)
1	32680	2416729593	261440	1000	1 (4.0W)	2.53
2	66008	1631084735	528064	1000		
3	0	0	0	0	Unknown	0.00
4	0	0	0	0		
5	0	0	0	0	Unknown	0.00
6	0	0	0	0		
7	32193	2517796595	257544	100	2 (7.0W)	3.52
8	68552	1859172982	548416	1000		

Diagnostic

Description

POE Class (Watts) — (PoE ports 1, 3, 5, 7):

Provides the PoE classification of a connected PoE Powered Device (PD), and the maximum power consumption (Watts) required by the PoE classification.

Power (Watts) — (PoE ports 1, 3, 5, 7):

Provides the current power consumption (Watts) of your connected Powered Device (PD).

Note: The network switch can output a maximum of 120 Watts, for consumption by up to 4 PoE Powered Devices (i.e. 30 W maximum *per Powered Device*).

36.4 NMEA 0183 diagnostics

You can view and record data transmitted to and received from connected NMEA 0183 devices. This can help in troubleshooting device/data issues and the resulting log may be requested by Technical support when discussing technical issues.

Note:

The NMEA 0183 diagnostics option is available on Axiom™ Pro and Axiom™ XL displays. The menu is not available on Axiom™, Axiom™+, Axiom™ 2 Pro or Axiom™ 2 XL displays.

The diagnostics menu is opened by selecting the *[NMEA0183 messages]* option from the *[Diagnostics]* button: *[Homescreen > Settings > Network > Diagnostics > NMEA0183 messages]*.

Diagnostic

Description

Throughput (Bytes) — (port 1–8):

Provides the current amount of data (Bytes) that is currently being transferred via your network switch from a specific port.

Total Throughput (Bytes) — (port 1–8):

Provides the total amount of data (Bytes) that has been transferred via your network switch from a specific port.

Speed (Bps) — (port 1–8):

Provides the current data transfer speed (in Bytes per second) for a specific port.

Negotiated Speed (Mbps) — (port 1–8):

Provides the port's maximum data transfer speed (10/100/1000 Mbps), which is negotiated during connection.

36.5 NMEA 2000 diagnostics

You can view and record data transmitted to and received from connected NMEA 2000 / SeaTalkng[®] devices. This can help in troubleshooting device/data issues and the resulting log may be requested by Technical support when discussing technical issues.

The diagnostics menu is opened by selecting the *[NMEA devices & messages]* option from the *[Diagnostics]* button: *[Homescreen > Settings > Network > Diagnostics > NMEA devices & messages]*.

The menu will display a list of connected devices.

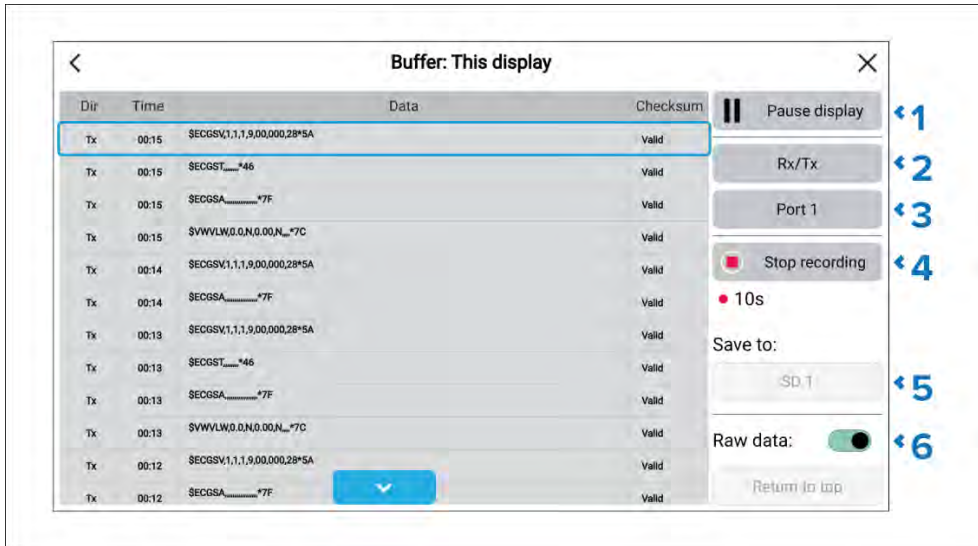

From the diagnostics menu you can:

1. *[Resume display]* *[Pause display]*— Select button to start or stop display of data.
2. *[Rx/Tx]* — Select to filter between *[Rx]* (Received data) and *[Tx]* (Transmitted data), or both *[Rx/Tx]*.
3. *[Port 1]* *[Port 2]*— Select to switch between NMEA 0183 ports.
4. *[Start recording]* *[Stop recording]*— Select to start or stop recording data to a memory card. The data will be saved to a .log file in the root directory of the memory card.
5. *[Save to:]* — Select to choose a card reader slot to save the data to.
6. *[Raw data]*— Disable to view a more user friendly description of the data. When enabled the raw data is displayed. Only raw data is recorded to memory card.

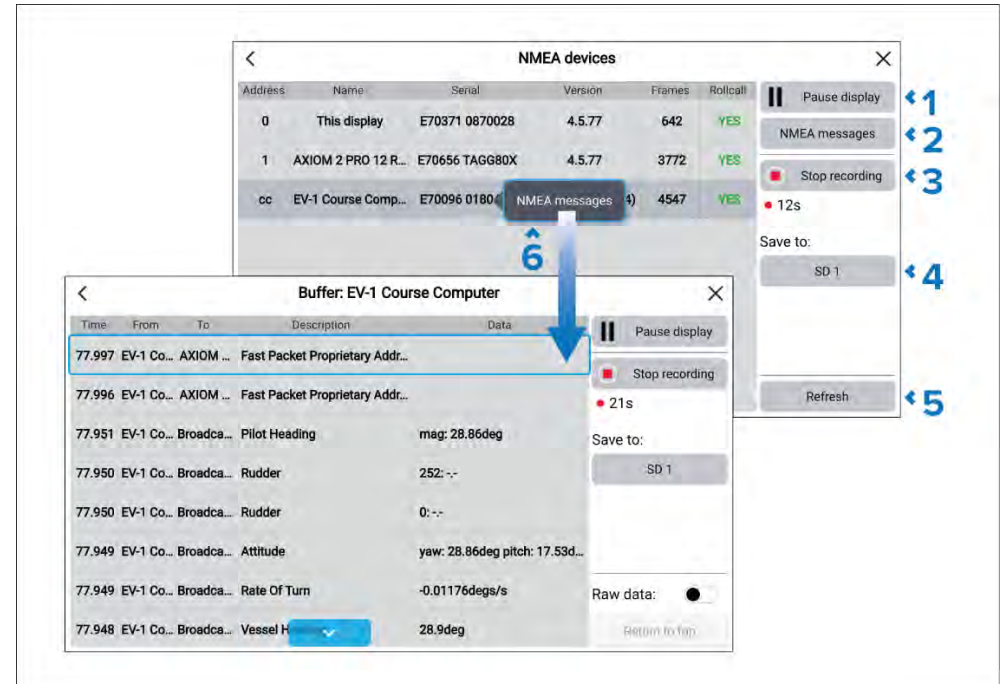

From the diagnostics menu you can:

1. *[Resume display]* *[Pause display]*— Select button to start or stop display of data.
2. *[NMEA messages]*— Select to display a list of all transmitted and received data from all devices..
3. *[Start recording]* *[Stop recording]*— Select to start or stop recording data to a memory card. The data will be saved to a .log file in the root directory of the memory card.

4. *[Save to:]* — Select to choose a card reader slot to save the data to.
5. *[Refresh]* — Select to refresh the list of devices.
6. *[NMEA messages]* — Select a device from the list and select NMEA messages to view a list of messages for that device.

36.6 Power up troubleshooting

Product does not turn on or keeps turning off:

Possible causes	Possible solutions
Blown fuse / tripped breaker:	<ol style="list-style-type: none"> 1. Check condition of relevant fuses and breakers and connections, replace if necessary. (Refer to the <i>Technical Specification</i> section of your product's installation instructions for fuse ratings.) 2. If fuse keeps blowing check for cable damage, broken connector pins or incorrect wiring.
Poor / damaged / insecure power supply cable / connections:	<ol style="list-style-type: none"> 1. Check that the power cable connector is correctly orientated and fully inserted into the display connector and locked in position. 2. Check the power supply cable and connectors for signs of damage or corrosion, and replace if necessary. 3. With the display turned on, try flexing the power cable near to the display connector to see if this causes the unit to restart or lose power. Replace if necessary. 4. Check the vessel's battery voltage and the condition of the battery terminals and power supply cables, ensuring connections are secure, clean and free from corrosion. Replace if necessary. 5. With the product under load, using a multi-meter, check for high voltage drop across all connectors / fuses etc, and replace if necessary.
Incorrect power connection:	The power supply may be wired incorrectly, ensure the installation instructions have been followed.

Product will not start up (restart loop):

Possible causes	Possible solutions
Power supply and connection:	See possible solutions from the table above, entitled 'Product does not turn on or keeps turning off'.
Software corruption:	<ol style="list-style-type: none"> 1. In the unlikely event that the product's software has become corrupted, try downloading and installing the latest software from the Raymarine website. 2. On display products, as a last resort, attempt to perform a 'Power on Reset'. Be aware that this will delete all settings / presets and user data (such as waypoints and tracks), and revert the unit back to factory defaults.



Warning: Factory reset warning

Performing a factory reset will restore all system and app settings to factory defaults and erase all user data (such as waypoints, routes, tracks, camera recordings and photos).

Performing a power on reset on touch only displays

Important:

- Before performing a power on reset ensure you have backed up your settings and user data (waypoints, routes and tracks) to a memory card.
- You may also want to save any crash logs that are stored on your display to memory card for future reference.

1. Switch off power at the breaker to ensure that the display is completely powered off, and not in Standby mode. Alternatively, remove the power cable from the display.
2. Power on your display, and within approximately 10 seconds, swipe your finger from right to left (opposite direction to powering on) across the *[Power]* button swipe area 5 times.
Recovery options are displayed.
3. Swipe your finger from right to left twice to highlight *[Wipe data/factory reset]*.
4. Swipe your finger from left to right once to accept.

5. Swipe your finger from right to left once to highlight *[Yes]*.
6. Swipe your finger from left to right once to restore your display to factory default settings.
7. When *[Data wipe complete]* is displayed, swipe your finger from left to right to restart your display.

Performing a power on reset on an Axiom® Pro display

Important:

Before performing a power on reset ensure you have backed up your settings and user data to a memory card.

1. Switch off power at the breaker to ensure that the display is completely powered off, and not in Standby mode. Alternatively, remove the power cable from the display.
2. Within approximately 10 seconds of powering on your display, press and hold the *[Back]* and *[Switch active]* buttons until the screen goes black and the Raymarine logo appears.
The display will boot into Recovery mode.
3. Use the directional controls to highlight *[Wipe data/factory reset]*.
4. Press *[Ok]*.
5. Select *[Yes]* to restore your display to factory default settings.
6. When 'Data wipe complete' is displayed, select *[Reboot system]* now.

Performing a power on reset on an Axiom® 2 Pro display

Important:

Before performing a power on reset ensure you have backed up your settings and user data to a memory card.

1. Switch off power at the breaker to ensure that the display is completely powered off, and not in Standby mode. Alternatively, remove the power cable from the display.
2. Plug the power cable back in or turn the breaker back on.

3. If the display was previously in Standby then press the power button to power up the display, otherwise the display will power up when the power supply is reconnected.
4. Within approximately 10 seconds of powering on your display, press and hold the *[Back]* and *[Menu]* buttons until the screen goes black and the Raymarine logo appears.
The display will boot into Recovery mode.
5. Use the directional controls to highlight *[Wipe data/factory reset]*.
6. Press *[Ok]*.
7. Use the directional controls to highlight *[Factory data reset]*.
8. Press *[Ok]*.
9. When 'Data wipe complete' is displayed, select *[Reboot system now]*.
10. Press *[Ok]*.

36.7 Radar troubleshooting

No connection can be made to the scanner

Possible Causes	Possible Solution
Radar powered down	<ul style="list-style-type: none"> • If the scanner product has shut down, power it up by opening the Radar app and selecting the <i>[Power]</i> icon. • A Quantum Radar will shut down after 30 minutes if neither a wired (RayNet) , nor a wireless (Wi-Fi) connection can be made to a MFD.
Radar not transmitting	<ul style="list-style-type: none"> • Select <i>[Transmit]</i> for the relevant Radar scanner from the Radar app.
Missing or incorrect Wi-Fi credentials	<ul style="list-style-type: none"> • If using a wireless (Wi-Fi) connection, check that you have entered the correct SSID and passcode for your Radar. Both the SSID and passcode are provided on the Radar scanner's packaging, and are also shown on the serial number label on the underside of the product.

Possible Causes	Possible Solution
Damaged or disconnected Power cable / RayNet cable	<ol style="list-style-type: none"> 1. Check that the cable connectors are fully inserted and locked in position. 2. Check the power supply cable and connectors for signs of damage or corrosion, replace if necessary. 3. With the product turned on, try flexing the cable near to the display connector to see if this causes the product to re-boot/lose power, replace if necessary. 4. Check the vessel's battery voltage, the condition of the battery terminals and power supply cables, ensuring connections are secure, clean and free from corrosion, replace if necessary. 5. With the product under load, using a multi-meter, check for high voltage drop across all connectors/fuses etc (this can cause the product to reset/turn off), replace if necessary. 6. Check condition of relevant breakers and fuses, replace if necessary. If the breaker keeps tripping or fuses keep blowing, contact a Raymarine authorized dealer for assistance.
Open Array power in Off position	<ul style="list-style-type: none"> • Ensure Open Array power switch is in the On position.
Software mismatch between equipment may prevent communication	<ul style="list-style-type: none"> • Ensure all Raymarine products contain the latest available software, check the Raymarine website: www.raymarine.com/software for software compatibility.

Poor image quality

Possible Causes	Possible Solution
High network bandwidth usage may interfere with a Quantum Radar connected wirelessly	<ul style="list-style-type: none"> • Disconnect Wireless display and close the Wireless display page. • Disconnect other devices connected wirelessly.

Displayed bearing is different to the true bearing

Possible Causes	Possible Solution
Bearing alignment adjustment required	<ul style="list-style-type: none"> • Carry out the Bearing Alignment procedure.

Radar will not initialize (Voltage control module (VCM) stuck in “sleep mode”

Possible Causes	Possible Solution
Intermittent or poor power connection	Check power connection at VCM. (Voltage at input = 12 / 24 V, Voltage at output = 40 V)

Changing Quantum radar channel

In rare circumstances Radar noise which cannot be eliminated using the Radar app's *[Sensitivity]* settings may be fixed by changing the Radar's internal wired adaptor channel.

Note:

- This feature requires Quantum 2 software version 2.50 (or later) / Quantum software version 2.44 (or later) and LightHouse™ 4 MFD software version 4.3.54 (or later).
- In the first instance you should try adjusting *[Sensitivity]* settings to eliminate the noise before changing the *[Wired adaptor channel]*.

Follow the steps below to change the channel from your display:

1. Select the *[Installation]* tab from the Radar app menu: (*[Menu > Settings > Installation]*).

2. Select the *[Wired Adapter Channel]* field.

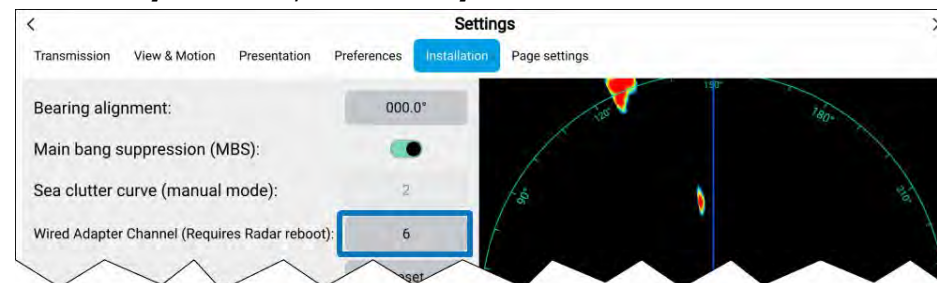

3. Change the channel to a different number.
4. Reboot the Radar scanner for the changes to take effect.

36.8 GNSS (GPS) troubleshooting

No fix displayed

Possible causes	Possible solutions
Geographic location or prevailing conditions preventing satellite fix.	Check to see if a fix is obtained in better conditions or another geographic location.
GNSS (GPS) connection fault.	Ensure that external GNSS (GPS) connections and cabling are correct and fault free.
External GNSS (GPS) receiver in poor location e.g.: <ul style="list-style-type: none"> • Below decks. • Close proximity to transmitting equipment, such as a VHF radio. 	Ensure GNSS (GPS) receiver has a clear view of the sky.
GNSS (GPS) installation problem.	Refer to the installation instructions supplied with your product.

Note: A GNSS (GPS) Status screen is accessible from the display. This provides satellite signal strength and other relevant information.

36.9 Sonar troubleshooting

Scrolling image is not being displayed

Possible causes	Possible solutions
Sonar disabled	Enable <i>[Ping]</i> from the Fishfinder app's sounder tab: <i>[Menu > Settings > Sounder > Ping enable]</i> .
Incorrect transducer selected	Check that the correct transducer is selected in the Fishfinder app's Transducer tab: <i>[Menu > Settings > Transducer]</i> .
Damaged cables	<ol style="list-style-type: none"> 1. Check that the transducer cable connector is fully inserted and locked in position. 2. Check the power supply cable and connectors for signs of damage or corrosion, replace if necessary. 3. With the unit turned on, try flexing the cable near to the display connector to see if this causes the unit to re-boot/lose power, replace if necessary. 4. Check the vessel's battery voltage, the condition of the battery terminals and power supply cables, ensuring connections are secure, clean and free from corrosion, replace if necessary. 5. With the product under load, using a multi-meter, check for high voltage drop across all connectors/fuses etc (this can cause the Fishfinder applications to stop scrolling or the unit to reset/turn off), replace if necessary.
Damaged or fouled transducer	Check transducer condition, ensuring it is not damaged and is free from debris/fouling. If necessary, clean or replace your transducer. After cleaning or replacement coat the transducer using a water-based anti-fouling paint.
Wrong transducer fitted	Check product and transducer documentation and ensure that the transducer is compatible with your system.

Possible causes	Possible solutions
External sonar module: SeaTalkhs / RayNet network problem.	<ul style="list-style-type: none"> • Check that the unit is correctly connected to the Display or network switch. Check all connections ensuring connections are secure, clean and free from corrosion, replace if necessary.
External sonar module: Software mismatch between equipment may prevent communication.	Ensure all Raymarine products contain the latest available software, check the Raymarine website: www.raymarine.com/software for software compatibility.

No depth reading / lost bottom lock

Possible causes	Possible solutions
Transducer location	Check that the transducer has been installed in accordance with the instructions provided with the transducer.
Transducer angle	If the transducer angle is too great the beam can miss the bottom, adjust transducer angle and recheck.
Transducer kicked-up	If the transducer has a kick-up mechanism, check that it has not kicked up due to hitting an object.
Power source insufficient	With the product under load, using a multi-meter, check the power supply voltage as close to the unit as possible to establish actual voltage when the current is flowing. (Check your product's Technical specification for power supply requirements.)
Damaged or fouled transducer	Check transducer condition, ensuring it is not damaged and is free from debris/fouling. If necessary, clean or replace your transducer. After cleaning or replacement coat the transducer using a water-based anti-fouling paint.

Possible causes	Possible solutions
Damaged cables	<ol style="list-style-type: none"> 1. Check the unit's connector for broken or bent pins. 2. Check that the cable connector is fully inserted into the unit and that the locking collar is in the locked position. 3. Check the cable and connectors for signs of damage or corrosion, replace if necessary. 4. With the unit turned on, try flexing the power cable near to the display connector to see if this causes the unit to re-boot/lose power, replace if necessary. 5. Check the vessel's battery voltage, the condition of the battery terminals and power supply cables, ensuring connections are secure, clean and free from corrosion, replace if necessary. 6. With the product under load, using a multi-meter, check for high voltage drop across all connectors/fuses etc (this can cause the Fishfinder applications to stop scrolling or the unit to reset/turn off), replace if necessary.
Vessel speed too high	Slow vessel speed and recheck.
Bottom too shallow or too deep	The bottom depth may be outside of the transducers depth range, move vessel to shallower or deeper waters as relevant and recheck.
Ping depth limit set	<p>If using a transducer with greater than 600 W power, check if the <i>[Ping depth limit]</i> has been enabled: <i>[Menu > Settings > Transducer > Ping depth limit]</i>.</p> <p>If you are in water deeper than the specified <i>[Ping depth limit]</i> then the transducer may not provide depth readings.</p> <p>Disable or adjust setting and retry.</p>

Poor / problematic image

Possible causes	Possible solutions
Targets will appear differently if your vessel is stationary (e.g.: fish will appear on the display as straight lines).	Increase vessel speed.
Scrolling paused or speed set too low	Unpause or increase sonar scrolling speed.
Sensitivity settings may be inappropriate for present conditions.	Check and adjust sensitivity settings or perform a Sonar reset.
Damaged cables	<ol style="list-style-type: none"> 1. Check the unit's connector for broken or bent pins. 2. Check that the cable connector is fully inserted into the unit and that the locking collar is in the locked position. 3. Check the cable and connectors for signs of damage or corrosion, replace if necessary. 4. With the unit turned on, try flexing the power cable near to the display connector to see if this causes the unit to re-boot/lose power, replace if necessary. 5. Check the vessel's battery voltage, the condition of the battery terminals and power supply cables, ensuring connections are secure, clean and free from corrosion, replace if necessary. 6. With the product under load, using a multi-meter, check for high voltage drop across all connectors/fuses etc (this can cause the Fishfinder applications to stop scrolling or the unit to reset/turn off), replace if necessary.

Possible causes	Possible solutions
Transducer location	<ul style="list-style-type: none"> Check that the transducer has been installed in accordance with the instructions provided with the transducer. If a transom mount transducer is mounted too high on the transom it may be lifting out of the water, check that the transducer face is fully submerged when planing and turning.
Transducer kicked-up	If the transducer has a kick-up mechanism, check that it has not kicked up due to hitting an object.
Damaged or fouled transducer	Check transducer condition, ensuring it is not damaged and is free from debris/fouling. If necessary, clean or replace your transducer. After cleaning or replacement coat the transducer using a water-based anti-fouling paint.
Damaged transducer cable	Check that the transducer cable and connection is free from damage and that the connections are secure and free from corrosion.
Turbulence around the transducer at higher speeds may affect transducer performance	Slow vessel speed and recheck.
Interference from another transducer	<ol style="list-style-type: none"> Turn off the transducer causing the interference. Reposition the transducers so they are farther apart.
Unit power supply fault	Check the voltage from the power supply, if this is too low it can affect the transmitting power of the unit.

Note:

If you are experiencing issues with the fishfinder app scrolling image you can record a video file of the issue that can be sent to Raymarine technical support for analysis. For details refer to: [p.525 — Diagnostics sonar recording](#)

Sonar depth data recording/logging

The MFD includes features that will record or log your vessel's depth and position data.

Vessel depth and position logging features:

- **RealBathy™** — In the chart app when using LightHouse™ charts, the RealBathy™ feature logs vessel depth and position to enable creation of personalized depth contours that can be displayed in realtime. For details refer to: [p.221 — RealBathy™ depth contours](#)
- **SonarChart™ Live** — In the chart app, when using compatible Navionics charts, the SonarChart™ Live feature logs vessel depth and position to enable creation of personalized depth contours that can be displayed in realtime. For details refer to: [p.222 — SonarChart™ Live](#)
- **Data logging** — When the MFD is configured using the *First Responder* profile, vessel depth, vessel position, active MoB, and details of nearby AIS targets are logged to a CSV file and saved to a memory card. For details refer to: [p.364 — Data logging](#)
- **Sonar recording** — The sonar recording feature is for troubleshooting purposes only, and records the fishfinder app's scrolling image to a video file for analysis by Raymarine technical support. For details refer to: [p.525 — Diagnostics sonar recording](#)

All of the recording/logging features can be enabled and disabled as desired; for instructions, refer to the links provided above.

Diagnostics sonar recording

Sonar recording enables you to record the fishfinder scrolling image as a video file, for troubleshooting purposes only. This means that any issues encountered in the Fishfinder app can be recorded and provided to Raymarine technical support for analysis. The recorded file is saved to a memory card, but cannot be viewed in standard video player software.

Sonar recording is enabled from the *[Diagnostics]* options in the *[Network]* settings tab: *[Homescreen > Network > Diagnostics > Enable sonar recording]*.

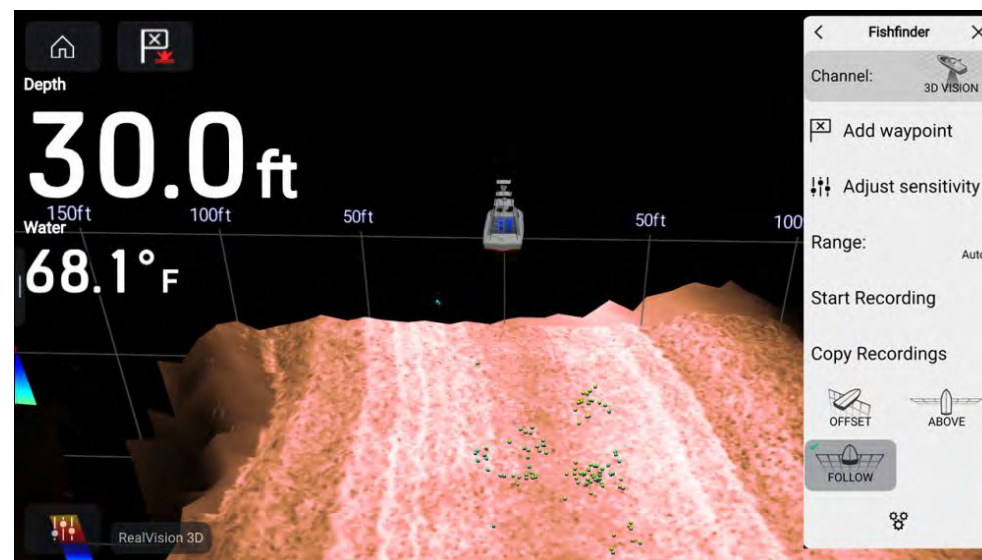
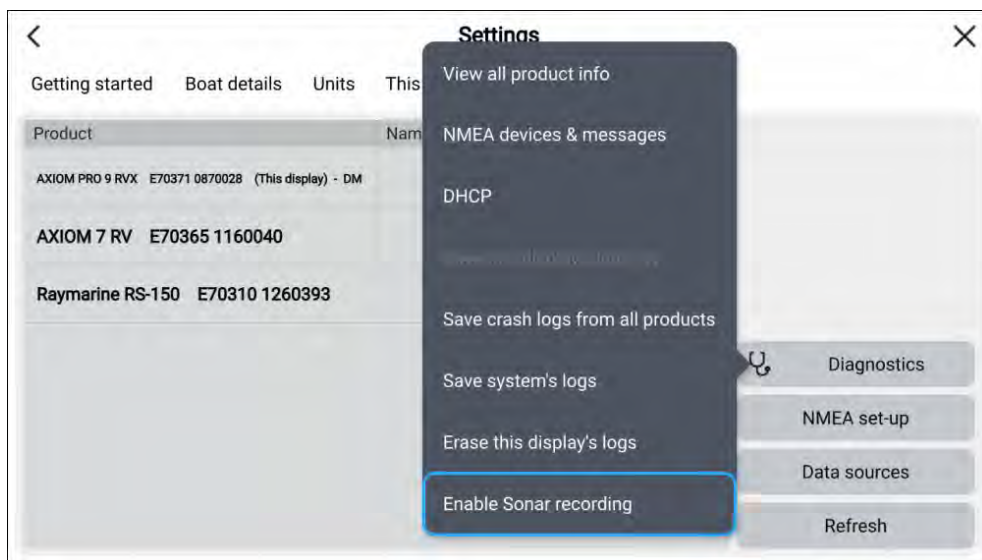

When sonar recording is enabled, the *[Start recording]*, *[Copy recording]*, and *[Stop recording]* options will be available in the fishfinder app's main menu. For more information, refer to: [Recording sonar for troubleshooting](#)

Sonar recording creates a .rec video file, which can be copied to a memory card and sent to technical support.

Recording sonar for troubleshooting

The fishfinder app scrolling image can be recorded and transferred to memory card so that it can be sent to Raymarine technical support for analysis. This feature is intended to be used for diagnostic purposes only.

1. Select *[Enable sonar recording]* from the Diagnostics menu: *[Homescreen > Network > Diagnostics > Enable sonar recording]*.
2. Insert a memory card into a card reader slot.
3. Open the fishfinder app.
4. Select *[Start recording]* from the main menu.
5. Select *[Stop recording]* from the main menu.
6. Select *[Copy recording]* from the main menu.
7. Select the relevant card reader slot.
8. Select *[Copy recording]*.

A .rec video file will now be saved to your memory card.

Note:

The recording options shown in the screenshot below are only available in the fishfinder app when the *[Enable sonar recording]* option is enabled in the Diagnostics menu. For more information, refer to: [Diagnostics sonar recording](#)

36.10 Camera troubleshooting

Video not displayed

Possible causes	Possible solutions
Incorrect power up sequence	Your MFD needs to be powered up before your camera to enable the MFD to provide the camera with a valid IP address.
Camera not compatible.	Ensure the camera feed and network settings are compatible: <ul style="list-style-type: none"> • Camera feed should be set to 720p max. • Network should be set to obtain network address automatically (DHCP). • Anonymous login should be enabled.
Too many IP feeds on network.	Displaying multiple feeds on multiple MFDs simultaneously may cause some feeds to not be displayed. Try viewing less feeds.
Problem with the camera connections.	<ol style="list-style-type: none"> 1. Check the unit's connector for broken or bent pins. 2. Check that the cable connector is fully inserted into the unit and that the locking collar is in the locked position. 3. Check the cable and connectors for signs of damage or corrosion, replace if necessary. 4. With the unit turned on, try flexing the power cable to see if this causes the unit to re-boot/loose power, replace if necessary.
Problem with power supply to the camera or thermal camera's JCU (if used as the primary controller)	<ul style="list-style-type: none"> • Check the power connections to the camera, JCU, and PoE injector (if used). • Ensure that the power switch / breaker is on. • Check the fuse / breaker state.
Camera is in Standby mode.	Use the camera controls (either the Camera app or a Thermal camera's JCU) to "wake" the camera from standby.

PTZ cameras — Erratic or unresponsive controls

Possible causes	Possible solutions
Network problem.	<ul style="list-style-type: none"> • Check that the controller and camera are correctly connected to the network. • If used, check the status of the network switch. • Check that RayNet cables are free from damage.
Control conflict, e.g. caused by multiple users at different stations.	Ensure that no other controllers are in use at the same time.
Problem with the controller.	<ul style="list-style-type: none"> • Check power / network cabling to the controller and PoE injector, if used. • Check other controllers, if available.

Cannot switch between camera feeds

Possible causes	Possible solutions
Camera is not a dual payload model.	Only "dual payload" (dual lens) cameras support feed switching.

Noisy image

Possible causes	Possible solutions
Poor quality or faulty cabling.	<ul style="list-style-type: none"> • Ensure cable runs are no longer than they need to be. • Use only high quality shielded cable suitable for the marine environment.
Cable is picking up electromagnetic interference (EMI) from another device.	<ul style="list-style-type: none"> • Ensure you are using a high quality shielded cable. • Ensure proper cable separation, for example do not run data and power cables in close proximity with each other. • In certain conditions it may be necessary to fit suppression ferrites to cabling to eliminate interference.

Image too dark or too light

Possible causes	Possible solutions
Brightness set too low.	Check MFD brightness and adjust if necessary.
The contrast and / or brightness settings in the Camera app are set too low.	Check Camera brightness and contrast, adjust if necessary.
The Scene Mode is not appropriate for the current conditions.	When viewing a thermal camera feed, a particular environment may benefit from using a different Scene Mode setting. For example, a very cold background (such as the sky) could cause the camera to use a wider temperature range than appropriate. Adjust the Scene as appropriate.

Image freezes momentarily

Possible causes	Possible solutions
FFC (Flat Field Correction).	A Thermal camera's image will pause momentarily on a periodic basis during the Flat Field Correction (FFC) cycle. Just prior to the FFC, a small green square may appear in the upper left corner of the screen.

Image is inverted (upside down or mirror image)

Possible causes	Possible solutions
Vertical or Horizontal flip control incorrectly set	Check the image flip controls to ensure they are set correctly for your installation.

36.11 Augmented Reality (AR) Troubleshooting

AR options not available in Video app

Possible causes	Possible solutions
Wrong camera selected.	Ensure that the correct AR-compatible camera has been selected in the Video app menu.
Compatible camera not detected.	<ol style="list-style-type: none"> 1. Ensure your camera is AR compatible. 2. Ensure your camera is correctly installed and networked to your MFD.
AR200 not detected.	Ensure your AR200 is correctly installed and on the same network as the MFD from which you are using the AR features.
Incorrect LightHouse™ software version.	Ensure that your MFD is running LightHouse™ 3 version 3.7 or above or LightHouse™ 4.
AR options turned off.	<p>The Compass bar, AIS, Waypoint and Chart object flags can be enabled and disabled from the <i>[ClearCruise]</i> settings page (<i>[Video app > Menu > Settings > ClearCruise]</i>). Ensure relevant options are enabled.</p> <hr/> <p>Note:</p> <p>For AIS flags to be displayed, compatible AIS hardware must be operational and connected to the same network as your MFD.</p>

AR flags do not appear directly above on-screen target

Possible causes	Possible solutions
AIS update rate	Depending on the classification of the target's AIS hardware, transmitted position updates may be sent up to 3 minutes apart and therefore the flag may appear up to 3 minutes behind the actual onscreen target.
Camera Field of View (FOV) set incorrectly.	Ensure that the FOV setting reflects your camera's horizontal FOV. Check your camera's documentation for FOV specifications.
AR200 interference	If your AR200 is installed in a location which includes a source of magnetic interference large enough to affect AR flag placement, you may need to re-install the AR200 in a different location.
Deviation too high	<ol style="list-style-type: none"> 1. Reset the AR200 calibration by selecting <i>[Reset]</i> from the AR200 calibration page: <i>[Homescreen > Settings > Network > Data sources > Heading > Raymarine AR200 Attitude > Calibrate]</i>. 2. If the problem persists, you may need to move your AR200 to a location with less magnetic interference.

36.12 Wi-Fi troubleshooting

Before troubleshooting problems with your Wi-Fi connection, ensure that you have followed the Wi-Fi location requirements guidance provided in the relevant installation instructions and performed a power cycle/reboot of the devices you are experiencing problems with.

Cannot find network

Possible cause	Possible solutions
Wi-Fi not currently enabled on devices.	Ensure Wi-Fi is enabled on both Wi-Fi devices and rescan available networks.
Some devices may automatically turn off Wi-Fi when not in use to save power.	Power cycle / reboot devices and rescan available networks.
Device not broadcasting.	<ol style="list-style-type: none">1. Try to enable broadcasting of the device's network using the Wi-Fi settings on the device you are trying to connect to.2. You may still be able to connect to the device, when it is not broadcasting, by manually entering the device's Wi-Fi Name / SSID and passphrase in the connection settings of the device you are trying to connect.
Devices out of range or signal being blocked.	Move devices closer together or, if possible remove the obstructions and then rescan available network.

Cannot connect to network

Possible cause	Possible solutions
Some devices may automatically turn off Wi-Fi when not in use to save power.	Power cycle/reboot devices and retry the connection.
Trying to connect to the wrong Wi-Fi network	Ensure you are trying to connect to the correct Wi-Fi network, the Wi-Fi network's name can be found in the Wi-Fi settings on the broadcasting device (the device that you are trying to connect to).

Possible cause	Possible solutions
Incorrect network credentials	Ensure you are using the correct passphrase, the Wi-Fi network's passphrase can be found in the Wi-Fi settings on the broadcasting device (the device that you are trying to connect to).
Bulkheads, decks and other heavy structure can degrade and even block the Wi-Fi signal. Depending on the thickness and material used it may not always be possible to pass a Wi-Fi signal through certain structures	<ol style="list-style-type: none">1. Try repositioning the devices so the structure is removed from the direct line of sight between the devices, or2. If possible use a wired connection instead.
Interference being caused by other Wi-Fi enabled or older Bluetooth enabled devices (Bluetooth and Wi-Fi both operate in the 2.4 GHz frequency range, some older bluetooth devices may interfere with Wi-Fi signals.)	<ol style="list-style-type: none">1. Change the Wi-Fi Channel of the device you are trying to connect to and retry the connection. You can use free Wi-Fi analyzer apps on your smart device to help you choose a better channel (channel with least traffic).2. Temporarily disable each wireless device in turn until you have identified the device causing the interference.

Possible cause	Possible solutions
<p>Interference caused by other devices that use the 2.4GHz frequency See list below of some common devices that use the 2.4GHz frequency:</p> <ul style="list-style-type: none"> • Microwave ovens • Fluorescent lighting • Cordless phones / baby monitors • Motion sensors 	<p>Temporarily switch off each device in turn until you have identified the device causing the interference, then remove or reposition the offending device(s).</p>
<p>Interference caused by electrical and electronic devices and associated cabling could generate an electromagnetic field which may interfere with the Wi-Fi signal.</p>	<p>Temporarily switch off each item in turn until you have identified the device causing the interference, then remove or reposition the offending device(s).</p>

Connection extremely slow and or keeps dropping out

Possible cause	Possible solutions
<p>Wi-Fi performance degrades over distance so products farther away will receive less network bandwidth. Products installed close to their maximum Wi-Fi range will experience slow connection speeds, signal drop outs or not being able to connect at all.</p>	<ul style="list-style-type: none"> • Move devices closer together. • For fixed installations such as a Quantum Radar, enable the Wi-Fi connection on an display installed closer to the device.
<p>Interference being caused by other Wi-Fi enabled or older Bluetooth enabled devices (Bluetooth and Wi-Fi both operate in the 2.4 GHz frequency range, some older bluetooth devices may interfere with Wi-Fi signals.)</p>	<ol style="list-style-type: none"> 1. Change the Wi-Fi Channel of the device you are trying to connect to and retry the connection. You can use free Wi-Fi analyzer apps on your smart device to help you choose a better channel (channel with least traffic). 2. Temporarily switch off each device in turn until you have identified the device causing the interference, then remove or reposition the offending device(s).
<p>Interference from devices on other vessels. When in close proximity to other vessels, for example, when moored up in a marina, many other Wi-Fi signals may be present.</p>	<ol style="list-style-type: none"> 1. Change the Wi-Fi Channel of the device you are trying to connect to and retry the connection. You can use free Wi-Fi analyzer apps on your smart device to help you choose a better channel (channel with least traffic). 2. If possible, move your vessel to a location with less Wi-Fi traffic.

Network connection established but no data

Possible cause	Possible solutions
Connected to the wrong network.	Ensure that your devices is connected to the correct network.
Device software incompatibility.	Ensure both devices are running the latest available software.
It may be possible that the device has become defective.	<ol style="list-style-type: none"> 1. Try updating software to a later version, or 2. try reinstalling the software. 3. Obtain new replacement device.

Mobile application running slowly or not at all

Possible cause	Possible solutions
Raymarine® app not installed	Install mobile app from relevant app store.
Raymarine® app version not compatible with display software	Ensure mobile app and display software are latest available versions.
Mobile apps not enabled on display	Enable “Viewing only” or “Remote Control” as required in the Mobile Apps setting on your display.

36.13 IP address conflict troubleshooting

Under normal circumstances in a Raymarine® system the data master display or a YachtSense™ Link router will act as a DHCP server and assign unique IP addresses to all connected network devices during power up. Under certain

circumstances an IP address conflict can occur. An IP address conflict means that more than 1 device on the network has been assigned the same IP address. Possible causes and solutions are shown below.

Possible cause	Possible solutions
There is more than one device on the network acting as a DHCP server.	<ul style="list-style-type: none"> • Disable the DHCP server on devices where it is not required. • Where multiple DHCP servers are required, ensure that there is no cross over in the ranges they are assigning.
One or more devices have been assigned a static IP address.	<ul style="list-style-type: none"> • Change devices with a static IP address to Dynamic so that it is assigned a unique address by the DHCP server. • If a static address is required, ensure it is outside of the range of addresses which can be assigned by the DHCP server.
YachtSense Link router software update.	<p>From router software version 4.20 and above display’s can no longer be connected to the router using a Wi-Fi connection.</p> <ul style="list-style-type: none"> • If your display has previously been connect using a Wi-Fi connection but also has a RayNet wired connection then you will need to ‘Forget’ the Wi-Fi network connection.
Third party DHCP server incorrectly configured or incompatible.	<ul style="list-style-type: none"> • If using a third party DHCP server, for guidance on correct configuration refer to: p.550 – Ethernet (IPv4) networking of Raymarine devices with third-party products

36.14 Wireless display troubleshooting

Cannot connect to wireless display

Possible cause	Possible solutions
Some Miracast compatible but non certified devices may not be able to connect with Wi-Fi Sharing enabled.	Disable Wi-Fi Sharing on your MFD and retry connection.
Wi-Fi Sharing has been enabled or disabled since the wireless display was first connected.	Try power cycling devices and trying again. Depending on dongle used a factory reset may be required to establish a connection.
Missed confirmation on wireless display	Restart connection procedure and ensure you check the wireless display for confirmation dialogs.
Wireless display too far away	Try moving the wireless display closer to the MFD and retry connection.
Chromecast devices are not supported.	Purchase a Miracast compatible device.

Poor performance

Possible cause	Possible solutions
High video processing demand.	The Camera app, Raymarine mobile app connections can interfere with the wireless display performance as they use shared video processing resource. Try switching off video feeds and/or mobile app connections.
Wireless display too far away	Try moving the wireless display closer to the MFD and retry connection.

Wireless display disconnects

Possible cause	Possible solutions
Changing the Wi-Fi Sharing option on your MFD will cause the wireless display to disconnect.	Do not change Wi-Fi sharing options whilst connected to a wireless display. Wireless display may require factory reset to re-establish connection.
Quantum wireless pairing process will cause wireless display to disconnect.	Do not pair with a Quantum Radar whilst wireless display connection is active.
Wireless display too far away	Try moving the wireless display closer to the MFD and retry connection.

36.15 Data troubleshooting

Instrument, engine or other system data is unavailable at all displays

Possible causes	Possible solutions
Data is not being received at the display(s).	<ul style="list-style-type: none"> Check transmitted data is compatible with your display. Refer to MFD supported PGN list. Check the data bus (e.g. SeaTalk^{ng}) wiring and connections.
Data source (e.g. instrument display or engine interface) is not operating.	<ul style="list-style-type: none"> Check the source of the missing data (e.g. instrument display or engine interface). Check power to the data bus.
Software mismatch between equipment may prevent communication.	<ul style="list-style-type: none"> Check the Raymarine website and ensure all your Raymarine products have the latest software.

Instrument or other system data is missing from some but not all displays

Possible causes	Possible solutions
Network connection problem.	<ul style="list-style-type: none">• Check that all required equipment is connected to the same network.• Check correct operation of network switch, if used.• Check network cabling is correct and free from damage.
Software mismatch between equipment may prevent communication.	Check all MFDs are using the same version of software.

36.16 Touchscreen troubleshooting

Touchscreen does not operate as expected.

Possible causes	Possible solutions
Touch lock is enabled.	Disable TouchLock, using the power button..
Screen is not being operated with bare fingers, for example gloves are being worn.	Bare fingers must make contact with the screen for correct operation. Alternatively you may use conductive gloves.
Saltwater deposits on the screen.	Carefully clean and dry the screen with a damp non-abrasive cloth.

CHAPTER 37: TECHNICAL SUPPORT

CHAPTER CONTENTS

- 37.1 Raymarine technical support and servicing — page 536
- 37.2 Learning resources — page 538

37.1 Raymarine technical support and servicing

Raymarine provides a comprehensive technical support service, as well as warranty, service, and repairs. You can access these services through the Raymarine website, telephone, and e-mail.

Product information

If you need to request service or support, please have the following information to hand:

- Product name.
- Product identity.
- Serial number.
- Software application version.
- System diagrams.

You can obtain this product information using diagnostic pages of the connected display.

Servicing and warranty

Raymarine offers dedicated service departments for warranty, service, and repairs.

Don't forget to visit the Raymarine website to register your product for extended warranty benefits: <https://www.raymarine.com/en-us/support/product-registration>

United Kingdom (UK), EMEA, and Asia Pacific:

- E-Mail: emea.service@raymarine.com
- Tel: +44 (0)1329 246 932

United States (US):

- E-Mail: rm-usrepair@flir.com
- Tel: +1 (603) 324 7900

Web support

Please visit the "Support" area of the Raymarine website for:

- **Manuals and Documents** — <http://www.raymarine.com/manuals>
- **Technical support forum** — <https://raymarine.custhelp.com/app/home>
- **Software updates** — <http://www.raymarine.com/software>

Worldwide support

United Kingdom (UK), EMEA, and Asia Pacific:

- Help desk: <https://raymarine.custhelp.com/app/home>
- Tel: +44 (0)1329 246 777

United States (US):

- Help desk: <https://raymarine.custhelp.com/app/home>
- Tel: +1 (603) 324 7900 (Toll-free: +800 539 5539)

Australia and New Zealand (Raymarine subsidiary):

- E-Mail: aus.support@raymarine.com
- Tel: +61 2 8977 0300

France (Raymarine subsidiary):

- E-Mail: support.fr@raymarine.com
- Tel: +33 (0)1 46 49 72 30

Germany (Raymarine subsidiary):

- E-Mail: support.de@raymarine.com
- Tel: +49 40 237 808 0

Italy (Raymarine subsidiary):

- E-Mail: support.it@raymarine.com
- Tel: +39 02 9945 1001

Spain (Authorized Raymarine distributor):

- E-Mail: sat@azimut.es
- Tel: +34 96 2965 102

Netherlands (Raymarine subsidiary):

- E-Mail: support.nl@raymarine.com
- Tel: +31 (0)26 3614 905

Sweden (Raymarine subsidiary):

- E-Mail: support.se@raymarine.com
- Tel: +46 (0)317 633 670

Finland (Raymarine subsidiary):

- E-Mail: support.fi@raymarine.com
- Tel: +358 (0)207 619 937

Norway (Raymarine subsidiary):

- E-Mail: support.no@raymarine.com
- Tel: +47 692 64 600

Denmark (Raymarine subsidiary):

- E-Mail: support.dk@raymarine.com
- Tel: +45 437 164 64

Russia (Authorized Raymarine distributor):

- E-Mail: info@mikstmarine.ru
- Tel: +7 495 788 0508

Viewing product information

Use the *[Settings]* menu to view hardware and software information about your display, and connected products.

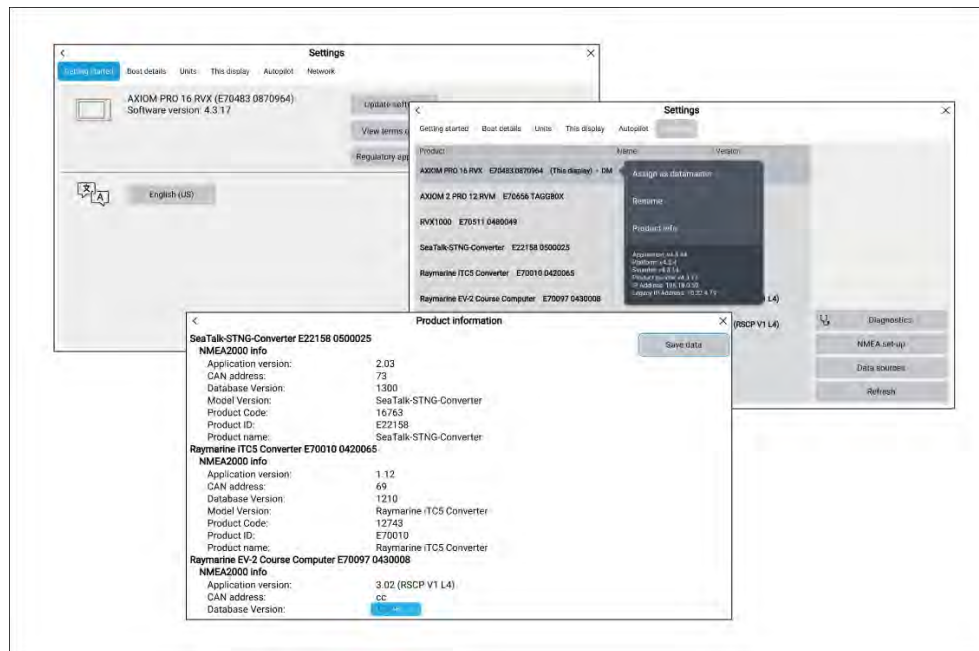

1. Select *[Settings]*, from the Homescreen.
The *[Getting started]* menu contains hardware and software information for your display.

2. You can view further information about your display, or view information about products networked using SeaTalk HS and SeaTalk NG / NMEA 2000, by selecting the *[Network]* tab, then:
 - i. to display detailed software information and your display's network IP address, select your display from the list.
 - ii. to display detailed diagnostics information for all products, select *[Product info]* from the *[Diagnostics]* pop over menu.

Remote Support via AnyDesk

The AnyDesk remote desktop app is available on your Raymarine multifunction display from the app launcher: *[Homescreen > Apps]*.

The AnyDesk app enables a Raymarine Product Support representative to remotely connect to and control your MFD over an Internet connection, for the purposes of technical support and troubleshooting.

To get started, you will first need to contact Raymarine Product Support. If the representative considers that your support case would benefit from a remote session, you need to first ensure that your MFD has an active Internet connection via Wi-Fi. Next, launch the AnyDesk app from your MFD's homescreen, and then provide the displayed unique ID to the Raymarine Product Support representative. Then follow any further instructions provided to you by the representative.

Attention

- **AnyDesk is provided for troubleshooting and support purposes only, and is NOT intended to perform remote functions on your vessel. Raymarine will NOT be held liable for damage or injury to equipment or persons caused by the use of a remote connection to your MFD.**
- **Do not disclose your AnyDesk ID to anyone other than authorised Raymarine Product Support personnel.**
- **Do not use the AnyDesk app to remotely activate connected devices such as Autopilot, Radar or Sonar hardware.**

37.2 Learning resources

Raymarine has produced a range of learning resources to help you get the most out of your products.

Video tutorials

Raymarine official channel on YouTube

- <http://www.youtube.com/user/RaymarineInc>

Training courses

Raymarine regularly runs a range of in-depth training courses to help you make the most of your products. Visit the Training section of the Raymarine website for more information:

- <http://www.raymarine.co.uk/view/?id=2372>

Technical support forum

You can use the Technical support forum to ask a technical question about a Raymarine product or to find out how other customers are using their Raymarine equipment. The resource is regularly updated with contributions from Raymarine customers and staff:

- <https://raymarine.custhelp.com/app/home>

Appendix A NMEA 0183 sentence support

Note:

- Axiom® Pro and Axiom® XL displays support direct NMEA 0183 connections.
- Axiom®, Axiom@+, Axiom® 2 Pro and Axiom® 2 XL displays do NOT support direct NMEA 0183 connections.

Supported sentences:

- **AAM** — Waypoint Arrival Alarm (Receive / Transmit)
- **ALR** — Set Alarm State (Receive)
- **APB** — Autopilot B Sentence (Receive / Transmit)
- **BWC** — Bearing & Distance to Waypoint — Great Circle (Receive / Transmit)
- **BWR** — Bearing & Distance to Waypoint — Rhumb Line (Receive / Transmit)
- **DBT** — Depth Below Transducer (Receive / Transmit)
- **DPT** — Depth (Receive / Transmit)
- **DSC** — Digital Selective Calling Information (Receive)
- **DSE** — Extended DSC (Receive)
- **DTM** — Datum Reference (Receive / Transmit)
- **GBS** — GPS Satellite Fault Detection (Receive / Transmit)
- **GGA** — Global Positioning System Fix Data (Receive / Transmit)
- **GLL** — Geographic Position — Latitude / Longitude (Receive / Transmit)
- **GLC** — Geographic Position — Loran-C (Receive / Transmit)
- **GSA** — GPS DOP & Active Satellites (Receive / Transmit)
- **GST** — GPS Pseudorange Error Statistic (Receive / Transmit)
- **GSV** — GPS Satellites in View (Receive / Transmit)
- **HDG** — Heading — Deviation & Variation (Receive / Transmit)
- **HDM** — Heading — Magnetic (Receive / Transmit)
- **HDT** — Heading — True (Receive / Transmit)
- **MDA** — Meteorological Composite (Receive / Transmit)
- **MSK** — Control for a Beacon Receiver (Receive / Transmit)
- **MSS** — Beacon Receiver Status (Receive / Transmit)
- **MTW** — Mean Temperature of Water (Receive / Transmit)
- **MWV** — Wind Speed and Angle (Receive / Transmit)
- **RMA** — Recommended Minimum Navigation Information — Loran-C Data (Receive / Transmit)
- **RMB** — Recommended Minimum Navigation Information — GPS Data (Receive / Transmit)
- **RMC** — Recommended Minimum Navigation Information — Specific GPS Data (Receive / Transmit)
- **RTE** — Routes (Receive / Transmit)
- **RSD** — Radar System Data (Receive / Transmit)
- **SSD** — AIS Ship Static Data (Receive)
- **THS** — True Heading and Status (Receive / Transmit)
- **TTM** — Tracked Target Message (Receive / Transmit)
- **VDM** — AIS VHF Data-link Message (Receive)
- **VDO** — AIS VHF Data-link Own-Vessel Report (Receive)
- **VHW** — Water Speed and Heading (Receive / Transmit)
- **VLW** — Distance Travelled Through Water (Receive / Transmit)
- **VTG** — Course Over ground & Ground Speed (Receive / Transmit)
- **VSD** — AIS Voyage Static Data (Receive)
- **WPL** — Waypoint Location (Receive / Transmit)
- **XTE** — Measured Cross Track Error (Receive / Transmit)
- **ZDA** — Time & date (Receive / Transmit)

Appendix B NMEA 2000 PGN support

Supported standard NMEA 2000 PGNs are listed below. Raymarine and other proprietary PGNs are not listed.

Note:

Support for some PGNs may be restricted to a specific application.

Administration PGNs

- **59392** — ISO Acknowledge (Receive / Transmit)
- **59904** — ISO Request (Receive / Transmit)
- **60160** — ISO Transport Protocol, Data Transfer (Receive)
- **60416** — ISO Transport Protocol, Connection Management — BAM Group Function (Receive)
- **60928** — ISO Address Claim (Receive / Transmit)
- **65240** — ISO Commanded address (Receive)
- **126208** — NMEA — Request, Commanded, Acknowledged Group Function (Receive / Transmit)
- **126464** — PGN Transmit and Receive List (Receive / Transmit)
- **126996** — Product Information (Receive / Transmit)
- **126998** — Configuration Information (Receive / Transmit)

Data PGNs

- **126983** — Alert (Receive)
- **126984** — Alert Response (Transmit)
- **126985** — Alert Text (Receive)
- **126986** — Alert Configuration (Receive)
- **126992** — System Time (Receive / Transmit)
- **126993** — Heartbeat (Receive / Transmit)
- **127237** — Heading/Track Control (Receive) (Transmit is available in the First responder profile)
- **127245** — Rudder (Receive)
- **127250** — Vessel Heading (Receive / Transmit)
- **127251** — Rate of Turn (Receive / Transmit)

- **127257** — Attitude (Receive / Transmit)
- **127258** — Magnetic Variation (Transmit)
- **127488** — Engine Parameters, Rapid Update (Receive)
- **127489** — Engine Parameters, Dynamic (Receive)
- **127493** — Transmission Parameters, Dynamic (Receive)
- **127496** — Trip Parameters, Vessel (Receive)
- **127497** — Trip Parameters, Engine (Receive)
- **127498** — Engine Parameters, Static (Receive)
- **127503** — AC input status (Receive)
- **127504** — AC output status (Receive)
- **127505** — Fluid Level (Receive)
- **127506** — DC detailed status (Receive)
- **127507** — Charger status (Receive)
- **127508** — Battery status (Receive)
- **127509** — Inverter status (Receive)
- **127510** — Charger configuration status (Receive)
- **127511** — Inverter configuration status (Receive)
- **127512** — AGS configuration status (Receive)
- **127513** — Battery configuration status (Receive)
- **127514** — AGS Status (Receive)
- **127744** — AC Power / Current-Phase A (Receive)
- **127745** — AC Power / Current-Phase B (Receive)
- **127746** — AC Power / Current-Phase C (Receive)
- **127747** — AC Voltage / Frequency-Phase A (Receive)
- **127748** — AC Voltage / Frequency-Phase B (Receive)
- **127749** — AC Voltage / Frequency-Phase C (Receive)
- **127750** — Converter (Inverter/Charger) Status (Receive)
- **127751** — DC Voltage / Current (Receive)
- **128259** — Speed, (Receive / Transmit)
- **128267** — Water Depth (Receive / Transmit)
- **128275** — Distance Log (Receive / Transmit)

- **128780** — Linear Actuator Control/Status (receive)
- **129025** — Position, Rapid Update (Receive / Transmit)
- **129026** — COG & SOG, Rapid Update (Receive / Transmit)
- **129029** — GNSS Position Data (Receive / Transmit)
- **129033** — Time & Date (Receive / Transmit)
- **129038** — AIS Class A Position Report (Receive) (Transmit is available in the First responder profile)
- **129039** — AIS Class B Position Report (Receive)
- **129040** — AIS Class B Extended Position Report (Receive)
- **129041** — AIS Aids to Navigation (AtoN) Report (Receive)
- **129044** — Datum (Receive / Transmit)
- **129283** — Cross Track Error (Receive / Transmit)
- **129284** — Navigation Data (Receive / Transmit)
- **129285** — Navigation — Route / WP Information (Transmit)
- **129291** — Set & Drift, Rapid Update (Receive / Transmit)
- **129301** — Time to/from Mark (Receive)
- **129539** — GNSS DOPs (Receive / Transmit)
- **129540** — GNSS Sats in View (Receive / Transmit)
- **129542** — GNSS Pseudorange Noise Statistics (Receive)
- **129545** — GNSS RAIM Output (Receive)
- **129547** — GNSS Pseudorange Error Statistics (Receive)
- **129550** — GNSS Differential Correction Receiver Interface (Receive)
- **129551** — GNSS Differential Correction Receiver Signal (Receive)
- **129793** — AIS UTC and Date Report (Receive)
- **129794** — AIS Class A Static and Voyage Related Data (Receive) (Transmit is available in the First responder profile)
- **129798** — AIS SAR Aircraft Position Report (Receive)
- **129801** — AIS Addressed Safety Related Message (Receive)
- **129802** — AIS Safety Related Broadcast Message (Receive)
- **129808** — DSC call information (Receive)
- **129809** — AIS Class B "CS" Static Report, Part A (Receive)
- **129810** — AIS Class B "CS" Static Report, Part B (Receive)
- **129811** — AIS Single Slot Binary Message (Receive / Transmit)
- **129812** — AIS Multi Slot Binary Message (Receive / Transmit)
- **130064** — Route and WP Service — Database List (Receive / Transmit)
- **130065** — Route and WP Service — Route List (Receive / Transmit)
- **130066** — Route and WP Service — Route/WP List Attributes (Receive / Transmit)
- **130067** — Route and WP Service — Route/WP Name & Position (Receive / Transmit)
- **130068** — Route and WP Service — Route/WP Name (Receive / Transmit)
- **130069** — Route and WP Service — XTE Limit & Navigation Method (Receive / Transmit)
- **130070** — Route and WP Service — WP Comment (Receive / Transmit)
- **130072** — Route and WP Service — Database Comment (Receive / Transmit)
- **130074** — Route and WP Service — WP List — WP Name & Position (Receive / Transmit)
- **130306** — Wind Data (Receive / Transmit)
- **130310** — Environmental Parameters (Receive / Transmit)
- **130311** — Environmental Parameters (Receive) (Transmit is available in the First responder profile)
- **130312** — Temperature (Receive) (Transmit is available in the First responder profile)
- **130313** — Humidity (Receive)
- **130314** — Actual pressure (Receive)
- **130316** — Temperature, Extended Range (Receive)
- **130569** — Entertainment — Current File and Status (Receive)
- **130570** — Entertainment — Library Data File (Receive)
- **130571** — Entertainment — Library Data Group (Receive)
- **130572** — Entertainment — Library Data Search (Receive)
- **130573** — Entertainment — Supported Source Data (Receive)
- **130574** — Entertainment — Supported Zone Data (Receive)
- **130576** — Small Craft Status (Receive)
- **130577** — Direction Data (Receive / Transmit)

- **130578** — Vessel Speed Components (Receive)
- **130579** — Entertainment — System Configuration (Receive)
- **130580** — Entertainment — System Configuration Status (Receive)
- **130586** — Entertainment — Zone Configuration Status (Receive)
- **130582** — Entertainment — Zone Volume (Receive)

Raymarine® provides field programmability of the Device and System Instances within PGN 60928 which can be commanded via use of PGN 126208 as required by the latest *[NMEA 2000]* standard.

Appendix C LightHouse 4 software release history

The list below is a cumulative list of the new features introduced in subsequent releases of the LightHouse 4 software, since the initial release (v4.0.70; April 2022).

This list includes *new features* only. It does NOT include software maintenance items, such as bug fixes or performance improvements.

To download the software, and view the complete list of all software updates, including new features, bug fixes, and performance improvements, visit:

LightHouse 4 software download link

<https://www.raymarine.com/en-us/download/lighthouse-4-update-for-axiom-chartplotters>

LightHouse 4 v4.5.84 New features

(Software release date: *September 2023*)

- Added support for Rhodan trolling motors. For details refer to: [p.147 — Trolling motor control](#)
- Added Avikus NeuBoat Dock app, for controlling an Avikus NeuBoat Docking system. For details refer to the separate operation instructions document number: 81418.
- Added support for NMEA 2000 Entertainment PGN 130579.
- Added ability to download software from the internet using a wired ethernet network connection. For details refer to: [p.37 — Updating software over the internet](#)
- Improved network connectivity with YachtSense™ Link router.
- Added support for RNS-8 PoE network switch diagnostics. For details refer to: [p.516 — RNS-8 Diagnostic information](#)
- Added Radar context menu drag feature. For details refer to: [Dragging the context menu](#)
- Added new data response settings to Dashboard app. For details refer to: [p.411 — Data response settings](#)
- Added NMEA 0183 diagnostics menu: For details refer to: [p.517 — NMEA 0183 diagnostics](#)
- LightHouse chart store updated to allow direct purchase. For details refer to: [p.492 — LightHouse charts](#)

- Automatic STW calibration (DST810). For details refer to: [p.75 — Automatic STW calibration \(DST810\)](#)
- Sonar improvements to help reduce No transducer found errors.

LightHouse 4 v4.4.87 New features

(Software release date: *March 2023*)

- New Homescreen icon style. For details, refer to: [p.89 — Homescreen app page icons](#)
- Added new automatic turning to next waypoint, while following a route. For details, refer to: [p.215 — Automatic turning](#)
- New Stop Nav button in top right of Chart app. For details, refer to: [p.192 — Chart app onscreen controls](#)
- Added ability to change the size of the zoom box in Fishfinder zoom mode. For details, refer to: [p.316 — Zoom mode](#)
- New 50:50 split view for Fishfinder zoom mode. For details, refer to: [p.317 — Zoom mode view](#)
- Updated Tune frequency control to enable frequency selection in kHz for single frequency channels. For details, refer to: [p.319 — Frequency tuning](#)
- Added support for displaying Fischer Panda NMEA 2000 generator data. For details, refer to: [p.404 — Generators page](#)
- Changed the location where image files are stored: For details, refer to: [p.79 — Taking a screenshot](#)
- VesselView app renamed Mercury app. For details, refer to: [p.413 — Mercury app](#)
- Sailing polar database updated, with 70 new polars added. For details, refer to: [p.289 — Polar laylines](#)
- Fishfinder bottom tracking and intensity improvements for CP370, CP470, and CP570 sonar modules.
- Fishfinder gain changes now apply to historical 'scroll back' for CP370, CP470, and CP570 sonar modules. To benefit from these improvements, ensure that your CPx70 sonar module is using the latest available CPx70 software.

LightHouse 4 v4.3.54 New features

(Software release date: *January 2023*)

- Added support for Axiom 2 Pro displays:

- Axiom 2 Pro lower keypad selection on initial start up. For details, refer to: [p.65 — Axiom® 2 Pro keypad type selection](#)
- Up to 3 user-configurable keys are available on Axiom 2 Pro. For details, refer to: [p.70 — Assigning a function to the user configurable key](#)
- Axiom 2 Pro displays include an Ambient Light Sensor. For details, refer to: [p.81 — Auto brightness](#)
- Axiom 2 Pro displays include audio controls. For details, refer to: [p.80 — Audio volume control](#)
- Added new *keep network alive* option: For details, refer to: [p.111 — Homescreen settings menus](#)
- Axiom 2 Pro displays include a pilot keypad status LED. For details, refer to: [p.143 — Pilot keypad LED status \(Axiom® 2 Pro only\)](#)
- Added support for CAM300 cameras, including image flip controls: For details, refer to: [p.443 — Image flip and mirroring](#)
- New Fishfinder color palettes for RVM transducers: For details, refer to: [p.320 — RealVision™ sonar display settings](#)

LightHouse 4 v4.3.42 New features

(Software release date: *December 2022*)

- Mercury integration features:
 - Added support for Mercury VesselView autopilot control (Autoheading and Active route). For details, refer to: [p.420 — Autopilot control](#)
 - Added support for Mercury VesselView Active Trim set up and control. For details, refer to: [p.423 — Active Trim](#)
 - Added support for Mercury VesselView primary display. For details, refer to: [p.417 — Mercury SmartCraft helm grouping](#)
- New rudder bar indicator in Chart app: For details, refer to: [p.218 — Rudder bar indicator](#)
- Added ability to enable Galileo satellite constellation. For details, refer to: [p.99 — GNSS settings](#)

LightHouse 4 v4.1.140 New features

(Software release date: *October 2022*)

- Mercury VesselView features:
 - Cruise control. For details, refer to: [p.425 — Cruise control](#)
 - Troll control. For details, refer to: [p.424 — Troll control](#)

- Switch steering angle indicator and alternator voltage. For details, refer to: [p.426 — Steering angle indicator](#)

New hybrid chart engine for improved performance for LightHouse charts.

- New automatic detection of batteries on NMEA 2000 network, and new battery configuration table and options. For details, refer to: [p.114 — Battery configuration](#)
- New fish type waypoint symbols added. For details refer to: [p.158 — Waypoint symbols](#)
- Added support for the YachtSense™ Link router: [p.103 — YachtSense™ Link](#)
- Added ability to sync MFD with the Raymarine app version 2.0: [p.104 — My data](#)
- Sailing polar database updated with 60 new boat models.
- Internal GNSS (GPS) receiver performance improvements for Axiom+, Axiom Pro and Axiom XL MFDs.

LightHouse 4 v4.0.85 New features

(Software release date: *August 2022*)

New features:

- Mercury VesselView features:
 - Support for new VesselView Sport Exhaust mode. For details, refer to: [p.426 — Sport exhaust](#)
 - New VesselView steering angle indicator. For details, refer to: [p.426 — Steering angle indicator](#)
 - New VesselView On Board Diagnostics (OBD) indicator. For details, refer to: [p.428 — On Board Diagnostics \(OBD\)](#)
 - New VesselView advanced engine data page. For details, refer to: [p.426 — Engine data page](#)
- Sirius Fish Mapping:
 - New Fish mapping chart mode available on SR200 receivers. For details, refer to: [p.255 — Fishing chart mode](#)
 - Fish mapping and weather layers available in Fishing chart mode. For details, refer to: [p.255 — Fishing intel menu](#)
- Sirius Weather features:
 - New Sea Surface Temperature (SST) transparency control. For details, refer to: [p.268 — Sea surface temperature and Surface pressure layers](#)

- New 10 nm range for weather watchbox. For details, refer to: [p.272 – Weather settings menu](#)
- New legend in weather mode. For details, refer to: [p.263 – Weather mode main menu](#)
- Homescreen
 - Support for custom user background images for the startup screen (splashscreen) and homescreen. For details, refer to: [p.119 – Splashscreen and background images](#)
 - Data widget (Dynamic tiles). For details, refer to: [p.96 – Homescreen Dynamic tile](#)
- Chart app
 - Added support for Imray electronic charts. For details, refer to: [Third-party raster charts](#)
 - New route highlighting feature. For details, refer to: [p.160 – Route highlighting](#)
 - Added ability to view historical Navionics SonarChart Live in chart app. For details, refer to: [p.247 – Depth settings menu](#)
 - Added Relief shading and SonarChart shading options to Navionics overlays. For details, refer to: [p.244 – Layers settings menu](#)
 - Added ability to use Speed Over Ground (SOG) instead of Speed Through Water (STW) for heading vector: For details, refer to: [p.199 – Vessel details](#)
- Fish detection algorithm improved to support CP100, CP370, CP470 and CP570 sonar modules. For details, refer to: [p.317 – Fish detection](#)
- Added support for multi-zone volume controls for compatible JL Audio and Rockford Fosgate entertainment systems: For details, refer to: [p.484 – Adjusting multi-zone controls](#)
- Spotify app will be removed when a factory reset is performed. For details, refer to: [p.33 – Spotify app removal](#)
- Radar [*Target expansion*] setting has been renamed to [*Expanded returns*]. See: [p.356 – Preferences settings menu](#)

Appendix D Peripheral product software compatibility

The tables below identify the minimum software versions required for peripheral Raymarine products to maintain compatibility with the latest features and improvements in the LightHouse 4 operating system.

Note:

It is recommended that you always update devices to the latest available versions.

LightHouse 4 v4.6.42 / v4.6.103

Product	New software version
• RVX1000 (E70511) sonar module	v4.6.103
• RVM1600 (E70665) sonar module	
• RS150 (E70310) GNSS (GPS) Receiver	v1.29 (Required for LED <i>[Off]</i> and <i>[Find me]</i> settings.)
• AR200 (E70537) Augmented reality GNSS (GPS) and heading sensor.	v1.33 (Required for LED <i>[Off]</i> and <i>[Find me]</i> settings.)
• EV-1 (E70096) Sensor core	v3.17 (Required for LED <i>[Off]</i> and <i>[Find me]</i> settings.)
• EV-2 (E70097) Sensor core	v3.17 (Required for LED <i>[Off]</i> and <i>[Find me]</i> settings.)
• p70 (E22166) / p70s (E70328) pilot controllers	v3.13 (Required to support MFD Wind vane mode.)
• p70R (E22167) / p70Rs (E70329) pilot controllers	
• RMK9 (A80217) keypad	v20.0.17
• RMK10 (T70293) keypad	

LightHouse 4 v4.5.84

Product	Minimum software version
• Alpha 7 performance display (E70649)	v1.0.77
• Alpha 9 performance display (E70650)	
• RSW Wired wind transducer	First release
• RVX1000 (E70511) sonar module	v4.5.84
• RVM1600 (E70665) sonar module	

LightHouse 4 v4.4.87

Product	Minimum software version
• RVX1000 (E70511) sonar module	v4.4.87
• RVM1600 (E70665) sonar module	

LightHouse 4 v4.4.70

Product	Minimum software version
• RVX1000 (E70511) sonar module	v4.4.70
• RVM1600 (E70665) sonar module	
• CP470 (E70298) sonar module	v22.0.15
• CP570 (E70258) sonar module	
• p70 (E22166) / p70s (E70328) pilot controllers	v3.12
• p70R (E22167) / p70Rs (E70329) pilot controllers	
• Evolution™ autopilots EV-1 (E70096) sensor	v3.14
• Evolution™ autopilots EV-2 (E70097) sensor	v3.14

Product	Minimum software version
• SeaTalkng® auxiliary alarm buzzer (A80614)	v1.06
• RMK9 (A80217) keypad	v20.0.16
• RMK10 (T70293) keypad	

LightHouse 4 v4.3.54

Product	Minimum software version
• RMK9 (A80217) keypad	v20.0.15
• RMK10 (T70293) keypad	
• RVX1000 (E70511) sonar module	v4.3.54
• RVM1600 (E70665) sonar module	

LightHouse 4 v4.1.140

Product	Minimum software version
• RMK9 (A80217) keypad	v20.0.15
• RMK10 (T70293) keypad	
• RVX1000 (E70511) sonar module	v4.1.140

LightHouse 4 v4.0.85

Product	Minimum software version
• RMK9 (A80217) keypad	v20.0.8
• RMK10 (T70293) keypad	
• RVX1000 (E70511) sonar module	v4.0.85
• CP100 (E70204) sonar module	v21.0.04
• CP200 (E70256) sonar module	
• CP370 (E70297) sonar module	
• CP470 (E70298) sonar module	
• CP570 (E70258) sonar module	

Appendix E Hardware and software compatibility

The lists below identify the LightHouse 4 software version required to support the listed hardware and also the hardware's software version required to be compatible with the latest features and improvements in the LightHouse 4 operating system.

Note:

When upgrading your display's software, it is important to ensure that you also upgrade any networked Raymarine products to their latest available software versions. The LightHouse 4 software package available on the website also includes the latest software for networked products.

LightHouse 4 software download link

<https://www.raymarine.com/en-us/download/lighthouse-4-update-for-axiom-chartplotters>

LightHouse 4 v4.6.103

- NeuBoat Dock Basic System, part number: E70699.

LightHouse 4 v4.5.84

- **Alpha** performance displays.
- **RNS-8** PoE network switch.
- **RSW**-Wired wind transducer.
- Rhodan trolling motor (via Rhodan gateway with compatible firmware version).

LightHouse 4 v4.4.87

- **Axiom 2 XL** displays.
- Fischer Panda generators (via Fischer Panda Communication Interface FP-CAN to NMEA 2000 (Part number: 0031409), running software version 2.11 or later):
 - Perfect Power (iSeries)
 - Compact Power (excluding 'Basic line')
 - Hybrid Power

- Fischer Panda generators (via GP203 with firmware version 2.1.0.18 or greater):
 - P8 mini Digital
 - P9 mini Digital
 - P12 mini Digital
 - P15 mini Digital

LightHouse 4 v4.3.54

- **Axiom 2 Pro** displays.
- **RVM1600** sonar module (E70665).
- **CAM300** IP camera (E70660).

LightHouse 4 v4.1.140

- **YachtSense™ Link** router (E70640).
- **Raymarine app** v2.0.
- Support for **DJI™** drone (UAV) removed.

LightHouse 4 v4.0.85

- **CP100** (E70204) — Bundle v21.0.04 (application v21.0.22 / platform v21.0.20).
- **CP200** (E70256) — Bundle v21.0.04 (application v21.0.22 / platform v21.0.20).
- **CP370** (E70297) — Bundle v21.0.04 (application v21.0.22 / platform v21.0.20).
- **CP470** (E70298) — Bundle v21.0.04 (application v21.0.22 / platform v21.0.20).
- **CP570** (E70258) — Bundle v21.0.04 (application v21.0.22 / platform v21.0.20).
- **RVX1000** (E70511) — v4.0.70 (same version number as MFD software).
- **RMK-9** (A80217) — Bundle v20.0.8 (application v20.0.15, / platform v18.0.17).
- **RMK-10** (A80438 / T70293) — Bundle v20.0.8 (application v20.0.15, / platform v18.0.17).

Legacy eS and gS Series compatibility with Axiom displays

As Raymarine® continues to develop new features and capabilities for the LightHouse™ 4 operating system, the ability to downgrade some Axiom® models to LightHouse™ software version v3.11.42 (for the purposes of allowing mixed networks of Axiom and legacy eS/gS Series displays) has ended.

Note:

Axiom® Pro **displays manufactured after August 2022** can no longer be downgraded to a version of LightHouse which is compatible with mixed systems which include legacy eS and gS Series displays.

The following table lists Axiom® displays and their compatibility status with legacy eS/gS Series displays:

Display	Compatibility in mixed systems featuring eS/gS Series displays
Axiom®	Yes — Software must be downgraded to LightHouse v3.11.42
Axiom® +	No — NOT compatible with eS/gS systems. The LightHouse OS cannot be downgraded
Axiom® XL	Yes — Software must be downgraded to LightHouse v3.11.42
Axiom® 2 XL	No — NOT compatible with eS/gS systems. The LightHouse 4 OS cannot be downgraded
Axiom® 2 Pro	No — NOT compatible with eS/gS systems. The LightHouse 4 OS cannot be downgraded

Display	Compatibility in mixed systems featuring eS/gS Series displays
Axiom® Pro (pre-September 2022)	Yes — Software must be downgraded to LightHouse v3.11.42
Axiom® Pro (post-September 2022)	<p>No — Axiom® Pro displays manufactured after August 2022, and beginning with the following serial numbers, are NOT compatible with mixed systems featuring eS/gS Series displays:</p> <ul style="list-style-type: none"> • Axiom® Pro 9 RVX — E70371-1027106 • Axiom® Pro 12 RVX — E70372-0923640 • Axiom® Pro 16 RVX — E70373-1127908 • Axiom® Pro 9 S — E70481-1026853 • Axiom® Pro 12 S — E70482-0924052 • Axiom® Pro 16 S — E70483-1026473

If you wish to continue using a mixed system of newer Axiom displays and legacy eS/gS displays, you must ensure that these displays are NOT connected on the same RayNet or SeaTalk NG networks.

Appendix F Ethernet (IPv4) networking of Raymarine devices with third-party products

Raymarine uses a custom Ethernet (IPv4) networking configuration. Use the following information to help you understand how Raymarine's Ethernet (IPv4) implementation interacts with third-party Ethernet (IPv4) devices on your vessel, such as routers, switches, Access Points (APs) etc.

Important:

- Third-party networking products such as routers, switches, and Access Points (APs) *may* work when connected to Raymarine networks, when configured correctly. However, correct operation is not guaranteed. It's important to refer to the instructions provided by the relevant third-party device manufacturer, to ensure that your intended use of a third-party device is consistent with the device's design intent.
- Raymarine does not warrant that Raymarine products are compatible with products manufactured by any person or entity other than Raymarine.
- When using third-party products in your Raymarine electronics network, you should be aware of, and understand, the concepts and limitations described in the following Disclaimer: [p.25 – Disclaimer](#)

Overview

- Ethernet (IPv4) networking is a method for interconnecting multiple electronic devices, allowing many devices to function in a network and share data using only a single RJ45 or RayNet connection for each device.
- In order to function correctly, every Ethernet (IPv4) device (whether Raymarine or third-party) must have a unique IP address allocated to it, and it must not conflict with that of any other device.
- IPv4 addresses can be centrally-allocated to devices either **automatically**, using a method known as *DHCP* (Dynamic Host Configuration Protocol), or **manually** (i.e. allocated a static IP address). The most common method for allocating IPv4 addresses on vessel electronics networks is *DHCP*. In this configuration, the *server* device is known as a *DHCP server*.

Client / Server device	Example(s)
Raymarine IPv4 DHCP client	<ul style="list-style-type: none">• Radar scanner (e.g. <i>Quantum</i>)• Sonar module (e.g. <i>CP470</i>)• IP camera (e.g. <i>CAM300</i>)
Raymarine IPv4 DHCP server and self-addressing device	<ul style="list-style-type: none">• Chartplotter (MFD), running LightHouse 3 or LightHouse 4 (e.g. <i>Axiom</i>)• Marine Router (e.g. <i>YachtSense Link</i>)
Third-party IPv4 DHCP client	IP camera
Third-party IPv4 DHCP server	<ul style="list-style-type: none">• Router• Switch• Access Point (AP)

Note:

The DHCP server maintains a pool of IP addresses and “leases” an address to any DHCP-enabled client, when the client device first powers up and announces its presence on the network. Because the IP addresses are dynamic (leased) rather than static (permanently assigned), addresses no longer in use are automatically returned to the DHCP server's pool, for subsequent reallocation.

It's also possible to have multiple DHCP servers issuing addresses on an IPv4 network, but to avoid addressing conflicts, all DHCP servers must be carefully configured to only allocate IP addresses in distinct address ranges. The *subnet mask* must also be carefully configured, to ensure that devices can correctly communicate with one another.

Implementation

- Raymarine Ethernet (IPv4) devices expect to use a private **Raymarine IPv4 network**, which is designed to be internal to the vessel only. Raymarine has carefully chosen a specific IP address range (**198.18.0.0/21**) to ensure that it does not interfere with any external IP address ranges, or other legacy and real-world addressing constraints (including but not limited to marina Wi-Fi networks).

Note: Raymarine's IP address range is for **local traffic** within the **vessel's private Raymarine network only**, and does NOT traverse across Raymarine products to external networks, or to the Internet.

- In a Raymarine Ethernet (IPv4) network, IP addresses are self-allocated by certain Raymarine equipment in the following range: **198.18.0.32 to 198.18.3.255** (inclusive). **You must avoid placing any devices in this range using manual (static) IP addresses.**
- Whether your network includes only Raymarine Ethernet (IP) devices, or a mixture of Raymarine and third-party Ethernet (IPv4) devices, you have 3 options for configuring the Ethernet (IPv4) network and managing the IP addresses for your devices:
 1. Use a Raymarine device as the sole DHCP server to allocate IP addresses automatically to all Raymarine and third-party Ethernet (IPv4) devices on the network. **For the purposes of simplicity and reliability, this is the recommended option for most vessels.** The following Raymarine devices can act as DHCP servers:
 - a. **Raymarine chartplotter (MFD)**, running LightHouse 3 or LightHouse 4; or:
 - b. **Raymarine YachtSense Link router**

Note: If both a Raymarine chartplotter (MFD) and YachtSense Link router are present in the same network, the YachtSense Link router **MUST** be configured as the DHCP server for that network. To facilitate this, the Raymarine chartplotter's (MFD's) DHCP setting defaults to *Automatic* as standard. On power up, if the YachtSense Link router is detected on the Ethernet network, any chartplotters (MFDs) in the network will disable their own *DHCP Server*, to permit the YachtSense Link router to manage the network's IP addresses. Only Raymarine chartplotters (MFDs) running LightHouse 4 are compatible with the YachtSense Link router. Additionally, the most recent versions of the LightHouse 4 and YachtSense Link software must be used.

2. Use a third-party Ethernet (IPv4) device (such as a router or Access Point) to allocate IP addresses automatically, as a sole *DHCP server*. To do this, refer to the *Configuring a third-party router as DHCP server* section, below.

Note: Any Raymarine LightHouse 3 or LightHouse 4 chartplotters (MFDs) will still self-allocate their own IP address, even if a third-party DHCP server is being used to allocate IP addresses to other Raymarine or non-Raymarine *DHCP client* devices (Camera, Radar, Sonar etc.) on the network.

3. Manually configure static IP addresses for your devices. The address range **198.18.0.32 to 198.18.3.255** (inclusive) is used by Raymarine equipment, and any other third-party equipment on the network should not be set to a static IP address in this range. It should instead be set elsewhere in the 198.18.0.0/21 range.

Adding third-party devices to your Raymarine Ethernet (IP) network

- It is recommended that any third-party products connecting to a Raymarine Ethernet (IPv4) network (e.g., a third-party IP camera) are configured as DHCP clients, so that they automatically get allocated a correct IP address within the range used by the **Raymarine IPv4 network**. If this is not possible, (for example, in the scenario that your third-party IP Camera requires a static IP address), you should configure the product to have a static IP address within the following range: **198.18.0.1 to 198.18.0.31** (inclusive).
- Any third-party router in your network should be performing IPv4 *Network Address Translation* (NAT) from the private address to another one on an upstream interface.

Configuring a third-party router as DHCP server

In the scenario that you wish to use a third-party DHCP server to allocate the IP addresses for your vessel's IPv4 network, use the following information to help you configure the third-party DHCP server to work with Raymarine Ethernet (IPv4) client devices:

1. Configure the third-party DHCP server / router to use Raymarine's subnet details, which are as follows:
 - a. Set the DHCP server's IP address to **198.18.0.1**
 - b. Set the *netmask* to /21, i.e. **255.255.248.0**
 - c. Set the DHCP range from **198.18.4.0 to 198.18.7.254** (inclusive). If this is not possible, ensure that the address range is smaller than this (but within the range of **198.18.4.0 to 198.18.7.254** (inclusive)).

- d. The address range **198.18.0.32 to 198.18.3.255** (inclusive) is used by Raymarine equipment, and therefore you must ensure that any other third-party equipment on the network is NOT set to a static IP address in this range.
2. It may be necessary to set the DHCP setting for **all** of the chartplotters (MFDs) on the vessel to *[Off]*. However, the default option (*[Auto]*) will likely work fine in many cases. If for any reason the third-party DHCP server starts up after the chartplotter (MFD) starts up, the user should manually set the chartplotter's (MFD's) DHCP switch to *[Off]*. This is because, when the chartplotter (MFD) starts up, its DHCP *[Auto]* feature tries to detect if another DHCP server is already present on the network.
3. In case of failure of the third-party device, the chartplotters (MFDs) can be easily configured to be the DHCP server again, by setting the chartplotter's (MFD's) DHCP setting back to *[Auto]*.

Adding third-party Wi-Fi Access Points / Wi-Fi routers to your Raymarine Ethernet (IPv4) network

- There is a large volume of multicast IPv4 traffic on the Raymarine Ethernet (IPv4) network. Many consumer Wi-Fi Access Points / Wi-Fi routers simply bridge all multicast traffic from the Ethernet interface to the Wi-Fi interface when there are connected Wi-Fi clients. This will result not only in poor Wi-Fi performance but also in a reduction of usable Wi-Fi spectrum to other Wi-Fi users and vessels in the vicinity. If using a third-party Wi-Fi Access Point or Wi-Fi router, Raymarine recommends that *IGMP Snooping* is enabled on the third-party device, and additional checks are performed, in order to ensure that your device is not bridging any unexpected multicast traffic to its Wi-Fi interface from the Raymarine Ethernet (IPv4) network.
- Raymarine's YachtSense Link router is pre-configured with IGMP Snooping enabled, and therefore does not bridge internal multicast traffic on the wired network to the Wi-Fi network. No additional configuration is required in this respect.

Appendix G Android apk compatibility

Axiom and Axiom 2 displays are based on different versions of the Android operating system.

- Axiom displays are based on Android 6.0 (API 23) ARM7a (32-bit) system.
- Axiom 2 displays are based on Android 11.0 (API 30) ARM64 (64-bit) system.

This means that different versions of apps may be required for each platform. The list below shows the latest Raymarine approved apps which are compatible with Axiom and Axiom 2 displays.

App name	Axiom	Axiom 2	Comments
AnyDesk™	V 7.1.0	V 7.1.0	
Bouyweather®	V 1.0.2	Not supported	New versions are no longer supported.
Kinetix™	V 1.0	Not supported	Does not work on Axiom XL
Netflix®	V 7.120.0 build 7 35589	V 8.95.0 build 13 50554	
NV Charts	Not supported	V 2.718.200	
PredictWind®	V 4.9.4.0	V 5.0.1.0	
PredictWind® Offshore	V 6.7.1.4	V 7.0.3.0	Map flickers black on Axiom
Spotify®	V 8.8.88.397	V 8.8.88.397	
TheyR™ Gribview	V 5.6.2	V 5.6.2	
Windy™	V 27.3.1	V 40.0.7	Map flickers black on Axiom

Appendix H Glossary

Navigation glossary

Common terms and abbreviations used in navigation.

Term	Meaning
Active navigation	Active navigation is the term used when the display is performing navigation to a destination point. The destination point can be a 'Goto' (to an onscreen cursor position or a single waypoint), or part of a 'Follow' (to a waypoint within a route).
AIS (Automatic Identification System)	A tracking system enabling you to receive positional information broadcast by other vessels, and to transmit positional information for your own vessel. AIS is used to identify, locate and track marine vessels in the chart and radar applications. An AIS receiver or transceiver is required to view AIS information.
Auto range	A mode that ranges the chart application automatically, to ensure both the vessel and target waypoint are always visible.
Course Over Ground (COG)	COG is the actual direction of travel, relative to fixed land. Vessel heading may differ from COG due to the effects of currents, tide and wind. COG is transmitted by GNSS (GPS) receivers. Supported data: <ul style="list-style-type: none"> • NMEA 2000: PGN 129026 • NMEA 0183: RMC
Course up (CU / C-up)	The chart or radar is orientated so as to show your current course directly ahead of your vessel icon. The chart will rotate so that your Course Over Ground (COG) is always upward on the screen.

Term	Meaning
Cross Track Error (XTE)	The amount of deviation from your intended course, expressed as a distance. In the event that you steer off-track, you can create a new course to the target by selecting "Restart XTE" on your pilot controller or multifunction display.
Follow	The action whereby the display is placed in active navigation following a route.
GNSS (Global Navigation Satellite System)	A constellation of Earth orbiting satellites that can be used to plot latitude, longitude, altitude, Course Over Ground (COG), and Speed Over Ground (SOG).
Goto	The action whereby the display is placed in active navigation travelling to a cursor location or a single waypoint.
Head up (HU / H-up)	The chart or radar is orientated so as to show your current heading directly ahead of your vessel icon at all times. As your vessel changes direction, the chart or radar image rotates accordingly to reflect the new bearing. In Head-up, the motion mode is fixed to Relative motion.
Heading (HDG)	Compass direction of travel. Heading can be relative to True north or Magnetic north. Heading can be transmitted from a ship's compass or heading sensor. Supported data: <ul style="list-style-type: none"> • NMEA 2000: PGN 127237 / 127250 • NMEA 0183: HDG / HDM / HDT

Term	Meaning
Latitude (Lat)	A geographic coordinate which indicates the position of a point on the Earth that is either north or south of the equator. When provided as a coordinate, the number of degrees is determined in relation to how far (0° to 90°) north or south the coordinate is from the Earth's equator — where 90° refers to either the North Pole or South Pole and 0° refers to the equator. One degree of latitude is approximately equivalent to 60 nautical miles.
Longitude (Lon)	A geographic coordinate which indicates the position of a point on the Earth that is either east or west of the prime meridian. When provided as a coordinate, the number of degrees is determined in relation to how far (0° to 180°) east or west the coordinate is from the prime meridian.
North up (NU / N-up)	The chart or radar image is orientated so that true north is always upward on the screen. As your vessel changes direction, vessel icon (chart) or ship heading line (radar) rotate accordingly to show your relative position to true north.
Rate of Turn (RoT)	RoT is the speed at which your vessel turns in a given direction, typically when under autopilot control.
Relative Motion (RM)	In the Chart and Radar applications, relative motion mode fixes your vessel's position and the chart or radar image moves relative to your vessel. In Relative Motion mode you can use the <i>[Boat position]</i> setting to determine whether the vessel position is fixed in the <i>Center</i> of the chart display or has a <i>Partial offset</i> , or <i>Full offset</i> . Selecting the partial or full offset has the effect of increasing the view ahead.
Route (RTE)	A series of waypoints typically used to assist with journey planning and navigation. A route is displayed on screen as a series of waypoints linked by a line.

Term	Meaning
Speed Through Water (STW)	The speed of your vessel through the water, also known as boat speed. Due to tide and current this will be different than Speed Over Ground (SOG). STW is measured by a speed transducer. Supported data: <ul style="list-style-type: none"> • NMEA 2000: PGN 128259 • NMEA 0183: VHW
Time To Go (TTG)	The time remaining until you reach the destination point.
Track	A visible trail displayed in the Chart app on a multifunction display, showing the passage you have taken. The trail consists of a series of track points which are created automatically. You can save the track to create a permanent record of where you have been. You can also create a new route from a track.

Term	Meaning
True Motion (TM)	<p>True Motion mode fixes the chart position and the vessel icon moves across the screen. As the vessel's position approaches the edge of the screen, the chart image is automatically redrawn to reveal the area ahead of the vessel.</p> <p>As the vessel's position approaches the edge of the display, the image is automatically redrawn to reveal the area ahead of the vessel.</p> <div style="border: 1px solid black; padding: 5px; margin-top: 10px;"> <p>Note:</p> <p>True Motion mode is not available when the orientation is set to "Head-up".</p> </div>
Waypoint (WPT)	<p>A position marked on the screen to indicate a location to navigate to. Waypoint positions are defined by Longitude / Latitude coordinates, and can be saved for future use. As well as acting as position markers, waypoints are also the building blocks used to create routes. Waypoints can be created and displayed in the Chart, Radar, and Fishfinder apps on a multifunction display.</p>

Sailing glossary

Common terms and abbreviations used in sailing.

Term	Meaning
Apparent Wind	<p>The wind flow observed when in motion, relative to the boat's heading. Apparent wind is different from True wind in that it takes into account your own movement, i.e.: speed and direction of travel. Apparent wind is the raw data that is reported by wind transducers, which can then be used in conjunction with other data sources to calculate True wind.</p> <p>Supported data:</p> <ul style="list-style-type: none"> • NMEA 2000: PGN 130306 • NMEA 0183: MWV
Apparent Wind Angle (AWA)	<p>The wind angle observed when in motion, relative to the boat's heading. AWA is a combination of the true angle of the wind and the angle that is felt due to direction and speed of travel.</p>
Apparent Wind Speed (AWS)	<p>The wind speed observed when in motion. AWS is a combination of the true speed of the wind and the speed you are travelling.</p>
Distance to Tack	<p>The travel distance remaining until you need to tack.</p>
Distance to Line	<p>Distance remaining to the closest point along the race start line.</p>
Downwind	<p>Moving in the direction that the wind is blowing.</p>
Ground Wind Direction (GWD)	<p>The direction of the wind relative to north, as observed on land. This is the actual direction the wind is blowing.</p> <p>In addition to Apparent Wind Angle (AWA), Course Over Ground (COG) from a GNSS receiver is also required in order to calculate GWD.</p>

Term	Meaning
Ground Wind Speed (GWS)	The wind speed observed when stationary, as observed on land. GWS is the actual speed the wind is blowing over land. In addition to Apparent Wind Speed (AWS), Speed Over Ground (SOG) data from a GNSS receiver is also required in order to calculate GWS.
Header	A wind shift which causes your boat to turn more downwind.
Laylines	Vector lines showing the course the boat will take when sailing at the optimum angle to the wind, on either tack.
Leeway	The difference in angle between desired heading and actual course, caused by sideways movement of a sailing boat due to the wind.
Lift	A wind shift which allows your boat to turn upwind and closer to your destination.
Line bias	The distance advantage conferred by crossing the start line at the favored end (the end which is more upwind) of the race start line.
Polar table	A performance profile for a boat, showing the boat speed achievable at varying angles to the wind, with varying wind speed. In sailing, the Velocity Made Good (VMG) principle demonstrates that travelling in a straight line is not always the quickest route, and polars enable you to optimize your vessel's performance to its best advantage, by improving the accuracy of laylines to display how far you need to sail on a current tack to reach a target waypoint after tacking, and taking wind conditions into consideration.
RSW (Raymarine Smart Wind)	The Raymarine Smart Wind transducer series. The RSW series of transducers include a built-in attitude sensor, which is used to provide more accurate readings than standard wind transducers.

Term	Meaning
Sail plan	Sail configuration recommendations based on wind conditions.
Sailing upwind	Sailing close to the wind direction.
Tack	A course change made by a sailing vessel, by turning its heading into and through the wind.
Tacking	The zig-zag manoeuvre a sailing vessel makes when travelling upwind.
Time To Burn (TTB)	The time remaining during race start countdown before the boat needs to start moving towards the start line at full speed.
Time to Tack	The amount of time remaining until you need to tack, if the current course and speed are maintained based on the calculated laylines..
True Wind	The actual wind flow; it is the wind flow you feel, on the water, when stationary. True wind is calculated from Apparent wind data from a wind transducer and STW (Speed Through Water) from a speed transducer.
True Wind Angle (TWA)	The angle of the wind over water, relative to the boat's bow, observed when stationary.
True Wind Direction (TWD)	The direction of the wind relative to north. This is the actual direction the wind is blowing. In addition to Speed Through Water (STW), Heading is also required to calculate TWD.
True Wind Speed (TWS)	The wind speed observed when stationary, on the water. TWS is the actual speed the wind is blowing over water.
Velocity Made Good (VMG)	Sailing term related to the component of a sail vessel's velocity vector that is in the direction of true wind.
Wind shift	The amount of variation in True Wind Direction (TWD) over time.

Appendix I Document change history

Document revision and (Date)	Changes
81406 Rev 12 (03–2024) Software version: v4.6.103	<ul style="list-style-type: none"> • Added important note with regards to requirement to update v4.6.74 to v4.6.103. • Added EV-1 new software version v3.17 and EV-2 new software version v3.17 (supports <i>[Find me]</i> and <i>[Always off]</i> LED modes), to hardware software compatibility lists. • Added details of the RSW wind transducer’s automatic calibration process and how to reset the internal compass. • Removed details of the SeaTalk NG factory reset option. This feature has been removed.
81406 Rev 11 (02–2024) Software version: v4.6.74	<ul style="list-style-type: none"> • Updated New features list to reflect v4.6.74. • Added note to Fuel range ring details. • Added additional Fischer Panda generators to compatible hardware list for v4.4.70 v4.4.87. • Added NV charts to supported apk list in appendix. • Added details of the new SeaTalk NG factory reset option. • Increased AIS target capacity to 200.
81406 Rev 10 (12–2023) Software version: v4.6.42	<ul style="list-style-type: none"> • Updated New features list to reflect v4.6.42. • Added full details for AIS and Radar target context menus in Chart app and Radar app • Added Mercury <i>[Steering angle]</i> to <i>[Boat data]</i> items and <i>[Pilot data]</i> items. • Added <i>[Maximum SOG (All time)]</i> to <i>[GPS]</i> and <i>[Speed]</i> data categories. • Removed UAV chapter and UAV settings details in Chart app chapter.

Document revision and (Date)	Changes
	<ul style="list-style-type: none"> • Added details of new High speed alarm in Alarms chapter. • Added details of new <i>[Always off]</i> and <i>[Find me]</i> options for position sensor LEDs. • Added details of Route broadcast and receipt to First responder chapter. • Added details of new Intercept distance and time indication in target context menus. • Creeping line SAR pattern parameter named changed from <i>[Creep direction]</i> to <i>[Search orientation]</i>. Parallel line SAR pattern parameter name changed from <i>[Initial direction]</i> to <i>[1st leg direction]</i>. • Added THS to supported NMEA 0183 sentences. • Added details of new target data reference mode options in Radar app. • Added details on new <i>[Quick adjust]</i> menu in the Chart app. • Added details of the new <i>[Nav marks]</i> waypoint symbols. • Added details of new <i>[Fuel range]</i> ring in Chart app. • Added details of the new Generator <i>[Start]</i>/<i>[Stop]</i> options. • Added details of the following new data items: <i>[Next leg TWA]</i>, <i>[Target apparent wind angle]</i>, <i>[Target true wind angle]</i>, <i>[Maximum SOG (All time)]</i>, <i>[Opp. tack COG]</i> and <i>[Next track leg bearing]</i>. • Renamed <i>[Tack heading]</i> to <i>[Opp. tack heading]</i>. • Added details of new SkyHook Mercury feature to Mercury chapter.

Document revision and (Date)	Changes
	<ul style="list-style-type: none"> Updated Android apk compatibility list. Updated Document change history to reflect Rev 10 changes.
81406 Rev 09 (12–2023) Software version: v4.5.101	<ul style="list-style-type: none"> Updated ‘Software update’ details. Added Networking constraints to Getting started chapter. Added YouTube and YouTube TV chapter. Added YouTube and YouTube TV to available MFD apps. Added apk compatibility table to appendix. Added distraction disclaimer to entertainment app chapter. Added Neuboat dock system to hardware compatibility. <p>Note: v4.5.101 was not formally released. The feature was first available in v4.6.42</p>
81406 Rev 08 (09–2023) Software version: v4.5.84	<ul style="list-style-type: none"> Added new warnings covering anti virus protection and changing display mode in night conditions. Added Peripheral product software compatibility tables to appendix. Added New feature introduction lists to appendix. Added LightHouse software compatibility details to software chapter. Added sail plan details to Settings menu details, Boat details menu and Alarms Manager. Added Sail plan feature details.

Document revision and (Date)	Changes
	<ul style="list-style-type: none"> Added new Sailing features chapter and reorganized existing Chart app chapters. Added sail plan data items to Boat category list. Updated sail performance settings menu descriptions. Update Layline details. Added polar manager details. Updated details for connecting the display to the internet and moved to Getting started chapter. Updated checking for software updates online to cover wired connections. Added details of connection changes for YachtSense Link router software v4.20. Added IP Address conflict troubleshooting. Added IP networking guidance to appendix. Updated Hardware compatibility and Product software compatibility lists. Added Alpha display to sidebars and details of operations via MFD. Added PGN 130579 (Entertainment) to supported PGN list. Added details of the new Wind shift bar. Added details of Wind vane mode. Added details of RSW wind transducer configuration. Added new Trolling motor control chapter. Added diagnostic details for RNS-8. Added details of NeuBoat Dock app to MFD app details.

Document revision and (Date)	Changes
	<ul style="list-style-type: none"> • Merged First Responder and SAR pattern chapter with the LH3 USCG LightHouse operating instructions, document number: 81405. • Added details of new context menu drag in Radar app. • Added details of new data response settings to Dashboard app chapter. • Added details of NMEA 2000 and NMEA 0183 diagnostics menus. • Updated LightHouse charts store details to reflect direct purchase. • Added note on minimum range for ClearCruise object detection. • Added details of DST810 auto STW calibration. • The Laylines and Race Start feature details have been updated to add clarifications and further detail. • Added glossary to appendix.
81406 Rev 07b (07–2023) Software version v4.4.87	<ul style="list-style-type: none"> • Added details of expiring LightHouse chart subscriptions.

Document revision and (Date)	Changes
81406 Rev 07 (03–2023) Software version: v4.4.70/v4.4.87	<ul style="list-style-type: none"> • Added details of Fishfinder zoom mode including new 50:50 split view and changing zoom box size to the Fishfinder app chapter. • Added Frequency tuning details to Fishfinder app chapter. • Updated cartography selection details in Chart app chapter. • Updated Spotify app removal details. • Added details of Generator configuration settings. • Added details of new Generators dashboard page. • Added details of generator data items to data item list. • Updated taking screenshot details including changing image save location to: \Raymarine\Image files\. • Added details of Auto turn to The Chart app chapter’s navigation section. • Updated Chart app Waypoint goto and route follow task to include tasks for manual steering and autopilot steering for each. • Updated chart app overview paragraphs re-written and updated to use screenshots showing LightHouse 4. • Expanded details for chart motion, chart orientation and vessel icon settings in chart app chapter. • The ‘VesselView’ app has been renamed ‘Mercury’ app. • Added details for changing Quantum radar internal channel.

Document revision and (Date)	Changes
	<ul style="list-style-type: none"> • Added references to Axiom 2 XL displays. • Added details for ending support for downgrading Axiom Pro to v3.11.42. • Added details of new Mode icons on Homescreen. • Updated Chart app chapter Racing mode layline details with new screenshots and rewritten details. • Changed Fishfinder RealVision 3D channel name references to 3D Vision. • Removed ‘TVG’ sensitivity control from Fishfinder app. • Added 100 radar targets for Cyclone software v1.25 or later. • Added details of new ‘Tuned’ and 50/100/200 kHz sonar channels. • Added details of peripheral product software updates required for v4.4.87.
81406 Rev 06 (01–2023) Software version: v4.3.42/v4.3.54	<ul style="list-style-type: none"> • Added references to Axiom 2 MFDs throughout • Updated product documentation to include Axiom 2 Pro installation instructions. • Updated New features list to reflect v4.3.42. • Added Axiom 2 Pro to compatible displays. • Added Axiom 2 Pro memory card insertion and removal procedures. • Added Note about RCR-2 not being not compatible with Axiom 2. • Added Axiom 2 Pro physical control details. • Added Axiom 2 Pro keypad selection details. • Added RVM to AHRS calibration.

Document revision and (Date)	Changes
	<ul style="list-style-type: none"> • Updated assigning user configurable key details to include Axiom 2 Pro and added a list of functions that can be assigned. • Updated audio volume control to include RCA audio. • Added details of auto brightness. • Added details about Axiom 2 to software update note. • Added details of Axiom 2 GNSS receiver compatibility. • Added keypad selection and UCK selection to this display settings options. • Added 'Keep network awake' option for Axiom 2. • Added Axiom 2 Pro screen resolutions. • Added note regarding NMEA 0183 on Axiom 2. • Added details of Axiom 2 Pro pilot keypad LED status. • Added RVM CHIRP sonar app depth range. • Added new RVM color palettes. • Added Axiom 2 Pro buttons to engaging and disabling autopilot. • Updated UAV support note. • Added power on reset procedure for Axiom 2 Pro. • Updated note for NMEA 0183 support. • Added Axiom 2 Pro and CAM300 to hardware compatibility list. • Updated document change history.

Document revision and (Date)	Changes
81406 Rev 05 (12-2022) Software version: v4.3.42	<ul style="list-style-type: none"> • Added Mercury autopilot control details. • Added Mercury auto trim details. • Added new rudder bar details to chart app. • Updated software references to v4.3.42. • Updated new features list to reflect v4.3.42 features. • Added 'Battery alarms' and 'Apps and connected devices' settings to alarm settings. • Dashboard app chapter re-written. • Moved alarms manager details to dedicated chapter. • Split document information and software version details into separate chapters. • Removed battery number selection from start-up wizard boat details. • Updated document change history. • Updated details of factory reset procedure. • Added procedures for exporting and importing digital switching configurations. • Updated exporting user data and settings procedures. • Added image flip and mirror details to video app. • Added details of UAV supported MFDs and LightHouse versions. • Added UAV support removal from hardware compatibility list. • Split out Fishfinder app's Sonar display settings into sections for each channel type. • Updated layout and presentation of Fishfinder app's settings menus.

Document revision and (Date)	Changes
81406 Rev 04 (09–2022) Software version: v4.1.75/v4.1.140	Minor revision to fix a formatting error.
81406 Rev 03 (09–2022) Software version: v4.1.75/v4.1.140	<ul style="list-style-type: none"> • Updated software references to v4.1.75. • Updated Radar modes details to clarify that Radar modes are not available on Digital radomes (non-HD). • Updated new features list to include performance improvements. • Updated LightHouse chart details to include new regions.

Document revision and (Date)	Changes
81406 Rev 02 (06–2022) Software version: v4.1.65	<ul style="list-style-type: none"> • Updated software references to v4.1.65. • Added VesselView cruise control details. • Added VesselView troll control details. • Added VesselView splitscreen app page details. • Added battery configuration details. • Added details if waypoint symbol selection tabs. • Added YachtSense Link alarms to alarm manager settings. • Added YachtSense ecosystem chapter. • Added mobile sync option to My data page details. • Updated screenshots in Homescreen chapter to show LightHouse 4 UI. • Added details of diagnostic sonar recording to Fishfinder chapter. • Updated RealBathy and SonarChart live details and screenshots. • Added list of depth and position logging/recording features.
81406 Rev 01 (03–2022) Software version: v4.0.70/v4.0.77/v4.0.82/v4.0.85	First release.

Note:

This document (81406) is based on another document (81370), which has a longer history and includes a full historical list of changes to the LightHouse 3 software that occurred between versions v3.0.40 and v3.16.84. To see this list, refer to the following document: **81370**.

Index

3D	
Waypoints	316
3D Vision	
Controls	311

A

Account transfer	513
Activate Touchlock	79
active alarm indication	128
ActiveCaptain	246
Adjust Locked heading.....	79
Advance waypoint.....	142
AIS	244
Buddy	227
Enhanced AIS targets	250
Full data	226
High target alarm	376
Lost EPIRB	225
Lost MOB	225
Lost SART	225
Silent mode.....	103, 227, 344
Target capacity	225, 341
Target icons	223, 342
Target list.....	227, 341
Target options	227
Target tracking.....	341
AIS PAD	245
AIS target	
Context menu	194, 329
AIS targets.....	223
AIS names.....	227, 344
AIS types.....	227, 344
Blue force	376
Enhanced AIS targets	227, 343
Enhanced icons	224, 342
Enhanced target status.....	224, 343
Show.....	227, 343
Static targets.....	227, 344
AIS, Buddy.....	465

Alarm	
Lost depth alarm.....	363
Alarm manager	89
Alarms	
Acknowledgement.....	130
AIS high target	376
AIS safety messages.....	129
Anchor drag.....	129
Apps and connected devices	129
AX8 camera	129
Battery alarms.....	129
Cross track error (XTE).....	128
Dangerous	45
Dangerous AIS targets.....	128
Dangerous Radar targets.....	128
Deep water arrival	129
Digital switching.....	129
DSC.....	129
Engine.....	129
External speaker	130
Fishing range	129
Generators.....	129
Guard zone 1.....	128
Guard zone 2	128
High speed alarm	132
Lost Radar targets.....	128
Low fuel	129
Minimum sonar depth	129
MOB data type.....	129
Obstruction	237
Off track	128
Position drift.....	129
Sail recommendation.....	128
Shallow depth	129
Shallow water arrival.....	129
Warning	45
Water temperature.....	129
Waypoint arrival	128
YachtSense Link router.....	130
Alarms Alarms	
Digital switching.....	131
Alarms manager	128

Active alarms	127	Multi-zone	484
Alarms history	127	Multi-zone control	483
Alarms settings	127	Opening	479
Settings	128	Player controls	476
Alarms, warnings and information notifications	45	Reset	483
Align wind transducer	74	Settings	482
Aligning the rudder	136	Source	480
Anchoring		Zones	480
Anchor drag	284	Audio controls	476
Chain out	284	Audio receiver	475
Mark anchor position	284	Audio sidebar	478
Anchoring wizard	283	Augmented Reality	457
Android apk		AIS targets	466
Compatibility	553	AR200 setup	461
Versions	553	Camera installation and setup	458
apk	106	Cartography source	466
App launcher	89, 499	ClearCruise settings	466
App page icons	89	Compass bar	465–466
App pages		Compass lock	469
Creating	95	Compass offset	469
Customizing	95	Current reading	469
Delete	95	Deviation	469
Rename	95	Flags	463–464
Applicable documents	28	Goto flag	465
Applications	89	Overview	463
Apps	89	Range limit	466
LightHouse third-party	42	Reset calibration	469
MFD	42	Roll correction	467
AR200	468	Troubleshooting	529
Calibration	469	Waypoints	466
ARPA		Augmented Reality, camera FOV	459
Data source requirements	344	Auto turn	144
Audio	500	Automatic linearization	470
Speaker volume	81	Automatic turning	
Volume	79	Limits exceeded	216
Audio app	93, 475, 480	Autopilot	
app controls	476	Adjust locked heading	79
Balance	482	Advanced settings	143
Crossover	482	Control	140
Diagnostics mode	483	Debug	144
Fade	482	Disengage	141–142
Menu options	482	Engage or Disengage	79

Engaging.....	141
Pop-ups.....	143
Reset.....	144
Shortcuts.....	80
Sidebar	142
Standby.....	141
Status.....	142
Autopilot set-up	
Deadband angles	146
Rudder Damping.....	146
Autorouting.....	162

B

Back up	
Settings.....	106
User data	106
Backup	104
MFD settings.....	107
Routes.....	107
Tracks	107
Waypoints	107
Battery	
Configuration	69, 114
Battery configuration	114
Battery data	50, 392, 432
Bearing alignment	338
Bearing mode.....	119, 410
BeiDou.....	97
Bidata page	404
Bird mode.....	339
Blue Force	
AIS targets	376
Bluetooth	
Audio	83, 502
Connection	501
Disabling	501
Enabling.....	501
pairing speaker	83, 502
Settings.....	501
Speaker volume.....	81, 502
Volume	79, 500

Bluetooth keyboard	
Connection	63
Controls	62
Bluetooth Settings.....	63
Boat data	51, 392, 432, 435
Boat details.....	112
Tanks	
Calibration.....	116–117
Calibration points	116
Boat length	113
Boat name	113
Boat type	113
Bow to GPS	113
Bright sun	244
Brightness	79, 81, 121
Buddy, add to list from AR flag	465
Buoy mode	339

C

Calibration	468
Automatic STW	75
Depth	71, 313
DST810	75–76
iTC-5	73
Linearization	468
RealVision™	72
STW	76
transducer.....	73
Calibration lock.....	144
Calibration sources.....	71
Camera	
Tracking	202, 331
Cartography	
Selection.....	196
Chart.....	197, 247
Advanced settings	250
Aerial overlay.....	246
Aerial overlay coverage.....	246
Aerial overlay visibility	246
Anchor mode	197
Auto find ship.....	250

Auto range.....	198	Tide graph	277
Boat position.....	198, 249	Tide graphic.....	278
Cartographic objects	250	Tide station.....	277
Chart orientation.....	198	Tides	245
ClearCruise	242	Tides mode.....	197, 276
Controls	192	True motion	198
Course-up.....	198	View & motion settings	249
Current animation	276	Weather mode.....	197
Current graph	278	Weather settings.....	272
Current station	278	Chart / Radar Sync.....	229
Cursor info boxes	250	Chart app.....	90, 191
Depth settings	247	Cartography selection	196
Field of View (FOV).....	242	Context menu	194
Find nearest.....	239	Fishing chart mode	255
Fish mapping		Fuel range ring.....	200
Fishing Recommendations.....	259	Laylines.....	286
Layer identification.....	260	Navigate mode	253
Sea temp limits.....	261	Overview.....	191
Fish mapping layers.....	260	Quick adjust.....	193
Fish mapping mode	197, 258	Racing mode.....	286
Fishing mode	197	RealBathy.....	221
Head-up.....	198	Rudder bar indicator	218
Layer settings	244	Simulator.....	192
Layers	201	Winds shift bar	293
My data appearance.....	251	Chart appearance.....	251
Navigate mode	197	Chart appObject information	
North-up.....	198	Cursor info boxes	201
Race start line	300	Chart detail	244
Racing mode.....	197	Chart motion.....	249
Radar overlay.....	250	Auto range.....	249
Radar settings.....	229	Motion modes.....	197
Relative motion.....	198	Relative motion	249
Safe contour	247	True motion	249
Search for objects.....	239	Chart Object Size	244
Shallow area	247	Chart orientation.....	249–250
Shallow contour.....	247	Course-up.....	249–250
Show soundings	247	Head-up.....	249–250
SOG for vectors	250	North-up.....	249–250
Sync view with other charts.....	249	Chart racing mode	
Tide animation	276	Distance To Line.....	303
Tide animation interval	250	Edit Line	303
Tide bar.....	278	Line Bias	303

Race Timer.....	303
Time To Burn.....	303
Chart settings	
Page settings menu.....	251
Chart Store.....	204, 492
Chart style.....	244
Chart,	
Modes.....	196
Checking rudder drive.....	138
CHIRP	
DownVision™ overview.....	306
RealVision™ 3D	
3D Vision.....	308
Sonar overview.....	305
Technology.....	305
Cleaning.....	25
ClearCruise	
Augmented Reality.....	459
Augmented Reality (AR).....	457
Object detection.....	457, 461–462
close hauled indicators.....	402
Close hauled indicators.....	402
Coastal mode.....	339
COG / SOG filter.....	100, 102
Collision avoidance	
Course change.....	233, 235
Moving target.....	232
Predicted Area of Danger zone.....	231
Predicted areas of danger.....	232
Speed change.....	234–235
Stationary target.....	232
Color gain.....	319
Commissioning pre-requisites.....	135
Commissioning steps.....	135
Community edits.....	246
Compass	
Alignment.....	144
Linearization.....	468–469
Lock.....	144
Offset.....	143
Restart.....	144
Compass linearization.....	135

Compass lock.....	135, 140, 470
Compatible displays.....	31
Compatible entertainment systems.....	475–476
Compatible hardware.....	548
Compatible software.....	546
Connecting	
RayControl.....	496
RayRemote.....	497
RayView.....	497
Connection	
NMEA 0183.....	125
Connections.....	88
Bluetooth.....	501
Internet.....	84–85
MFD.....	504
Wi-Fi.....	85
YachtSense System.....	504
Contact details.....	536
Context menu.....	194
Context menus.....	44
Controls	
Bluetooth keyboard.....	62
Chart.....	192
Dashboard.....	390
Fishfinder.....	310
Radar.....	328
Uni-controller.....	61
Video app.....	442
Yamaha app.....	431
CPA.....	348
Crash logs.....	515–516
Cruise speed.....	144
CSP.....	174
CSP (Commence Search Point).....	169, 171
Cursor info boxes.....	201
Cyclops load cells.....	56, 397
CZone plug and play.....	406

D

Dangerous targets alarm.....	231
AIS targets.....	231

Ignore static targets	128, 231	Display voltage	51, 392
Radar targets	231	Distance	51, 393, 432–433
Show safe distance	231	Engine	51, 393, 432–433
Dashboard		Environment	52, 394
Dynamic tile	96	Environmental	432, 434
Dashboard app	92, 390, 400, 402, 406, 411–412	Fresh water tank	55, 396
Advanced settings menu	411	Fuel	52, 393, 432, 434–435
Bidata page	404	Fuel (Gasoline) tank	55, 396
COG/SOG filter	411	Generator	55, 397
controls	390	GNSS (GPS)	432
Custom RPM red zone	411	Grey water tank	55, 396
Customize data	391	Heading	53, 395, 432
Data damping	411	Inside environment	53, 394
Data items	50, 392	Live well tank	55, 396
Data pages	391	Load cells	56, 397
Data response	411	Navigation	53, 395, 433
Depth response	411	Pilot	54, 395, 432–433
Engine dial	398	Speed	54, 395, 432–433
Engine page	398	Tanks	55, 396
Fuel dial	403	Time	54, 396, 434
Fuel page	403	Wind	54, 396, 434
Heading response	411	Data import and export	104
Maximum RPM	411	Data items	
Navigation dial	401	Dashboard	50, 392
Navigation page	401	Data overlays	49–50, 392
Race start page	302, 400	Sidebar	50, 392
Rolling road page	402	Data logging	56, 525
RPM Damping	411	Data overlay	
RPM settings	411	Data items	50, 392
Sailing dial	302, 399–400	Data overlays	49–50, 392
Sailing page	399	Data sources	69
Single data page	404	Selection	69
STW response	411	Datamaster	122
Tanks page	403	Designation	122
Wind angle response	411	Multiple	63
Wind shift bar	293	Selection	63
Wind speed response	411	Date format	118, 409
Data	53, 394, 432–433	Day color palette	244
Battery	50, 392, 432	Deadband angles	146
Black water tank	55, 396	Deep contour	247
Boat	51, 392, 432, 435	Deep water color	247
Depth	51, 392	Delete rulers	242

Deleting a boat.....	510
Demo	
Movie.....	109
Profiles.....	109
Demo movie	
format.....	109
Demo profiles.....	192
Density.....	248
Depth.....	432–433
Depth calibration.....	71, 313
Depth contour	
Options.....	219
Depth contours.....	56, 219, 221, 525
Depth data.....	51, 392, 432–433
Depth data logging.....	56, 525
Depth gradient.....	247
Depth logging.....	56, 525
Depth markers.....	378
Depth measurement lost.....	363
Depth offset.....	71, 313
Depth recording.....	221
Depth soundings	
Options.....	219
Units.....	218
Depth units.....	118, 409
Diagnostics.....	537
NMEA 0183.....	517
NMEA 2000.....	518
Product info.....	515–516
Sonar recording.....	525–526
Direct message.....	387
Disable all Sounders.....	79
Display	
Buttons.....	59–60
Controls.....	59–60
Display brightness.....	81
Display data.....	50, 392
Display mode.....	79, 82
Display standby.....	59
Display voltage data.....	51, 392
Distance data.....	51, 393, 432–433
Distance units.....	118, 409

Dock-to-dock.....	162
DockSense app.....	94
Dockside wizard.....	135, 144
Document history.....	558
Documentation	
Operation instructions.....	28
Doppler.....	230
Data source requirements.....	351
Overview.....	350
Drive polarity.....	145
Drive type.....	136, 143
DSC	
Distress call.....	132
Notifications.....	132
Target list.....	371
Target options.....	371
DSC targets.....	223, 371
Dynamic tile.....	92, 96–97

E

Easy Routing.....	162
Easy View.....	246
Economy units.....	118, 410
Eject SD card.....	79–80, 104
Engage / Disengage autopilot.....	79
Engine	
Custom RPM red zone.....	411
Fault codes.....	427
Maximum RPM.....	411
RPM Damping.....	411
Engine connection wizard.....	113
Engine data.....	51, 393, 432–433
Engine identification wizard.....	68
Engine manufacturer.....	114
Engine page	
Engine dial.....	398
Engine quad display.....	114
Engine selection.....	113
Entertainment systems.....	475
Environment data.....	52, 394, 432, 434
Environment sensors.....	114

eS Series	34, 549
Ethernet.....	550
Event groups	157
Export	
Routes.....	107
Settings.....	106
Tracks	107
User data	106
Waypoints	107
External storage	
Eject SD card	79
Inserting.....	41
Removal.....	41–42

F

Factory reset	70, 520
File browser.....	104, 106
First power up	63
First responder	361
AIS mode	361, 375
Asset type.....	361
Broadcasting a route	366
Cancelling sent routes	368
Context menu	377
Data logging	361, 364
FID	361–362
FID checksums	362
Following received route	368
Messages app	94, 104
Messaging app	385
MMSI.....	361
No Hdg	363
No SOG.....	363
OneShot TOI settings	361
Passphrase	361
Password protection.....	361
Receiving a route.....	368
Route broadcast	365
Route receipt	365
SAR divert.....	186
Sending a route	366

SITREP	376
SRU.....	184
Accepting managed search	185
Unit name	361
Unit type	361
Fish detection.....	318
Detection sensitivity.....	318
Fish depth labels.....	318
Fish detection beep.....	318
Fish icons.....	318
Fish mapping, <i>See</i> Chart Fish mapping mode	
Fishfinder	
A-scope.....	323
Background	321
Boat icon.....	321
Bottom colors.....	321
Bottom fill.....	323
Bottom lock.....	323
Color palette	322
Color targets by	321
Color threshold	322–323
Depth lines.....	323
Fish depth labels.....	326
Fish detection	325–326
Fish detection sensitivity.....	326
Fish icons.....	326
Invert colors	321–323
Range lines	322
Scroll speed.....	322–323
Show targets as	321
target colors.....	321, 323
View mode.....	321
View selection buttons	322
White line	323
Zoom mode	310
Fishfinder app.....	91, 326
App overview.....	309
Auto range	310
Channels.....	315
Controls	310
Frequency tuning.....	319
History.....	318

No source	312
No transducer	312
Range	310
Scroll back	318
Sonar recording	525–526
Tune frequency.....	319
Waypoints	315
Zoom mode	316
Zoom view	317
Fishing AOI	246
Fishing range.....	248
Fixed angles	
Downwind angle.....	113
Upwind angle.....	113
FOV layer	245
Fuel data.....	52, 393, 432, 434–435
Fuel manager	104
Set-up	105
Fuel page	
Fuel dial	403
Fuel range	200
Fuel tanks	
Fuel.....	117
Fuel (propulsive)	117
Not for propulsion.....	117
Fusion.....	476
G	
Galileo	97
Generator configuration	114
Generator data	55, 397
Generators	
Configure	115
GLONASS	98
Glossary	
Navigation.....	554
Sailing	556
GNSS / GPS	88
GNSS (GPS)	99
COG / SOG filter	100, 102
Constellations	98, 100

Differential positioning.....	100–101
Internal receiver.....	100, 102
SBAS.....	100–101
GNSS (GPS) constellations.	97
GNSS (GPS) data	432
GNSS (GPS) Settings	99
GNSS constellation selection	101
GNSS/GPS troubleshooting.....	522
GNSS(GPS)	
Data	53, 394
GNSS(GPS) data	53, 394
Goto waypoint	211–212, 299
GPS.....	97, 99
gpx.....	106
gS Series	34, 549
Guard zone alarms	350
Guest mode	509
Guest profiles	108
Gybe	145

H

Harbor mode	339
Hard over time.....	145
Hard-over time	135, 137
Heading data.....	53, 395, 432
Height correction.....	248
High res bathy	246
Homescreen.....	88
Background image	89
Dynamic tile	96–97
Mode icons	95
Settings menu.....	111
Settings menus	89
Settings pages.....	43
Homescreen customization.....	120
Homescreen pages	89

I

Image.....	106
Import	

Settings.....	106
User data.....	106
Import tank calibration.....	117
Import/export.....	104
Initial setup.....	63
Inside environment data.....	53, 394
Intel	
Target list.....	370
Targets.....	370
Intel target	
Target options.....	370
Intel targets.....	223
Internet connection.....	84
IP address.....	537
IP address conflict.....	532
IP device.....	123
IP networking.....	550
IRPCS / COLREGS.....	231
iTC-5 calibration.....	73

J

JL Audio.....	476
---------------	-----

L

Languages.....	64, 112
Selection.....	112
Lat/Long format.....	118, 410
Laylines.....	286, 292, 299
Adjust for tides.....	289
displaying and interpreting.....	287
Fixed angles.....	288
Polar.....	289
system requirements.....	287
Wind shifts.....	292
LightHouse	
Downgrade.....	34, 549
LightHouse 4	
Compatible displays.....	31
LightHouse charts.....	239
LightHouse™ charts	

Premium.....	204, 492
LightHouse™ charts	
Premium subscription.....	88
LightHouse Charts.....	204, 492
Lighthouse third-party apps	
Install.....	500
LightHouse third-party apps.....	499
Background app.....	500
Lighthouse_id.txt.....	106
Limitation on use (LOU).....	68
Limitations on Use.....	88
Limitations on Use (LoU).....	88
Linearise transducer.....	74
Linearization.....	468–469
LiveView.....	157
Load cells.....	56, 397
Locked heading.....	141, 143
Loran	
ASF 1.....	119, 410
ASF 2.....	119, 410
Chain.....	119, 410
Slave 1.....	119, 410
Slave 2.....	119, 410
Loran TDs.....	156

M

Magnetic deviation.....	469
Magnetic interference.....	468
Main menu.....	43
Man Over Board (MOB).....	88
Man Overboard (MOB).....	131
Manual variation.....	119, 410
Marine protected areas.....	246
Measure.....	241
Memory cards	
Compatibility.....	39
Menus	
Pop-over.....	44
Settings.....	111
Types.....	43
Mercury.....	415–416, 418

Active Trim	423	Context menus.....	44
Active Trim sidebar	423	Main menu	43
Alarms.....	416	MFD apps	89
Alternator voltage	416	Audio app	93
Autoheading	422	Chart app.....	90
Autopilot control	420	Dashboard app	92
Autopilot sidebar	420	DockSense app	94
Autopilot standby.....	423	Fishfinder app.....	91
Cruise control	425	Mercury app.....	92, 414
Enabling cruise control	425	Messages app	94, 104
Enabling troll control.....	425	NeuBoat Dock app	94
Engaging Autoheading	422	PDF viewer app	93
Engaging Route mode	422	Radar app	90
Engine messages.....	416	Video app	93
Fault codes	427	YachtSense app.....	94
Information messages	418	Yamaha app.....	93
Notices.....	417	Yamaha HDMI app.....	93
Route mode	422	MFD Apps	
Sidebar	418	YouTube	472
SkyHook	419	YouTube TV.....	472
SkyHook sidebar	419	MicroSD	
Splitscreen pages	415	Adaptor	39
Steering angle indicator.....	416	Inserting.....	40–41
Troll control.....	424	Removal	40–41
Warnings.....	417	Minimum safe depth	65–66, 162
Mercury app	92, 414	Minimum safe height	66, 162
Sport exhaust.....	426	Minimum safe width.....	67, 162
Steering angle indicator.....	426	Miracast.....	124
Message inbox	385	Mobile apps.....	490
Messages		Raymarine.....	491
Character limit.....	385–387	Mobile sync	104
Export	386	Motor phasing	145
New broadcast.....	386	Multifunction display operation	
New direct message.....	386–387	Settings page.....	49
Received	386	Sidebar menu	48
Sent.....	386	Multiple data sources (MDS).....	69
Sort by	386	Mute	480
Messages app	94, 104, 385	My data.....	89, 104
Messaging app		My profiles	108
Transmission type.....	385		
MFD alarms	500		
MFD app			

N

Navigating	211–212, 299
Navigation	
Glossary	554
Navigation data	53, 395, 433
Navigation mode	141, 143
Navigation page	
Navigation dial	401
Navionics	
SonarChart Live	222
Navionics plotter sync	496
Networking (IP)	
Overview	550
NeuBoat Dock app	94
New features	32, 543–544
NMEA 0183	
Baud rate	125
Exporting Routes	381
Exporting waypoints	381
Importing Routes	380
Importing waypoints	380
NMEA 0183 diagnostics	517
NMEA 2000	540
NMEA 2000 diagnostics	518
Notifications	45

O

Object detection	461
ClearCruise settings	462
Object information	201
Obstruction alarm	237
Parameters	237
Offboarding	513
Offshore mode	339

P

Page settings menu	326, 412
Pairing	
Quantum radar	82
RMK keypad	82

PDF	106
PDF Viewer	
controls	488
Opening files	487
Overview	487
Searching a PDF	488
PDF viewer app	93
PGNs	540
Pilot data	54, 395, 432–433
Pilot icon	140
Pilot sidebar	140
Placing a waypoint	155–156
Point camera here	202, 331
point to point	241
Polar table	
Activate polar	291
Adjustment	291–292
Copy	292
csv file layout	290
Delete polar	292
Duplicate	292
Importing	290
Rename polar	292
Pop-over menus	44
Position	99
Position logging	56, 525
Position sensor	
Find me	123
Find Me	123
Position sensor LED	
Find Me	123
Go dark	123
LEDs off	123
Power off	79
Power steering	144
Power swipe	59
Power troubleshooting	519
Powering off	58–59
Powering on	58
Premium subscription	88
Pressure units	118, 410
Primary MFD	122

Product information.....	537
Product support.....	536
Profiles.....	88

Q

Quick adjust menu.....	193
------------------------	-----

R

Race start line	
Creation.....	300
Delete.....	301
Edit.....	301
Race start Line	
creating.....	300
Race start page	
Sailing dial.....	302, 400
Race Timer	
starting.....	301
Radar.....	229, 244, 346
Antenna size selection.....	337
Bearing alignment.....	338
Blank sectors.....	352
Color Gain.....	353
Comparison.....	332
Compatible scanners.....	331
Controls.....	328
Dual range.....	229, 337
Dual range channel.....	229
Features.....	332
Gain.....	353
MARPA.....	228, 345
Modes.....	338
Overlay.....	230
Overlay color palette.....	230
Overlay visibility.....	230
Overlay without heading.....	230
Powering off.....	336
Rain.....	353
Range.....	230
Range and Bearing.....	340

Range rings.....	339
Preferred number.....	339
Sea.....	353
Sector blanking.....	230
Selecting a scanner.....	336
Selection.....	229
Sensitivity controls.....	353
Standby.....	336
Stop transmitting.....	79
Target options.....	228
Target settings.....	347
Timed transmit.....	337
Transmit.....	229
Radar app.....	90, 328
AIS targets.....	341
Context menu.....	329
Dragging context menu.....	331
Radar Doppler	
Color palettes.....	351
Mode.....	351
Radar PAD.....	245
Radar settings	
Advanced menu.....	357
Antenna size selection.....	354
Beam sharpening.....	356
Beam sharpening amount.....	356
Bearing alignment.....	357
Blank sector.....	357
Boat position.....	355
Channel shown in this app.....	354
Color palette.....	355
Dual range.....	354
Expanded returns.....	356
Expansion level.....	356
Installation menu.....	356
Interference rejection.....	356
Interference rejection level.....	356
Main Bang Suppression (MBS).....	357
Menu.....	353
Motion mode.....	355
Near Target Enhancement.....	356
Orientation.....	355

Page settings menu	358	True mode	347
Parking offset.....	357	Vectors	347
Preferences menu	356	Radar targets.....	223
Presentation menu.....	355	Radar troubleshooting.....	521
Radar Rotation Speed.....	356	Range rings	244, 339
Range Fusion.....	354	RayControl.....	490, 496
Range ring labels.....	355	Raymarine app	
Range ring mode	355	Guest mode	509
Range rings.....	355	RayNet.....	550
Reset.....	357–358	RayRemote	490, 497
Rings	355	RayView.....	490, 497
Scanner.....	354	RealBathy	56, 221, 247, 525
Sea clutter curve.....	357	Record depth data.....	247
Show waypoints.....	355	Recording sonar	526
Standby.....	354	Recovery mode	520
STC preset.....	357	Reeds almanac.....	239
Timed transmit.....	354	Regulatory approvals	25
Transmission menu.....	354	Responder	
Transmit	354	Settings.....	361
Transmit frequency.....	356	Restore	104
Tune adjust.....	356	Rockford Fosgate	475
Tune preset	357	Rolling road page	402
View & motion menu.....	354	Rotating mast.....	77
VRM/EBL reference	356	Route	159
Wired adapter channel	357	Add waypoint.....	163
Zero range	358	Capacity.....	159, 166, 383
Zero rotation position	357	Color	164
Radar target		Creation	159
Automatic acquisition	345–346	Delete	164
Cancel target	348	Export	164
Cancel targets.....	229, 346	Follow	163, 213–214, 217
Clear trails.....	348	Follow from here.....	163
Context menu	195, 330, 348	Hide/show.....	164
History.....	347	highlighting	160
Information.....	348	Importing.....	162
Manual acquisition.....	228, 345	List	104, 163
Reference mode	347–348	New route	163
Relative mode.....	347	Options	163
Shown CPA	348	Rename.....	164
Symbols	228, 344	Reverse.....	163
Tracking	344	Show/Hide	163
Trails (Wakes).....	348	Speed	164

Time	164
View route plan.....	163
Route options	164
Routes	
Broadcasting (First responder).....	366
Cancelling sent routes	368
Sending (First responder)	366
Sharing.....	165
RSW Wired	
Configuration	77
Rudder	
Damping	144
Limit	145
Offset	145
Reverse reference	145
Rudder bar.....	142, 245
Rudder bar indicator.....	218
Rudder Damping	146
Rudder limit	137
Ruler	241

S

S-63 Encrypted Charts	206
Base cells.....	208
Cell permits.....	208
Chart app settings	210
Cumulative update files	209
Expiry	210
Installation process	206
Installed charts.....	210
MFD activation file	207
Purchasing	208
Scheme administrator certificate	207, 210
SSE-06 notification	208
SSE-22 notification	208
Update charts	210
User permit	210
User permits file.....	208
Safe depth, minimum.....	113
Safe distance.....	231
Safe height, minimum.....	113

Safe width, minimum	113
Sail performance	113, 286, 289
Boat type	289
Downwind angle	289
Fixed Angles	286
Mirrored TWA	286
Polar.....	113, 286
Upwind angle.....	289
Sail plan	
Import.....	295
Layout	294
Recommendations	294
Template file	294
Sail plan recommendation.....	113
Sailing.....	293
Data page	296
Glossary	556
Race start line	299–300
Race timer.....	299, 301
SmartStart	299
Steer to wind.....	296
Time to burn	299
Wind vane mode.....	296
Sailing dial	402
Sailing dials	400
Sailing page	
Sailing dial.....	399
SAR.....	168
Abort.....	186
creation.....	169, 171, 174
Divert	185–186
Diverting	186
End divert.....	185
Expanding square pattern	171
Managed broadcast.....	182
pattern	168
Polygon search	178
Polygon search pattern.....	178
Resume	185
search controls	185
Searches list	188
Sector search pattern	169

SMC instructed divert	186	Data items.....	50, 392
Trackline search (non-return).....	176	Mercury.....	48, 418
Trackline search (non-return) pattern	177	Pilot.....	47
Trackline search (return).....	175	Race start.....	47
Trackline search (return) pattern.....	176	Search.....	47
Un-managed broadcast.....	180	Selection.....	142
SAR pattern		Selector.....	46
Receipt.....	181	Trolling	47, 148, 150–152
SAR Pattern		Sidebar	
Set and Drifts effects	170, 173	Audio	478
Save settings.....	107	Simulator	192
Save to	247	<i>See also</i> Demo	
Saving		Single data page	404
Product information	515	Sirius.....	258
SBAS	100–101	Subscription.....	261, 272
SBAS selection	98, 101	Sirius XM	246
Screen mirroring.....	124	SiriusXM	475
Screen resolutions.....	119	SiriusXM weather	263
Screenshot	79	Slew to Cue	202, 331
Search and Rescue, <i>See</i> SAR		Software	
Search and Rescue (SAR) patterns.....	174	Compatible MFDs	548
Secure messaging.....	385	Compatible software.....	546
Service Center.....	536	Software updates	35–37
Setting controls	44	Software version.....	31
Settings		Sonar	
Import.....	108	Channel selection	311
Restore	106, 108	Depth markers	378
Settings menu		Disable all sounders	79
Regulatory approvals.....	25	Gain	319
Settings pages.....	43	History.....	318
Settings reset	70	Intensity	319
setup.....	361	Noise filter.....	319
Shallow depth shading.....	248	Sensitivity controls.....	319
Shared brightness	121	Surface filter.....	319
Shortcuts menu	79	Sonar logs	248
Show contours.....	247	Sonar recording.....	56, 525–526
Sidebar	46	SonarChart Live.....	56, 222, 248, 525
Alpha display	47	Tide correction.....	222
Audio	48	Speed	
Customizing.....	48	Adjust STW	75
Data 1.....	46	Calibration.....	75
Data 2	46	Export calibration data.....	75

Import calibration data	75
Reset to default.....	75
Set STW to SOG	75
Speed data	54, 395, 432–433
Speed input	143
Speed units	118, 409
Splashscreen customization.....	120
Splashscreen resolution	119
Sports fishing.....	246
Spotify	33
SRU	
search controls	185
Startup wizard	64
Status area	102
Status area icons	103
STEDs	
Software updates.....	361
Steer to Hdg	142
Steer to Nav.....	142
Steer to wind	296
Stop Radar transmitting.....	79
Streets & POI	245
Support forum	538
Switching off.....	58–59
Switching on.....	58
System checks	
Bearing alignment.....	338
System Datum	119, 410
System time	88

T

Tacking	298
Take Screenshot	79
Tank calibration.....	114
Tank data.....	55, 396
Tanks	115
Black water tanks.....	115
Calibration.....	116
Fresh water tanks	115
Fuel (gasoline) tanks.....	115
Fuel tanks	115

Gray water tanks.....	115
Live well tanks	115
Tanks page.....	403
Target acquisition	
Data source requirements	344
Target context menu	
Data reference mode.....	349
Target list.....	229, 346
Target of Interest (TOI)	
OneShot.....	373
Position updates	374
Received	372
Repeating	373
Sent.....	372
Target icons.....	372
Transmission rate.....	373
Target options	226, 228, 370–371, 374
Target tracking	223
AIS	223
DSC.....	223
Intel.....	223
Radar	223
TOI	223
Targets	
Intel.....	370
Targets of Interest	223
Technical support.....	536, 538
Temperature units	118, 409
Thermal camera	
Tracking	202, 331
third-party apps	
LightHouse third-party apps	499
Third-party apps	499
Tide correction	248
Tide height	278
Tides mode	
Animation controls.....	277
Displaying graphs	280
Time data.....	54, 396, 434
Time format	118, 410
TOI	
OneShot decay.....	373

OneShot decay times	373
OneShot Delay	373
Target list.....	375
Touchlock	80
Track	
Capacity.....	166, 383
Track with camera	202, 331
Tracking	
Thermal Camera	202, 331
Tracks	164
Capacity	164
Creation	164
Customize.....	165
Interval.....	165
List	104, 165
Sharing.....	165
Traditional sonar.....	305
Trails clearing	348
Trails reset.....	348
Training courses.....	538
Transducer	
Temperature calibration	72, 313
Temperature settings.....	72, 313
Transfer ownership.....	513
Trip	
Counter.....	104
Trip logs.....	104
Trolling motor	148
Alarms.....	153
Anchor mode	150
Autopilot integration	148
Direct control	148
Distance limit.....	153
Hold heading mode.....	151
Integration.....	148
Manual control	150
Navigation mode	152
Wireless fob integration.....	148
Troubleshooting	515
Augmented Reality	529
IP addresses	532
Sonar	523

U

Units	118, 409
Unmute.....	480
Unpairing	
RMK keypad.....	82
Upgrading, software	35
Used for propulsion.....	117
User Configurable key.....	70
User data	104
Import.....	108
Restore	108
Back up	106
User interface	
Languages	112
User profiles	108

V

Variation	119, 410
Vessel hull type	135, 143
Vessel Hull Type	135
Vessel to point.....	241
VesselView	
Autopilot control	420
Autopilot sidebar	420
Video	441
Feed selection	446
Renaming feeds.....	442
Video Analytics.....	461–462
Video app.....	93
Controls	442
Image flip	443
Mirror image	443
Video app pages	441
Video playback.....	106
Video, viewing multiple inputs.....	441
View route plan	163
Visibility	248
Volume units.....	118, 410

W	
Warranty	25, 536
Waterline to tdcr	247
Waypoint	155
capacity.....	155
Capacity.....	166, 383
Delete	163
DSC.....	132
Edit.....	163
Goto.....	211–212, 299
List	104
Placement.....	315–316
Remove from route.....	163
Waypoint at Range and Bearing.....	365
Waypoint management	156
Waypoint, place from AR flag	465
Waypoints	
Delete	157
Details.....	158
Event groups.....	157
Group.....	156
Group list	157
List	156
LiveView	157
New group.....	157
Placing a waypoint.....	155–156
Sharing.....	165
Symbols	158
Weather	
Settings.....	272
Weather layers	264
Weather mode.....	263, 339
Animated weather	265
Animated weather layers.....	265
Cities layer	267
Cloud tops layer.....	267
Context menu	263
Lightning layer	267
Reports	263
Sea surface temperature layer	268
Storm cast.....	269
Storm tracks.....	269
Subscription.....	261, 272
Surface observation stations layer.....	267
Surface pressure.....	266
Surface pressure layer.....	268
Watchbox	270–271
Watchbox alerts	271
Wave direction.....	266, 271
Wave height.....	266
Wave Height	271
Wave period	266, 272
Weather radar.....	266
Weather radar layer	266
Wind.....	270
Wind arrows.....	270
Wind barbs.....	270
Wind direction.....	266, 270
Wind fields	270
Wind Radii.....	270
Wind speed.....	270
Weather Radar layer.....	245
WeatherMarine zone boundaries	272
WeatherWatchbox alerts	272
WeatherWatchbox range.....	272
WeatherWind symbol	272
Wi-Fi	
Settings.....	85
Wind	
Align wind transducer	74
Angle adjustment.....	74
Data type	145
Linearise transducer	74
Shift.....	145
Speed adjustment.....	74
Wind data	54, 396, 434
Wind shift.....	297
Wind shift bar	245, 293
Wind speed units.....	118, 410
Wind transducer	
Configuration	77
Wind vane mode	296
Tacking	298
Wireless display.....	124

Y

YachtSense	
Off-boat features.....	506
On-boat features.....	504
YachtSense app	94
YachtSense ecosystem	504
YachtSense Link	
IP address conflict.....	34, 84
Network connection	34, 84
Status.....	103
Yamaha app	
Controls	431
Yamaha app	93, 430–431
Advanced.....	438
data items	431
Data page	432
Engine instances reset.....	438
Engine page.....	431, 435
Engine trim.....	437
Fuel flow offset	439
Gateway reset.....	438
Overview.....	430
Requirements	431
Settings.....	438
Status	
Engine warming up	436
Immobilizer lock	437
Synchronization.....	437
Status indicator	436
Tanks	437
Tanks page	434
Transmission	436
Trim Calibration	439
Troll mode.....	438
Warning	
Catalyst	437
Check engine warning	437
Low oil pressure.....	437
Low voltage.....	437
Overheat	437
Steering system	437
Water in fuel.....	437

Warning indicator.....	437
Yamaha gateway.....	430
Yamaha HDMI	430
Yamaha HDMI app	93
YouTube	472
MFD controls	472
YouTube TV	472

Z

Zoom mode	
Fishfinder	316
Zoom view	317



Raymarine (UK / EU)

Marine House, Cartwright Drive,
Fareham, Hampshire.
PO15 5RJ.
United Kingdom.

Tel: (+44) (0)1329 246 700

www.raymarine.co.uk

Raymarine (US)

110 Lowell Road,
Hudson, NH 03051.
United States of America.

Tel: (+1) 603-324-7900

www.raymarine.com

Raymarine®